

STATE OF LOUISIANA
COASTAL PROTECTION AND RESTORATION
AUTHORITY

OYSTER BAYOU MARSH
RESTORATION PROJECT
CS-59 CAMERON PARISH

INDEX TO SHEETS

SHEET NO.	DESCRIPTION
1	TITLE SHEET
2	GENERAL NOTES
3	ALIGNMENT TABLES
4	EARTHEN TERRACE COORDINATE LOCATIONS AND MAGNETIC ANOMOLIES
5	PROJECT OVERVIEW
6	PLAN VIEW
7	MARSH CREATION PLAN VIEW
8	EARTHEN TERRACE PLAN VIEW
9	MARSH CREATION TYPICAL SECTIONS A-A' AND B-B'
10	MARSH CREATION TYPICAL SECTION C-C'
11	MARSH CREATION TYPICAL SECTION BL
12	MARSH CREATION TYPICAL SECTION D-D'
13-14	MARSH CREATION DETAILS
15	TYPICAL EARTHEN TERRACE DETAIL
16	TYPICAL EARTHEN TERRACE CROSS SECTION
17	BORROW AREA PLAN VIEW
18	BORROW AREA CROSS SECTION E-E'
19	BORROW AREA CROSS SECTION F-F'
20	LA 27/82 CROSSING PLAN VIEW AND PAVEMENT PATCH DETAIL
21	LA 27/82 TEMPORARY WATERLINE BYPASS PLAN AND DETAIL
22	LA 27/82 PERMANENT WATERLINE RELOCATION PLAN AND DETAIL
23	LA 27/82 PHASE 1 PLAN VIEW CASING PIPE INSTALLATION: SEQUENCE OF CONSTRUCTION
24	LA 27/82 PHASE 2 PLAN VIEW CASING PIPE INSTALLATION: SEQUENCE OF CONSTRUCTION
25	LA 27/82 PHASE 3 PLAN VIEW DREDGING OPERATIONS SEQUENCE OF CONSTRUCTION
26	LA 27/82 CROSSING OPEN CUT EXCAVATION SECTIONS G-G' AND H-H'
27	LA 27/82 WATERLINE RELOCATION DETAILS
28	LA 27/82 CROSSING PHASE 1 SECTION J-J' CASING PIPE INSTALLATION
29	LA 27/82 CROSSING PHASE 2 SECTION K-K' CASING PIPE INSTALLATION
30	TEMPORARY TRAFFIC CONTROL - TTC-00 (A)
31	TEMPORARY TRAFFIC CONTROL - TTC-00 (B)
32	TEMPORARY TRAFFIC CONTROL - TTC-00 (C)
33	TEMPORARY TRAFFIC CONTROL - TTC-00 (D)
34	TEMPORARY TRAFFIC CONTROL - TTC-02
35	TEMPORARY TRAFFIC CONTROL - TTC-04
36	TEMPORARY PIPELINE MARKER AND CASING PIPE CAP/MARKER DETAIL
37	SURVEY PROFILE LOCATIONS
38-42	EXISTING CONDITIONS PROFILES
43-53	MARSH CREATION CONSTRUCTION PROFILES
54-57	TERRACE FIELD CONSTRUCTION PROFILES
58	ACCESS ROUTES PLAN VIEW
59-60	ACCESS ROUTE "CL1"
61	ACCESS ROUTE "CL2"
62-65	ACCESS ROUTE "CL3"
66-69	ACCESS ROUTE "CL4"

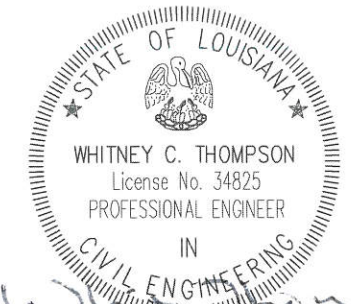
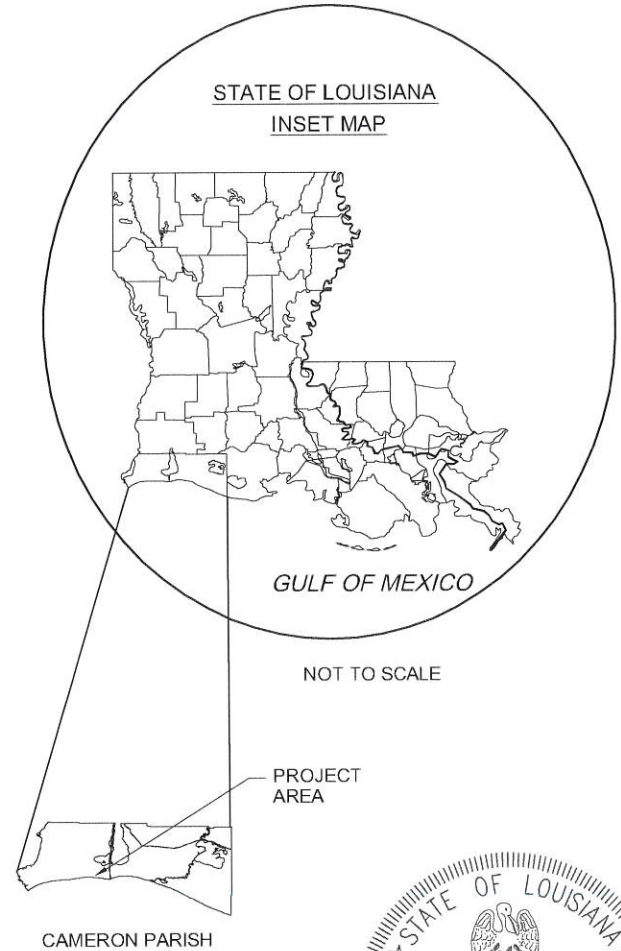
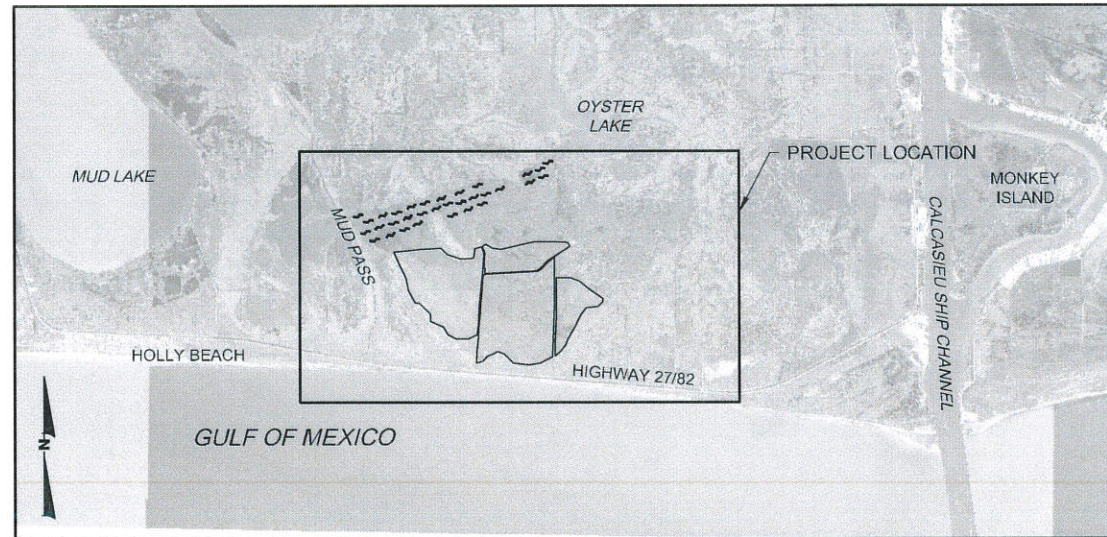

Whitney C. Thompson
6/27/16



Kodi C. Gullory
Kodi C. Gullory
ENGINEER MANAGER
PROJECT ENGINEER

REV.	DATE	DESCRIPTION	BY
1	6/27/16	REV. 1	WT

CB&I COASTAL PLANNING & ENGINEERING, INC.
2481 N.W. BOCA RATON BOULEVARD
BOCA RATON, FLORIDA 33431
PH. (561) 391-8102
FAX (561) 391-9116
C.O.A. FL. #4028
C.O.A. LA. #2531
www.CBI.COM

COASTAL PROTECTION AND RESTORATION AUTHORITY
450 LAUREL STREET
BATON ROUGE, LOUISIANA 70801
DRAWN BY: GK
DESIGNED BY: CP

OYSTER BAYOU MARSH RESTORATION PROJECT	TITLE SHEET
STATE PROJECT NUMBER: CS-59	
FEDERAL PROJECT NUMBER: CS-59	DATE: APRIL 13, 2016
APPROVED BY: WT	SHEET 1 OF 69

LICENSURE CLASSIFICATION
MAJOR CLASSIFICATION: HEAVY CONSTRUCTION
AND/OR SPECIALTY CLASSIFICATION: DREDGING

GENERAL NOTES:

- ALL ELEVATIONS ARE GIVEN IN THE NORTH AMERICAN VERTICAL DATUM OF 1988 (NAVD '88) U.S. SURVEY FEET (FEET), GEOID 2009. ALL HORIZONTAL COORDINATES ARE GIVEN IN THE NORTH AMERICAN DATUM OF 1983 (NAD '83, LOUISIANA STATE PLANE SOUTH ZONE) U.S. SURVEY FEET (FEET).
 - THE CONTRACTOR SHALL BE RESPONSIBLE FOR NAVIGATING FROM A NAVIGABLE WATER BODY TO THE PROJECT AREA. THE CONTRACTOR SHALL ALSO BE RESPONSIBLE FOR NAVIGATING WITHIN THE LIMITS OF THE PROJECT PLAN AREA. NO ACCESS DREDGING IS PERMITTED. THE CPRA PROJECT ENGINEER OR REPRESENTATIVE SHALL HAVE THE RIGHT TO MONITOR THE EQUIPMENT LOCATION DURING CONSTRUCTION.
 - ALL EQUIPMENT SHALL BE FLOATING AT ALL TIMES DURING THE TRANSIT TO AND FROM THE PROJECT SITE.
 - THE CONTRACTOR SHALL BE RESPONSIBLE FOR NOTIFYING LAND OWNERS AND PIPELINE AND UTILITY OPERATORS 10 WORKING DAYS PRIOR TO MOBILIZATION. ALL PIPELINES AND UNDERGROUND UTILITIES SHALL BE MARKED WITH BOUYS OR FLAGGED STAKES DURING CONSTRUCTION. IT IS THE CONTRACTOR'S RESPONSIBILITY TO MAINTAIN THE CLEARANCES FROM THE PIPELINES SET FORTH IN THE PLAN DRAWINGS OR IN THE BID DOCUMENTS. SEE SP-7 "LAND OWNER AND LEASE HOLDER REQUIREMENTS" AND TS-15.6 "SUBMERGED LINE APPROVALS." NO EXCAVATION IS ALLOWED WITHIN 50 FEET OF A PIPELINE UNLESS OTHERWISE STIPULATED IN AGREEMENT. THE FOLLOWING IS A LIST OF UTILITIES AND PIPELINE OPERATORS KNOWN TO HAVE PIPELINES IN THE VICINITY. PIPELINE LOCATIONS SHOWN ON THE PLANS ARE APPROXIMATIONS. THE OWNER IS NOT LIABLE FOR EXACT LOCATIONS. THE CONTRACTOR MUST CALL LOUISIANA ONE CALL AT 1-800-272-3020 AT LEAST 5 WORKING DAYS PRIOR TO MOBILIZATION.
- AMOCO PRODUCTION COMPANY/OLEUM OPERATING COMPANY**
 CONTACT: ANDREW SNELL
 PHONE: 903-758-9896
- CAMERON PARISH WATERWORKS**
 CONTACT: MARK YOUNG
 PHONE: 337-569-2110
- CAMERON COMMUNICATIONS (FIBER OPTIC LINE)**
 CONTACT: BOBBY BULT
 PHONE: 337-496-6530
- CHENIERE CREOLE TRAIL PIPELINE, LP**
 CONTACT: JOEY MAHMOUD
 PHONE: 713-375-5000
- DEPARTMENT OF ENERGY PIPELINE**
 CONTACT: DALE MARCANTEL
 PHONE: 337-558-3362
- KINETICA PARTNERS LLC**
 CONTACT: SHANE LOPEZ
 PHONE: 337-485-1825
- TARGA PIPELINE COMPANY**
 CONTACT: TODD MORRISON
 PHONE: 337-569-2307
- PLANS AND BID DOCUMENTS ARE COMPLEMENTARY; WHAT IS REQUIRED IN ONE IS AS BINDING AS IF REQUIRED BY ALL. CLARIFICATIONS AND INTERPRETATIONS OF, OR NOTIFICATIONS OF MINOR VARIATIONS AND DEVIATIONS IN THE CONTRACT DOCUMENTS WILL BE ISSUED BY THE ENGINEER.
 - ELEVATIONS SHOWN ON THE PLANS ARE BASED ON SURVEYS PERFORMED IN AUGUST AND SEPTEMBER OF 2012, AND MARCH 2015. THE SURVEYS WERE CONDUCTED BY LONNIE G. HARPER AND ASSOCIATES, INC. FOR CPRA. AN UPDATED PRE-CONSTRUCTION SURVEY WILL BE PERFORMED AS PART OF THIS CONTRACT, SEE TS-2.
 - THE ALIGNMENTS AND CONSTRUCTION VOLUMES MAY BE REVISED BY THE ENGINEER AT THE TIME OF CONSTRUCTION TO REFLECT CHANGES IN FIELD CONDITIONS.
 - ANY DAMAGE TO EXISTING U.S. COAST GUARD NAVIGATION AIDS OR PRIVATE NAVIGATION AIDS SHALL BE REPAIRED BY THE CONTRACTOR TO U.S. COAST GUARD STANDARDS AT THE EXPENSE OF THE CONTRACTOR.

- THE CONTRACTOR SHALL PERFORM A MAGNETOMETER SURVEY IN ALL AREAS OF EXCAVATION AND OTHER WORK THAT MAY POTENTIALLY DAMAGE OR INTERFERE WITH EXISTING INFRASTRUCTURE, PRIOR TO ANY WORK. LOCATION OF INFRASTRUCTURE (PIPELINES, WELL HEADS, ETC.) ARE PROVIDED IN THE CONTRACT DOCUMENTS FOR INFORMATIONAL PURPOSES ONLY. SEE TS-2.
- UPON COMPLETION OF THE PROJECT, THE PRIMARY DIKE SHALL BE DEGRADED. THE CONTRACTOR SHALL EXERCISE CARE TO MAINTAIN THE PRIMARY DIKES AT THE DESIGN ELEVATION DURING THE PROJECT AND SHALL PREVENT ANY BREACHES OF THE DIKES FOR THE DURATION OF THE PROJECT. THE CPRA MAY REQUEST SOME LOCALIZED DIKE DEGRADATION AT THE END OF THE PROJECT.
- AVOIDING IMPACTS TO EXISTING VEGETATION: FOR PROTECTION OF EXISTING VEGETATION, ACCESS TO OR MOVEMENT ACROSS THE PROJECT AREA OUTSIDE OF THE DEFINED PROJECT AREA SHALL GENERALLY BE PROHIBITED WITHIN VEGETATED AREAS FOR ALL PERSONNEL AND EQUIPMENT. VEGETATED AREAS SHALL NOT BE USED FOR EQUIPMENT, PERSONNEL OR MATERIAL ACCESS OR STORAGE. THE DREDGED FILL SHALL BE DISCHARGED WITHIN THE CONTAINED AREAS IN A MANNER THAT WILL MINIMIZE OVERFLOW OF THE DREDGED MATERIAL FROM THE BOUNDS OF ITS PLACEMENT AREA.

SETTLEMENT PLATE LOCATIONS			
LABEL	EASTING	NORTHING	LOCATION
MARSH CREATION AREA 1			
SP-1	2,620,912.8	472,256.6	DIKE
SP-2	2,622,191.6	470,095.6	MARSH
MARSH CREATION AREA 2			
SP-3	2,624,668.4	471,595.2	MARSH
MARSH CREATION AREA 3			
SP-4	2,624,235.5	470,595.1	MARSH
SP-5	2,624,807.3	469,095.4	MARSH
MARSH CREATION AREA 4			
SP-6	2,627,298.5	470,595.8	MARSH
SP-7	2,627,318.8	469,096.3	DIKE

NOTE: COORDINATES ARE IN STATE PLANE, NAD 1983, LOUISIANA SOUTH ZONE, U.S. SURVEY FEET

PROPOSED MARSH DEWATERING LOCATIONS		
LABEL	EASTING	NORTHING
MARSH CREATION AREA 1		
DL-1	2,619,945.3	471,986.9
	2,620,074.4	472,195.9
DL-2	2,623,207.0	472,293.5
	2,623,455.7	472,371.8
MARSH CREATION AREA 2		
DL-3	2,624,783.8	472,399.0
	2,625,027.5	472,454.3
DL-4	2,626,393.3	472,584.5
	2,626,642.9	472,570.7
MARSH CREATION AREA 3		
DL-5	2,624,008.1	471,275.9
	2,624,257.9	471,286.4
DL-6	2,626,566.9	470,404.8
	2,626,562.2	470,154.9
MARSH CREATION AREA 4		
	2,627,275.7	471,029.1
	2,627,506.3	470,932.5

- NOTES:
- COORDINATES ARE IN STATE PLANE, NAD 1983, LOUISIANA SOUTH ZONE, U.S. SURVEY FEET.
 - SEE TS-16 OF CONSTRUCTION SPECIFICATIONS.
 - RECOMMENDED DEWATERING GENERAL LOCATIONS ARE SHOWN IN TABLE. FINAL LOCATIONS DETERMINED IN FIELD.

SUMMARY OF ESTIMATED QUANTITIES			
ITEM	DESCRIPTION	UNIT	ESTIMATED QUANTITY
1	MOBILIZATION AND DEMOBILIZATION	LUMP SUM	1
2	PRE-CONSTRUCTION SURVEYS	LUMP SUM	1
3	AS-BUILT SURVEYS	LUMP SUM	1
4	HYDRAULIC DREDGING - MARSH CREATION	CUBIC YARD	3,481,700
5	PRIMARY CONTAINMENT DIKES	LINEAR FOOT	45,041
6	SECONDARY POND CONTAINMENT	LINEAR FOOT	2,543
7	TRENASSES	LINEAR FOOT	9,491
8	EARTHEN TERRACES	LINEAR FOOT	17,550
9	SETTLEMENT PLATES	EACH	7
10	TEMPORARY WATERLINE BYPASS	LUMP SUM	1
11	WATERLINE RELOCATION	LUMP SUM	1
12	TRAFFIC CONTROL	LUMP SUM	1
13	HIGHWAY CROSSING MOBILIZATION	LUMP SUM	1
14	HIGHWAY EMBANKMENT (DOTD 203-03-00100)	CUBIC YARD	270
15	HIGHWAY EXCAVATION (DOTD 203-01-00100)	CUBIC YARD	470
16	GEOTEXTILE FABRIC (DOTD 203-08-00100)	SQUARE YARD	63
17	PAVEMENT PATCHING 12 IN THICK (DOTD 510-01-00100)	SQUARE YARD	63
18	BEDDING MATERIAL (DOTD 726-01-00100)	CUBIC YARD	11
19	CONCRETE DRAIN PIPE (51" O.D. CONCRETE PIPE) (DOTD 701-01-N)	LINEAR FOOT	43
20	FLOWABLE FILL (DOTD 710-01-00100)	CUBIC YARD	115
21	PLASTIC PAVEMENT MARKINGS (SOLID LINE)(4" WIDTH)(DOTD 732-02-00100)	LINEAR FOOT	80
22	PLASTIC PAVEMENT MARKINGS (BROKEN LINE)(4" WIDTH)(DOTD 732-03-00100)	LINEAR FOOT	40
23	RAISED PAVEMENT MARKERS (DOTD 731-02-00100)	EACH	4
24	CASING PIPE CAP	EACH	2

NOTE: QUANTITIES ARE ESTIMATES BASED ON SURVEYS CONDUCTED IN AUGUST 2012, SEPTEMBER 2012, AND MARCH 2015. WHERE THE QUANTITY OF WORK WITH RESPECT TO ANY ITEM IS COVERED BY A UNIT PRICE, SUCH AS QUANTITIES ARE ESTIMATED QUANTITIES TO BE USED WHEN COMPARING BIDS AND THE RIGHT IS RESERVED BY THE OWNER TO INCREASE/ DECREASE SUCH QUANTITIES AS MAY BE NECESSARY TO COMPLETE THE WORK AND REMAIN WITHIN FUNDING LIMITS. IN THE EVENT OF MATERIAL OVERUNS/ UNDERUNS BY LESS THAN TWENTY-FIVE PERCENT (25%), THE BID UNIT COSTS WILL BE USED TO DETERMINE PAYMENT TO THE CONTRACTOR. IF THE ACTUAL QUANTITY OF THE UNIT-PRICED ITEM VARIES MORE THAN TWENTY-FIVE PERCENT (25%) ABOVE OR BELOW THE ESTIMATED QUANTITY, AN EQUITABLE ADJUSTMENT IN THE CONTRACT PRICE SHALL BE MADE UPON DEMAND OF EITHER PARTY.

TIDAL DATUMS AT CALCASIEU PASS, LOUISIANA	
TIDAL DATUM	ELEVATION
MEAN HIGH WATER (MHW)	1.34
MEAN LOW WATER (MLW)	0.65

SOURCE: CPRA CRMS0655-H01 NOTE: ELEVATIONS ARE REFERENCED TO NAVD 1988, U.S. SURVEY FEET, GEOID 2009.

BASELINE		
BEND POINT	EASTING	NORTHING
P.O.B	2,625,411.4	466,992.2
P.O.E	2,625,411.4	474,781.6

NOTE: COORDINATES ARE IN STATE PLANE, NAD 1983, LOUISIANA SOUTH ZONE, U.S. SURVEY FEET

BENCHMARK CONTROL POINT			
MONUMENT	LATITUDE	LONGITUDE	ELEVATION
CS-20-SM-03	2,625,833.2	486,444.9	4.2

NOTE: MONUMENT IS LOCATED NEAR THE INTERSECTION OF STEP CANAL AND MUD BAYOU AND NOT WITHIN THE PROJECT AREA SHOWN IN THE PLANS. COORDINATES ARE IN STATE PLANE, NAD 1983, LOUISIANA SOUTH ZONE, U.S. SURVEY FEET. ELEVATIONS ARE REFERENCED TO NAVD 1988, U.S. SURVEY FEET, GEOID 1999.

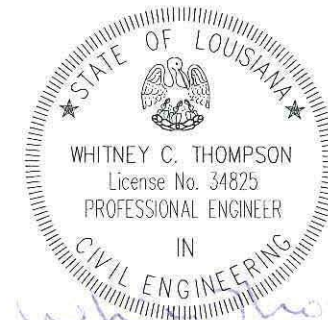

REV.	DATE	DESCRIPTION	BY
1	6-17-16		WT

CB&I COASTAL PLANNING & ENGINEERING, INC.
 2481 N.W. BOCA RATON BOULEVARD
 BOCA RATON, FLORIDA 33431
 PH. (561) 391-8102
 FAX (561) 391-9116
 C.O.A. FL #4028
 C.O.A. LA #2531
 www.CBI.com

COASTAL PROTECTION AND RESTORATION AUTHORITY
 450 LAUREL STREET
 BATON ROUGE, LOUISIANA 70801
 DRAWN BY: GK
 DESIGNED BY: CP

OYSTER BAYOU MARSH RESTORATION PROJECT
 STATE PROJECT NUMBER: CS-59
 FEDERAL PROJECT NUMBER: CS-59
 APPROVED BY: WT

GENERAL NOTES
 DATE: APRIL 13, 2016
 SHEET 2 OF 69

PRIMARY DIKE CENTERLINE INFLECTION POINTS	
EASTNG	NORTHING
MARSH CREATION AREA 1	
2,619,869.4	472,180.9
2,623,154.4	471,923.8
2,620,459.1	472,227.5
2,620,911.5	472,254.5
2,621,770.2	472,322.4
2,621,982.3	472,094.9
2,622,032.0	472,052.7
2,622,597.6	471,877.7
2,623,047.1	471,895.0
2,623,205.5	472,294.8
2,623,450.6	472,373.7
2,623,554.4	472,126.5
2,623,518.9	471,594.9
2,623,467.8	471,094.9
2,623,431.0	470,594.9
2,623,342.3	470,243.4
2,623,377.5	470,094.9
2,623,345.1	469,594.9
2,623,300.1	469,094.9
2,623,271.9	468,744.3
2,622,925.6	468,596.0
2,622,411.4	468,593.9
2,622,072.6	468,763.8
2,621,868.0	469,094.9
2,621,358.8	469,317.2
2,621,373.3	469,594.9
2,620,917.6	470,054.3
2,620,717.3	470,096.3
2,620,470.0	470,599.0
2,620,345.8	471,094.9
2,620,121.7	471,594.9
2,619,898.8	472,094.9

PRIMARY DIKE CENTERLINE INFLECTION POINTS	
EASTNG	NORTHING
MARSH CREATION AREA 2	
2,623,501.9	472,399.8
2,627,029.6	472,551.5
2,623,617.2	472,493.7
2,623,911.6	472,315.3
2,624,270.6	472,280.8
2,625,414.2	472,542.2
2,625,691.4	472,595.6
2,626,203.5	472,595.6
2,626,911.4	472,553.9
2,627,082.3	472,432.1
2,626,903.7	472,298.8
2,626,623.9	472,105.2
2,626,327.3	471,931.7
2,626,122.7	471,758.8
2,625,980.3	471,604.0
2,625,836.1	471,469.0
2,625,742.1	471,418.1
2,625,411.4	471,392.8
2,623,911.4	471,319.2
2,623,617.2	471,318.5
2,623,625.3	471,500.3
2,623,586.9	471,532.9
2,623,578.0	471,594.9
2,623,609.9	472,094.2
2,623,612.7	472,174.7

PRIMARY DIKE CENTERLINE INFLECTION POINTS	
EASTNG	NORTHING
MARSH CREATION AREA 3	
2,623,541.2	471,206.6
2,626,144.8	471,682.6
2,623,593.3	471,250.1
2,623,663.1	471,260.4
2,623,912.1	471,270.3
2,625,411.4	471,344.9
2,625,814.2	471,367.4
2,625,867.8	471,391.7
2,626,053.3	471,594.9
2,626,214.2	471,749.8
2,626,257.1	471,791.9
2,626,341.1	471,856.1
2,626,390.9	471,895.4
2,626,463.2	471,934.8
2,626,466.0	471,594.9
2,626,460.2	471,094.9
2,626,454.2	470,595.2
2,626,447.2	470,095.1
2,626,434.6	469,595.2
2,626,420.7	469,095.2
2,626,407.8	468,595.3
2,626,387.8	468,095.1
2,626,388.3	467,840.8
2,625,885.0	467,594.3
2,625,411.2	467,501.8
2,624,782.2	467,593.1
2,624,411.2	467,951.4
2,624,115.3	468,064.7
2,623,912.2	467,958.6
2,623,681.3	467,887.4
2,623,511.4	467,671.1
2,623,249.4	467,598.2
2,623,284.0	468,094.9
2,623,325.0	468,594.9
2,623,366.3	469,094.9
2,623,421.0	469,594.9
2,623,459.9	470,094.9
2,623,501.7	470,594.9
2,623,532.0	471,093.9

PRIMARY DIKE CENTERLINE INFLECTION POINTS	
EASTNG	NORTHING
MARSH CREATION AREA 4	
2,626,575.8	471,094.3
2,627,765.2	469,890.6
2,626,911.5	471,093.0
2,627,118.6	471,094.3
2,627,506.0	470,931.9
2,627,936.9	470,594.9
2,628,445.3	470,223.8
2,628,425.7	470,094.9
2,628,245.3	469,937.5
2,627,556.5	469,594.9
2,627,315.5	469,094.9
2,627,024.2	468,594.9
2,626,904.4	468,333.9
2,626,727.5	468,094.9
2,626,507.7	467,890.7
2,626,508.8	468,094.9
2,626,523.3	468,594.9
2,626,538.8	469,094.9
2,626,554.3	469,594.9
2,626,563.4	470,094.9
2,626,572.6	470,594.9

TRENASSE INFLECTION POINTS	
EASTING	NORTHING
MARSH CREATION AREA 1	
2,621,341.9	472,233.4
2,621,202.9	472,025.0
2,621,176.7	471,889.3
2,621,264.9	471,769.3
2,621,624.6	471,695.8
2,621,745.5	471,597.2
2,621,722.0	471,496.7
2,621,713.6	471,237.4
2,622,032.1	471,211.6
2,622,125.1	471,169.0
2,622,125.1	471,046.5
2,622,094.0	471,019.8
2,622,027.2	470,704.3
2,622,053.2	470,626.4
2,622,465.7	470,240.1
2,622,791.4	470,240.1
2,623,237.5	470,461.4
2,623,346.1	470,700.9
2,623,303.8	470,834.5
2,623,105.6	470,919.4
2,623,006.0	471,146.8
2,623,137.6	471,342.1
2,623,354.1	471,416.6
2,623,448.1	471,415.7
MARSH CREATION AREA 2	
2,623,677.3	471,531.1
2,623,845.9	471,586.8
2,623,983.4	471,554.9
2,624,065.3	471,432.8
2,624,088.9	471,379.8
2,624,341.4	472,240.9
2,624,346.3	472,197.5
2,624,311.9	472,172.9
2,624,108.0	472,136.1
2,624,056.4	471,902.8
2,624,095.7	471,627.8
2,624,100.6	471,401.8
2,624,104.8	471,380.6
MARSH CREATION AREA 3	
2,624,135.4	471,227.1
2,624,135.0	471,227.5
2,624,464.2	470,896.0
2,624,532.9	470,449.1
2,624,223.4	469,638.7
2,624,223.4	469,324.4
2,624,459.8	468,885.5
2,624,883.8	468,668.6
2,625,216.3	468,817.1

NOTE: COORDINATES ARE IN STATE PLANE, NAD 1983, LOUISIANA SOUTH ZONE, U.S. SURVEY FEET

POND INFLECTION POINTS		
CONTAINMENT	EASTING	NORTHING
MARSH CREATION AREA 1		
SECONDARY POND	2,621,039.3	471,527.1
DIKE	2,621,104.9	471,221.5
MARSH EGDE	2,621,382.9	471,342.6
CONTAINMENT	2,621,478.2	471,281.1
SECONDARY POND	2,621,601.3	471,072.7
DIKE	2,621,756.2	471,338.6
MARSH EGDE	2,621,752.2	471,406.1
CONTAINMENT	2,621,774.1	471,487.4
	2,621,684.7	471,503.3
	2,621,551.7	471,503.3
	2,621,363.0	471,596.5
	2,621,271.7	471,552.9
	2,621,261.7	471,515.2
	2,621,178.3	471,493.4
	2,621,150.5	471,521.1
MARSH EGDE	2,622,763.0	470,506.0
CONTAINMENT	2,623,081.9	470,506.0
	2,623,139.3	470,445.5
	2,623,183.9	470,461.4
	2,623,327.4	470,461.4
	2,623,356.1	470,340.3
	2,623,406.0	470,335.1
	2,623,394.7	470,226.5
	2,623,314.6	470,251.1
SECONDARY POND	2,623,268.6	470,043.9
DIKE	2,622,995.8	470,008.9
MARSH EGDE	2,622,941.5	470,165.1
CONTAINMENT	2,622,788.5	470,241.5
	2,622,788.5	470,359.4
	2,622,890.5	470,349.9
	2,622,896.9	470,439.1
MARSH CREATION AREA 3		
MARSH EGDE	2,625,235.6	469,378.9
CONTAINMENT	2,625,288.7	469,401.4
	2,625,387.0	469,381.8
	2,625,496.9	469,258.9
	2,625,542.5	469,149.4
	2,625,527.7	469,018.2
	2,625,528.8	468,918.7
SECONDARY POND	2,625,462.0	468,841.7
DIKE	2,625,378.3	468,799.9
	2,625,318.1	468,782.0
	2,625,229.1	468,822.9
	2,625,206.5	468,876.0
	2,625,205.1	468,919.7
	2,625,217.4	468,981.2
	2,625,210.5	469,036.2
	2,625,143.6	469,123.7
	2,625,130.3	469,198.0
	2,625,149.5	469,268.3

NOTE: COORDINATES ARE IN STATE PLANE, NAD 1983, LOUISIANA SOUTH ZONE, U.S. SURVEY FEET

MARSH CHECK PROFILES				
BASLINE STATION	EASTING	NORTHING	AZIMUTH	PERPENDICUAR DISTANCE TO NEXT STATION (FT)
85+00	2,625,411.4	467,594.9	270	500
80+00	2,625,411.4	468,094.9	270	500
75+00	2,625,411.4	468,594.9	270	500
70+00	2,625,411.4	469,094.9	270	500
65+00	2,625,411.4	469,594.9	270	500
60+00	2,625,411.4	470,094.9	270	500
55+00	2,625,411.4	470,594.9	270	500
50+00	2,625,411.4	471,094.9	270	500
45+00	2,625,411.4	471,594.9	270	500
40+00	2,625,411.4	472,094.9	270	500
35+00	2,625,411.4	472,594.9	270	500

NOTE: COORDINATES ARE IN STATE PLANE, NAD 1983, LOUISIANA SOUTH ZONE, U.S. SURVEY FEET

TERRACE FIELD (TF) SURVEY PROFILES		
TF PROFILE NO.	EASTING	NORTHING
TF1-P.O.B.	2,618,035.0	473,657.5
TF1-P.O.E.	2,618,259.1	472,933.1
TF2-P.O.B.	2,618,414.0	474,124.2
TF2-P.O.E.	2,618,943.8	472,411.7
TF3-P.O.B.	2,618,940.6	474,113.8
TF3-P.O.E.	2,619,412.1	472,589.8
TF4-P.O.B.	2,619,460.0	474,126.7
TF4-P.O.E.	2,619,880.4	472,768.0
TF5-P.O.B.	2,619,901.3	474,391.7
TF5-P.O.E.	2,620,355.7	472,923.1
TF6-P.O.B.	2,620,419.4	474,409.1
TF6-P.O.E.	2,620,833.4	473,070.9
TF7-P.O.B.	2,620,902.4	474,539.4
TF7-P.O.E.	2,621,311.0	473,218.7
TF8-P.O.B.	2,621,347.2	474,793.5
TF8-P.O.E.	2,621,788.7	473,366.5
TF9-P.O.B.	2,621,858.7	474,831.9
TF9-P.O.E.	2,622,266.4	473,514.3
TF10-P.O.B.	2,622,320.2	475,031.9
TF10-P.O.E.	2,622,744.0	473,662.1
TF11-P.O.B.	2,622,817.3	475,116.8
TF11-P.O.E.	2,623,221.7	473,809.9
TF12-P.O.B.	2,623,258.5	475,382.3
TF12-P.O.E.	2,623,699.3	473,957.7
TF13-P.O.B.	2,623,800.5	475,322.3
TF13-P.O.E.	2,624,177.0	474,105.5
TF14-P.O.B.	2,624,379.1	475,143.8
TF14-P.O.E.	2,624,551.4	474,586.9
TF15-P.O.B.	2,624,881.1	475,213.1
TF15-P.O.E.	2,625,002.4	474,821.0
TF16-P.O.B.	2,625,222.4	475,801.4
TF16-P.O.E.	2,625,485.2	474,952.1
TF17-P.O.B.	2,625,697.6	475,957.1
TF17-P.O.E.	2,625,968.1	475,083.1
TF18-P.O.B.	2,626,128.1	476,257.5
TF18-P.O.E.	2,626,450.9	475,214.2

NOTE: COORDINATES ARE IN STATE PLANE, NAD 1983, LOUISIANA SOUTH ZONE, U.S. SURVEY FEET

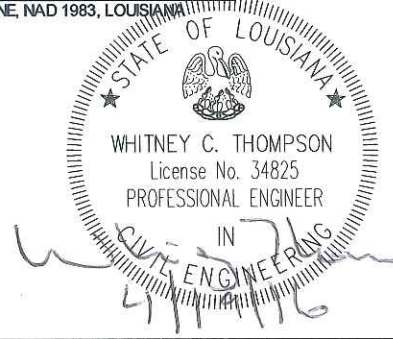

REV.	DATE	DESCRIPTION	BY

CB&I COASTAL PLANNING & ENGINEERING, INC.
 2481 N.W. BOCA RATON BOULEVARD
 BOCA RATON, FLORIDA 33431
 PH. (561) 391-8102
 FAX (561) 391-9116
 C.O.A. FL. #4028
 C.O.A. LA. #2531
 www.CBI.COM

COASTAL PROTECTION AND RESTORATION AUTHORITY
 450 LAUREL STREET
 BATON ROUGE, LOUISIANA 70801
 DRAWN BY: GK
 DESIGNED BY: CP

OYSTER BAYOU MARSH RESTORATION PROJECT
 STATE PROJECT NUMBER: CS-59
 FEDERAL PROJECT NUMBER: CS-59
 APPROVED BY: WT
 ALIGNMENT TABLES
 DATE: APRIL 13, 2016
 SHEET 3 OF 69

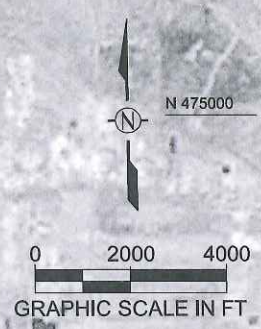

- LEGEND:**
- PL — PIPELINE
 - SPL — APPROXIMATE SURVEY PIPELINE
 - FO — FIBER OPTIC LINE
 - WL — WATER LINE

- NOTES:**
1. COORDINATES ARE IN FEET BASED ON LOUISIANA STATE PLANE COORDINATE SYSTEM, SOUTH ZONE, NORTH AMERICAN DATUM OF 1983 (NAD83).
 2. DATE OF AERIAL IMAGERY: 2013.
 3. EARTHEN TERRACES SHALL BE CONSTRUCTED TO AVOID EXISTING VEGETATED WETLANDS.
 4. LOCATIONS OF PIPELINES SHOWN IN PLANS ARE APPROXIMATE. PIPELINE APPROXIMATE SURVEY LOCATIONS WERE PROVIDED BY INFRASTRUCTURE OWNERS. OTHER PIPELINES ARE FROM VARIOUS DATABASES. CONTRACTOR SHALL VERIFY EXACT LOCATION OF ALL PIPELINES WITHIN PROJECT AREA, ALONG CONVEYANCE CORRIDOR, WITHIN BORROW AREA, OR WORK LIMITS PRIOR TO EXCAVATION. CONTRACTOR SHALL OBTAIN AN AGREEMENT WITH THE OWNER OR OPERATOR OF ANY PIPELINE TO BE CROSSED BY A SUBMERGED SEDIMENT PIPELINE.
 5. AFTER PRE-CONSTRUCTION SURVEY, THE CONTRACTOR SHALL PROVIDE A REVISED EARTHEN TERRACE LAYOUT TO THE ENGINEER FOR APPROVAL PRIOR TO CONSTRUCTION.
 6. PONDS SHALL BE CONTAINED BY NATURAL FEATURES TO THE EXTENT POSSIBLE. CONTAINMENT IS NOT SHOWN NEAR EXISTING MARSH. EXISTING MARSH SHALL BE USED AS CONTAINMENT WHERE POSSIBLE.

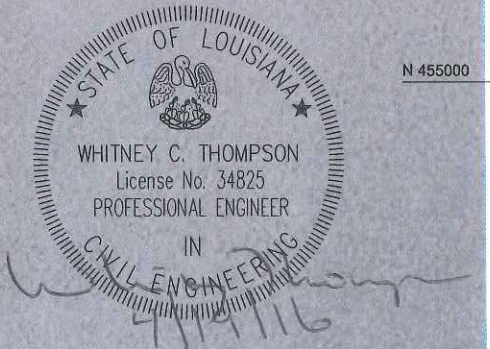

SUBMERGED PIPELINE CORRIDOR COORDINATE LOCATIONS		
Pt. No.	EASTING	NORTHING
1	2622952.2	467029.6
2	2623380.9	466996.0
3	2623065.9	462969.8
4	2632907.6	447855.2
5	2632896.4	447088.3
6	2622626.1	462861.0

REV.	DATE	DESCRIPTION	BY

CB&I COASTAL PLANNING & ENGINEERING, INC.
 2481 N.W. BOCA RATON BOULEVARD
 BOCA RATON, FLORIDA 33431
 PH. (561) 391-8102
 FAX (561) 391-9116
 C.O.A. FL. #4028
 C.O.A. LA. #2531
 www.CBI.COM

COASTAL PROTECTION AND RESTORATION AUTHORITY
 450 LAUREL STREET
 BATON ROUGE, LOUISIANA 70801
 DRAWN BY: GK
 DESIGNED BY: CP

OYSTER BAYOU MARSH RESTORATION PROJECT
 STATE PROJECT NUMBER: CS-59
 FEDERAL PROJECT NUMBER: CS-59
 APPROVED BY: WT

PROJECT OVERVIEW
 DATE: APRIL 13, 2016
 SHEET 5 OF 69

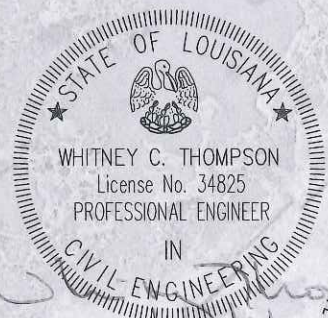
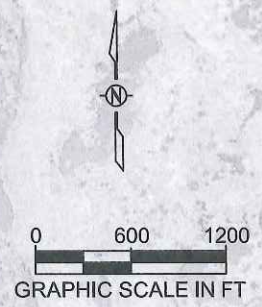
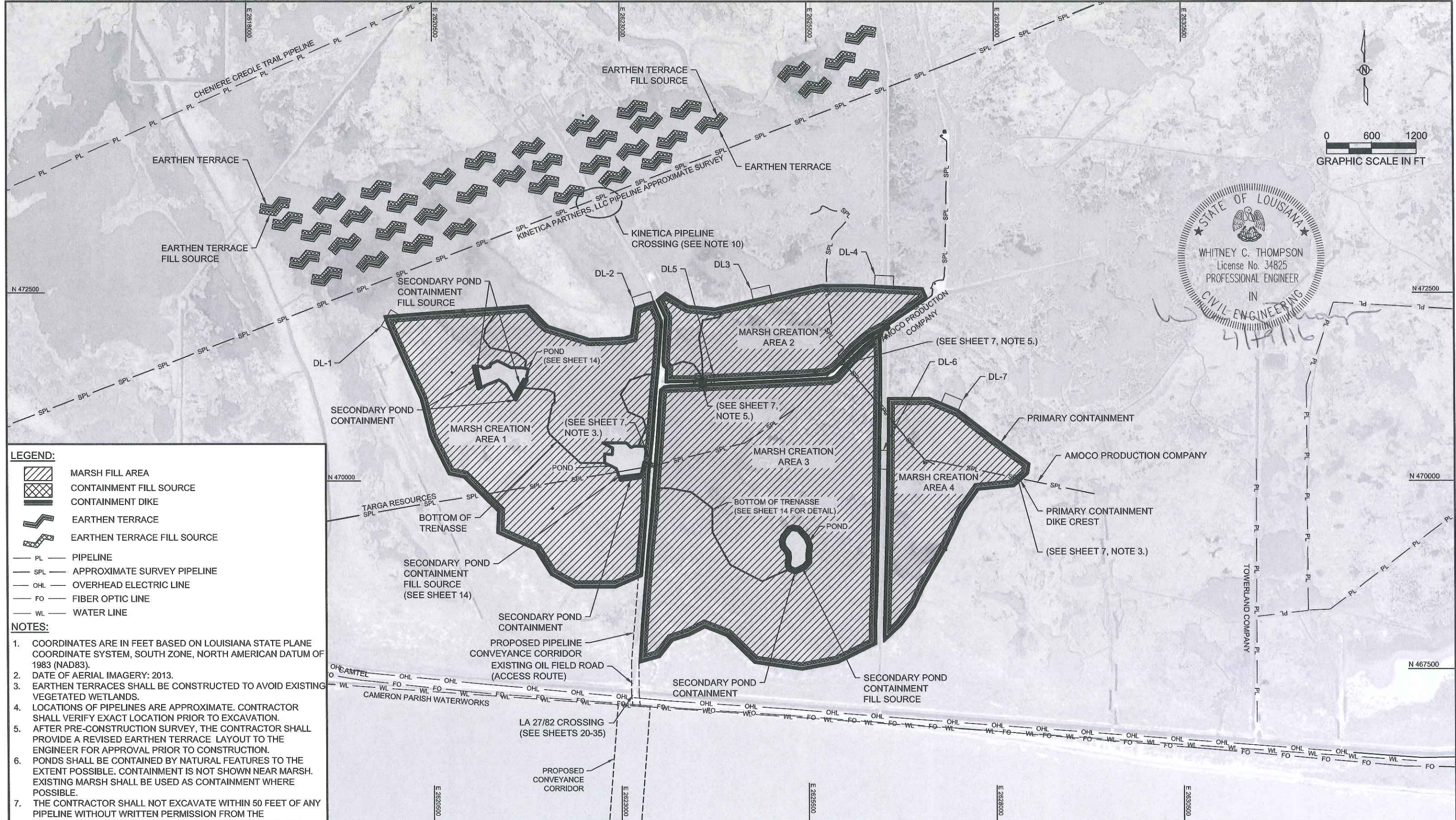

- LEGEND:**
- MARSH FILL AREA
 - CONTAINMENT FILL SOURCE
 - CONTAINMENT DIKE
 - EARTHEN TERRACE
 - EARTHEN TERRACE FILL SOURCE
 - PIPELINE
 - APPROXIMATE SURVEY PIPELINE
 - OVERHEAD ELECTRIC LINE
 - FIBER OPTIC LINE
 - WATER LINE

- NOTES:**
1. COORDINATES ARE IN FEET BASED ON LOUISIANA STATE PLANE COORDINATE SYSTEM, SOUTH ZONE, NORTH AMERICAN DATUM OF 1983 (NAD83).
 2. DATE OF AERIAL IMAGERY: 2013.
 3. EARTHEN TERRACES SHALL BE CONSTRUCTED TO AVOID EXISTING VEGETATED WETLANDS.
 4. LOCATIONS OF PIPELINES ARE APPROXIMATE. CONTRACTOR SHALL VERIFY EXACT LOCATION PRIOR TO EXCAVATION. AFTER PRE-CONSTRUCTION SURVEY, THE CONTRACTOR SHALL PROVIDE A REVISED EARTHEN TERRACE LAYOUT TO THE ENGINEER FOR APPROVAL PRIOR TO CONSTRUCTION.
 5. PONDS SHALL BE CONTAINED BY NATURAL FEATURES TO THE EXTENT POSSIBLE. CONTAINMENT IS NOT SHOWN NEAR MARSH. EXISTING MARSH SHALL BE USED AS CONTAINMENT WHERE POSSIBLE.
 6. THE CONTRACTOR SHALL NOT EXCAVATE WITHIN 50 FEET OF ANY PIPELINE WITHOUT WRITTEN PERMISSION FROM THE INFRASTRUCTURE OWNER. SEE SP-7 OF THE CONSTRUCTION SPECIFICATIONS.
 7. SEE SHEET 2 FOR COORDINATES OF MARSH DEWATERING LOCATIONS.
 8. RECOMMENDED DEWATERING GENERAL LOCATIONS. FINAL LOCATIONS DETERMINED IN FIELD.
 9. TRACKED EQUIPMENT MAY TRAVERSE THE EXISTING KINETIC PIPELINE AT THE OIL FIELD CROSSING. SEE SP-7 OF THE CONSTRUCTION SPECIFICATIONS.

REV.	DATE	DESCRIPTION	BY

CB&I COASTAL PLANNING & ENGINEERING, INC.
 2481 N.W. BOCA RATON BOULEVARD
 BOCA RATON, FLORIDA 33431
 PH. (561) 391-8102
 FAX (561) 391-9116
 C.O.A. FL. #4028
 C.O.A. LA. #2531
 www.CBI.COM

COASTAL PROTECTION AND RESTORATION AUTHORITY
 450 LAUREL STREET
 BATON ROUGE, LOUISIANA 70801
 DRAWN BY: GK
 DESIGNED BY: CP

OYSTER BAYOU MARSH RESTORATION PROJECT
 STATE PROJECT NUMBER: CS-59
 FEDERAL PROJECT NUMBER: CS-59
 APPROVED BY: WT

PLAN VIEW
 DATE: APRIL 13, 2016
 SHEET 6 OF 69

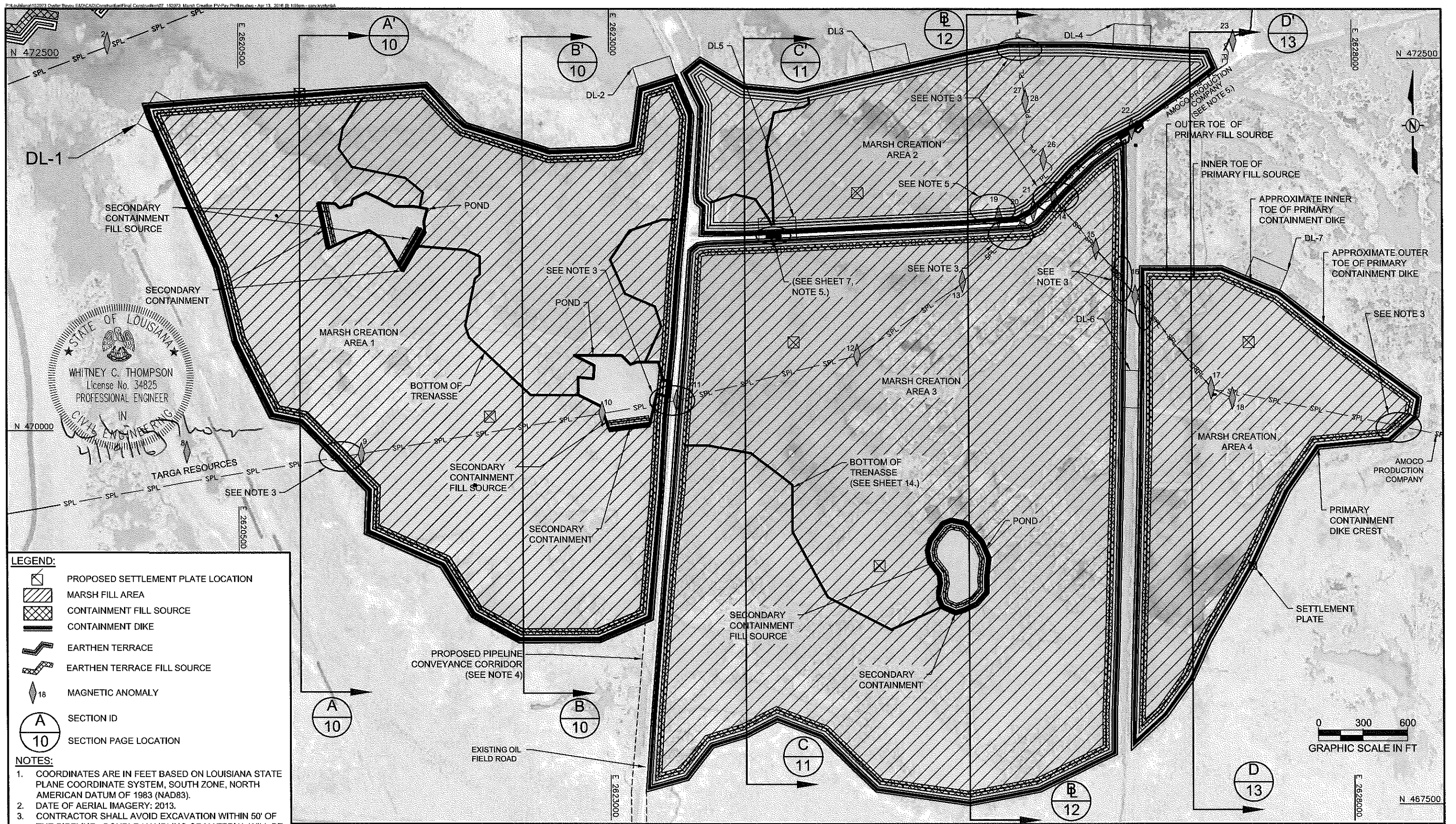

LEGEND:

- PROPOSED SETTLEMENT PLATE LOCATION
- MARSH FILL AREA
- CONTAINMENT FILL SOURCE
- CONTAINMENT DIKE
- EARTHEN TERRACE
- EARTHEN TERRACE FILL SOURCE
- MAGNETIC ANOMALY
- SECTION ID
- SECTION PAGE LOCATION

NOTES:

- COORDINATES ARE IN FEET BASED ON LOUISIANA STATE PLANE COORDINATE SYSTEM, SOUTH ZONE, NORTH AMERICAN DATUM OF 1983 (NAD83).
- DATE OF AERIAL IMAGERY: 2013.
- CONTRACTOR SHALL AVOID EXCAVATION WITHIN 50' OF THE PIPELINE. DOUBLE-HANDLING OF MATERIAL WILL BE NECESSARY TO CONSTRUCT CONTAINMENT AT THESE LOCATIONS.
- CONTRACTOR SHALL NOT TRAVERSE ACROSS EXISTING VEGETATION. THE LIMIT OF THE PIPELINE CONVEYANCE CORRIDOR SHALL BE THE WORK LIMITS.
- CONTRACTOR SHALL COORDINATE WITH CPRA WHEN WORKING AROUND EXISTING BRIDGE STRUCTURE AND ELEVATED AMOCO PIPELINE.

REV.	DATE	DESCRIPTION	BY







CB&I COASTAL PLANNING & ENGINEERING, INC.
 2481 N.W. BOCA RATON BOULEVARD
 BOCA RATON, FLORIDA 33431
 PH. (561) 391-8102
 FAX (561) 391-9116
 C.O.A. FL. #4028
 C.O.A. LA. #2531
 www.CBI.COM

COASTAL PROTECTION AND RESTORATION AUTHORITY
 450 LAUREL STREET
 BATON ROUGE, LOUISIANA 70801
 DRAWN BY: GK
 DESIGNED BY: CP

OYSTER BAYOU MARSH RESTORATION PROJECT
 STATE PROJECT NUMBER: CS-59
 FEDERAL PROJECT NUMBER: CS-59
 APPROVED BY: WT

MARSH CREATION PLAN VIEW
 DATE: APRIL 13, 2016
 SHEET 7 OF 69

LEGEND:

-  EARTHEN TERRACE
-  FILL SOURCE
-  PIPELINE
-  SURVEYED PIPELINE LOCATION
-  T-25 EARTHEN TERRACE IDENTIFICATION NUMBER (SEE SHEET 4 FOR COORDINATE LOCATIONS)
-  18 MAGNETIC ANOMALIES (SEE SHEET 4 FOR COORDINATE LOCATIONS)

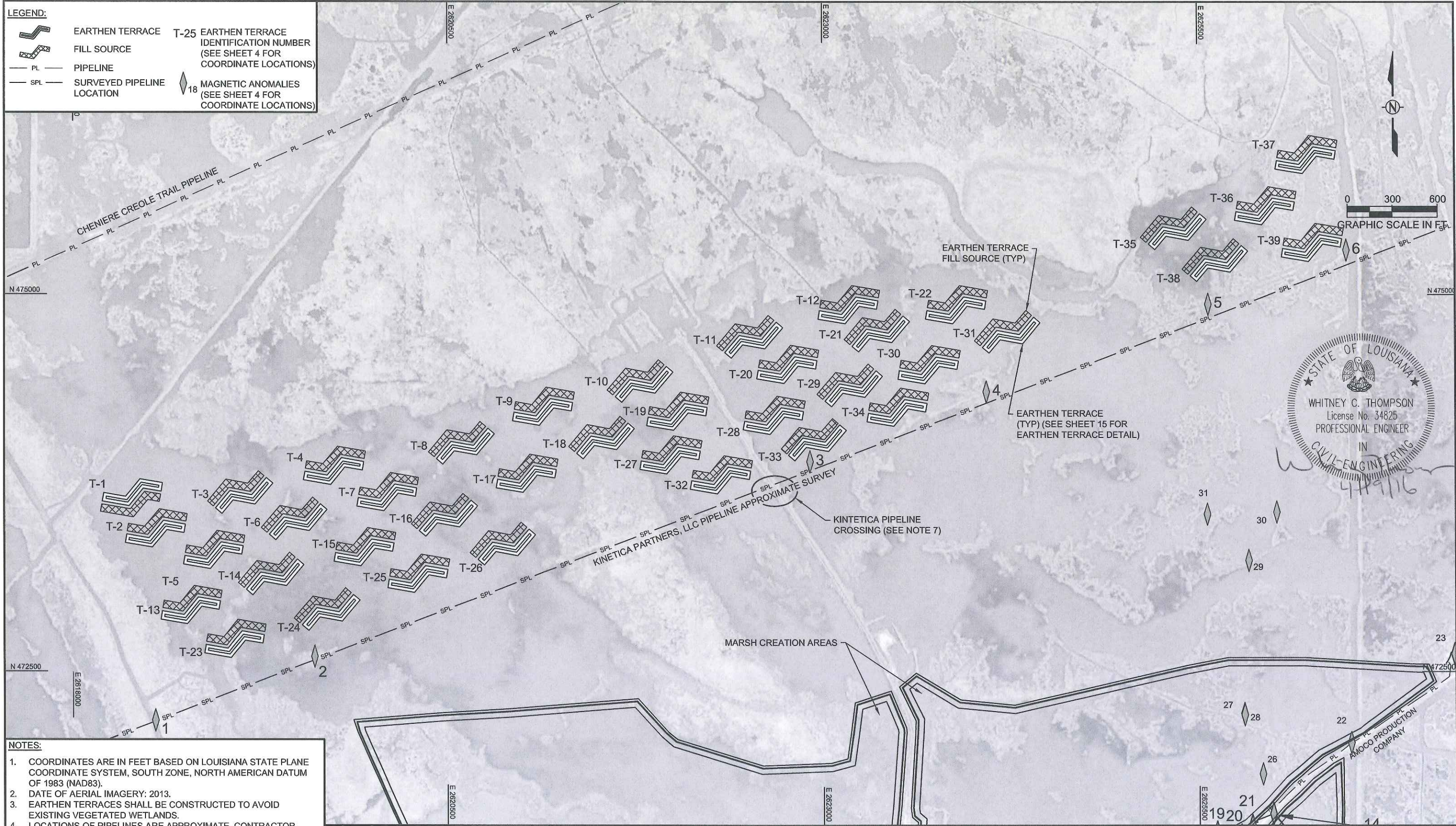

STATE OF LOUISIANA

 WHITNEY C. THOMPSON
 License No. 34825
 PROFESSIONAL ENGINEER
 IN
 CIVIL ENGINEERING
 4/19/16

NOTES:

1. COORDINATES ARE IN FEET BASED ON LOUISIANA STATE PLANE COORDINATE SYSTEM, SOUTH ZONE, NORTH AMERICAN DATUM OF 1983 (NAD83).
2. DATE OF AERIAL IMAGERY: 2013.
3. EARTHEN TERRACES SHALL BE CONSTRUCTED TO AVOID EXISTING VEGETATED WETLANDS.
4. LOCATIONS OF PIPELINES ARE APPROXIMATE. CONTRACTOR SHALL VERIFY EXACT LOCATION PRIOR TO EXCAVATION.
5. AFTER PRE-CONSTRUCTION SURVEY, THE CONTRACTOR SHALL PROVIDE A REVISED EARTHEN TERRACE LAYOUT TO THE ENGINEER FOR APPROVAL PRIOR TO CONSTRUCTION.
6. SEE SHEET 4 FOR EARTHEN TERRACE COORDINATES.
7. TRACKED EQUIPMENT MAY TRAVERSE THE EXISTING KINETICA PIPELINE AT THE OIL FIELD CROSSING. SEE SP-7 OF THE CONSTRUCTION SPECIFICATIONS.

REV.	DATE	DESCRIPTION	BY

<p>CB&I COASTAL PLANNING & ENGINEERING, INC. 2481 N.W. BOCA RATON BOULEVARD BOCA RATON, FLORIDA 33431</p> <p>PH. (561) 391-8102 FAX (561) 391-9116</p> <p>C.O.A. FL. #4028 C.O.A. LA. #2531 www.CBI.COM</p>	<p>COASTAL PROTECTION AND RESTORATION AUTHORITY 450 LAUREL STREET BATON ROUGE, LOUISIANA 70801</p>	<p>OYSTER BAYOU MARSH RESTORATION PROJECT</p> <p>STATE PROJECT NUMBER: CS-59</p> <p>FEDERAL PROJECT NUMBER: CS-59</p> <p>APPROVED BY: WT</p>	<p>EARTHEN TERRACE PLAN VIEW</p> <p>DATE: APRIL 13, 2016</p> <p>SHEET 8 OF 69</p>
<p>DRAWN BY: GK</p>	<p>DESIGNED BY: CP</p>		

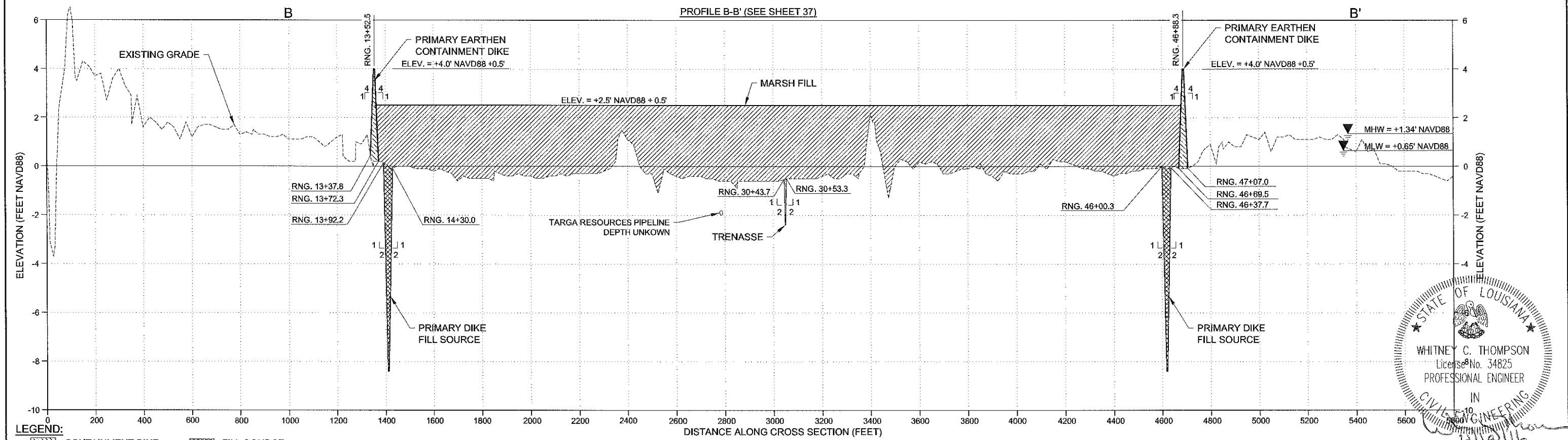
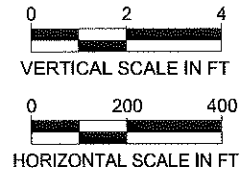
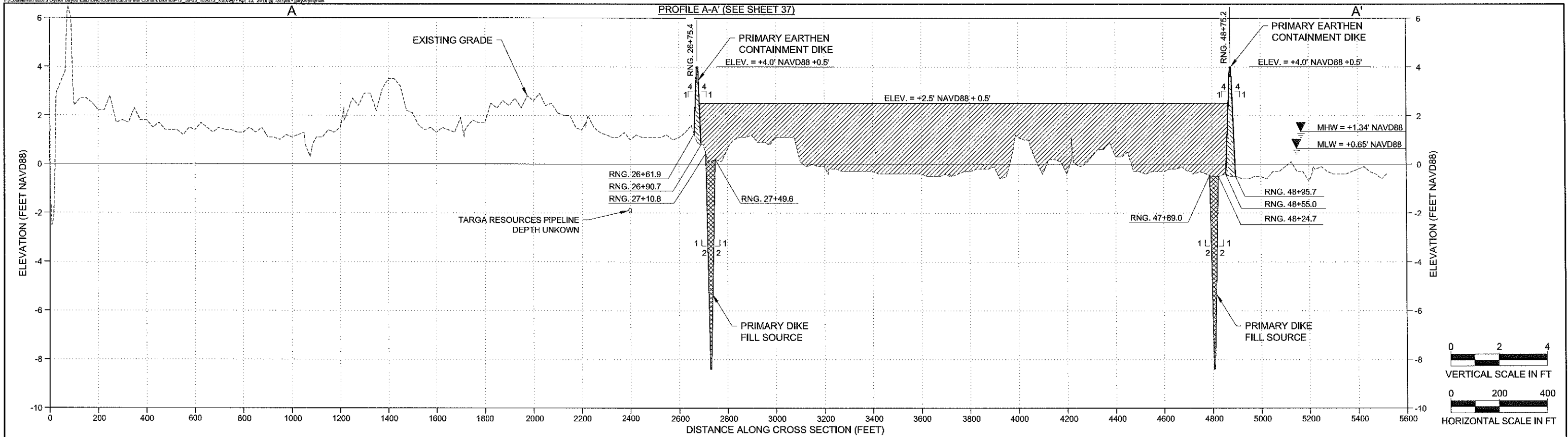

- LEGEND:**
- CONTAINMENT DIKE
 - MARSH FILL
 - FILL SOURCE
 - TRENCH
- NOTES:**
1. ELEVATIONS SHOWN HEREON ARE IN FEET BASED ON NAVD 1988.
 2. DISTANCES ARE ALONG SECTION LINE.
 3. LOCATIONS OF PIPELINES ARE APPROXIMATE. CONTRACTOR SHALL VERIFY EXACT LOCATION PRIOR TO EXCAVATION.
 4. NO EXCAVATION IS ALLOWED WITHIN 50 FEET OF A PIPELINE.

REV.	DATE	DESCRIPTION	BY

CB&I COASTAL PLANNING & ENGINEERING, INC.
 2481 N.W. BOCA RATON BOULEVARD
 BOCA RATON, FLORIDA 33431
 PH. (561) 391-8102
 FAX (561) 391-9116
 C.O.A. FL. #4028
 C.O.A. LA. #2531
 www.CBI.COM

COASTAL PROTECTION AND RESTORATION AUTHORITY
 450 LAUREL STREET
 BATON ROUGE, LOUISIANA 70801
 DRAWN BY: GK
 DESIGNED BY: CP

OYSTER BAYOU MARSH RESTORATION PROJECT
 STATE PROJECT NUMBER: CS-59
 FEDERAL PROJECT NUMBER: CS-59
 APPROVED BY: WT

MARSH CREATION TYPICAL SECTIONS A-A' AND B-B'
 DATE: APRIL 13, 2016
 SHEET 9 OF 69

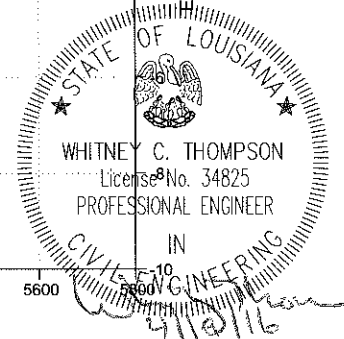

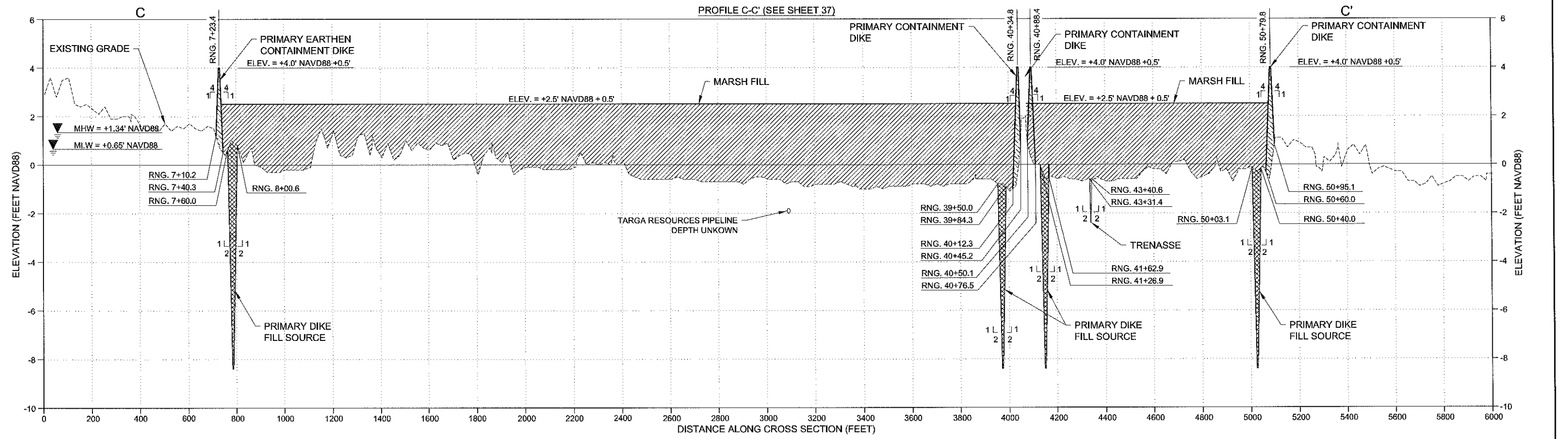

- LEGEND:**
- CONTAINMENT DIKE
 - MARSH FILL
 - FILL SOURCE
 - TRENASSE

- NOTES:**
1. ELEVATIONS SHOWN HEREON ARE IN FEET BASED ON NAVD 1988.
 2. DISTANCES ARE ALONG SECTION LINE.
 3. LOCATIONS OF PIPELINES ARE APPROXIMATE. CONTRACTOR SHALL VERIFY EXACT LOCATION PRIOR TO EXCAVATION.
 4. NO EXCAVATION IS ALLOWED WITHIN 50 FEET OF A PIPELINE.

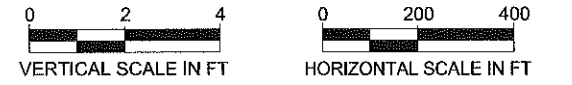
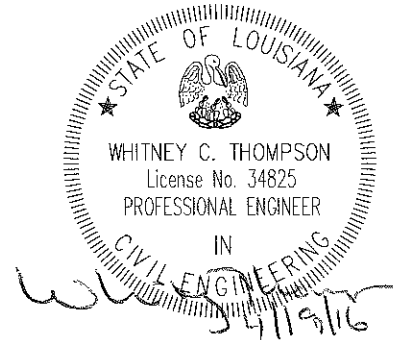

		CB&I COASTAL PLANNING & ENGINEERING, INC. 2481 N.W. BOCA RATON BOULEVARD BOCA RATON, FLORIDA 33431		PH. (561) 391-8102 FAX (561) 391-8116		COASTAL PROTECTION AND RESTORATION AUTHORITY 450 LAUREL STREET BATON ROUGE, LOUISIANA 70801		OYSTER BAYOU MARSH RESTORATION PROJECT		MARSH CREATION TYPICAL SECTION C-C'	
				C.O.A. FL #4028 C.O.A. LA #2531 www.CBI.COM		DRAWN BY: GK		DESIGNED BY: CP		APPROVED BY: WT	
								STATE PROJECT NUMBER: CS-59		DATE: APRIL 13, 2016	
								FEDERAL PROJECT NUMBER: CS-59		SHEET 10 OF 69	
REV.	DATE	DESCRIPTION	BY								

PROFILE BL (SEE SHEET 37)

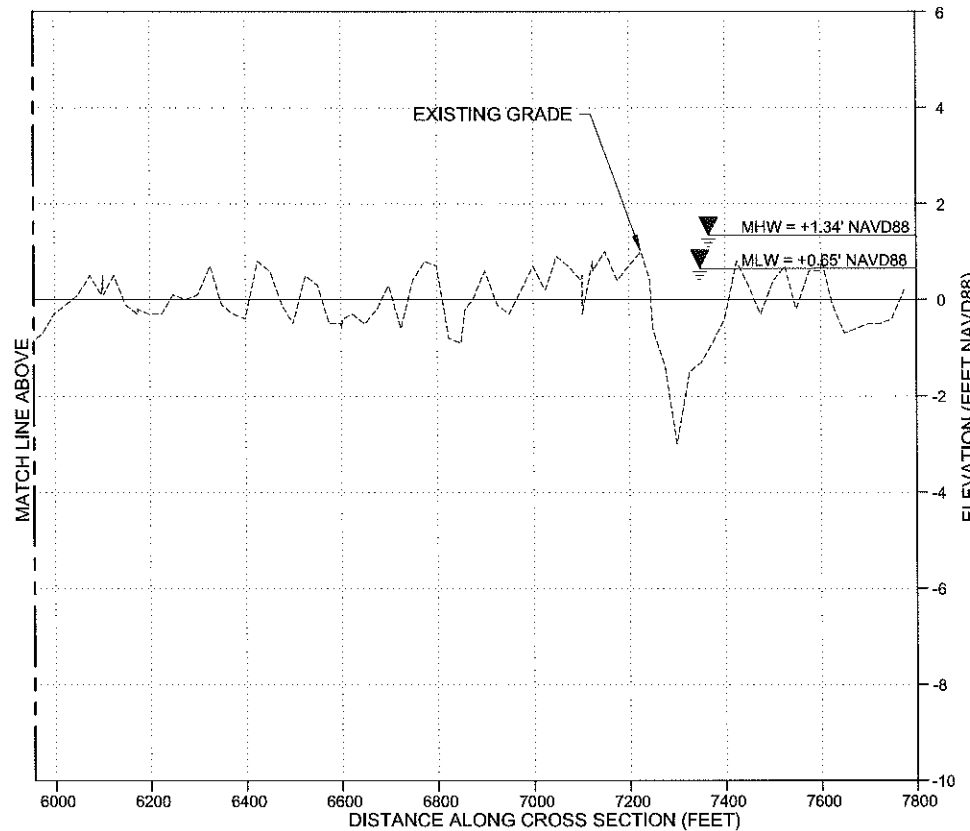
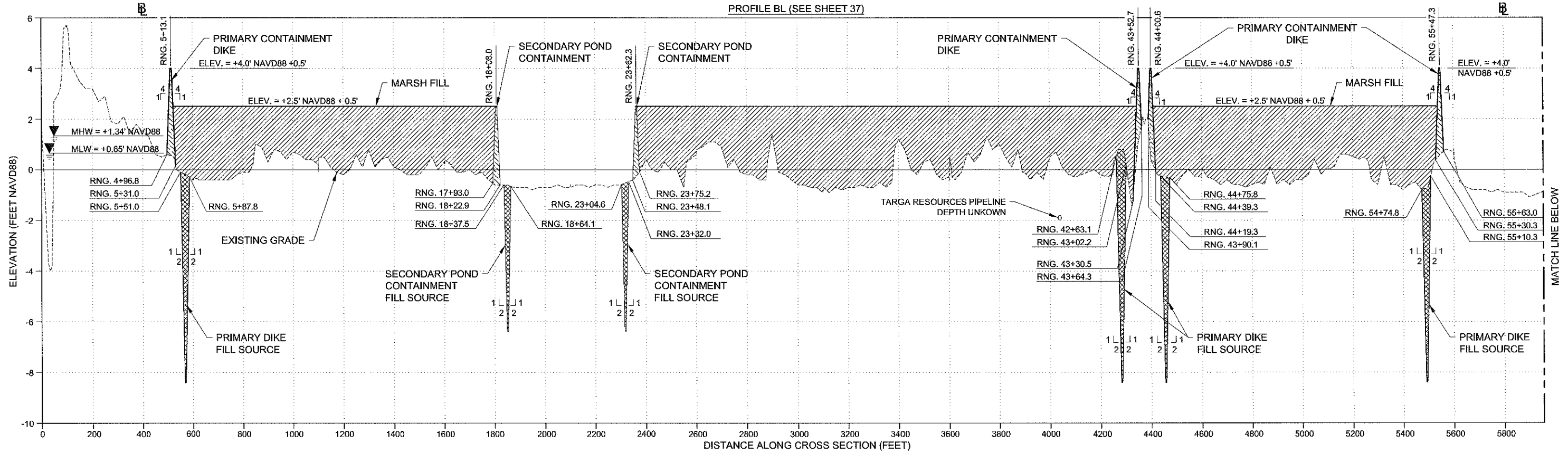

LEGEND:

- CONTAINMENT DIKE
- MARSH FILL
- FILL SOURCE
- TRENASSE

NOTES:

1. ELEVATIONS SHOWN HEREON ARE IN FEET BASED ON NAVD 1988.
2. DISTANCES ARE ALONG SECTION LINE.
3. LOCATIONS OF PIPELINES ARE APPROXIMATE. CONTRACTOR SHALL VERIFY EXACT LOCATION PRIOR TO EXCAVATION.
4. NO EXCAVATION IS ALLOWED WITHIN 50 FEET OF A PIPELINE.

REV.	DATE	DESCRIPTION	BY

CB&I COASTAL PLANNING & ENGINEERING, INC.

2481 N.W. BOCA RATON BOULEVARD
BOCA RATON, FLORIDA 33431

PH. (561) 391-8102
FAX (561) 391-8116

C.O.A. FL. #4028
C.O.A. LA. #2531
www.CBI.COM

COASTAL PROTECTION AND RESTORATION AUTHORITY

450 LAUREL STREET
BATON ROUGE, LOUISIANA 70801

DRAWN BY: GK

DESIGNED BY: CP

OYSTER BAYOU MARSH RESTORATION PROJECT

STATE PROJECT NUMBER: CS-59

FEDERAL PROJECT NUMBER: CS-59

APPROVED BY: WT

MARSH CREATION TYPICAL SECTION BL

DATE: APRIL 13, 2016

SHEET 11 OF 69

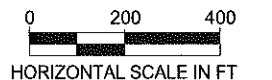
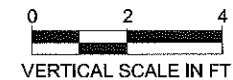
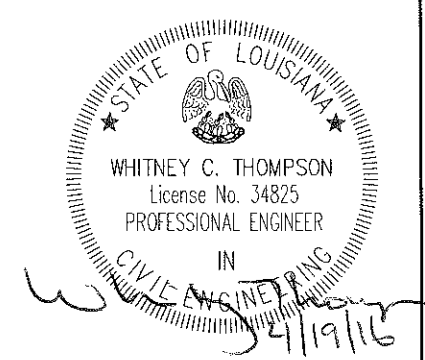

PROFILE D-D' (SEE SHEET 37)

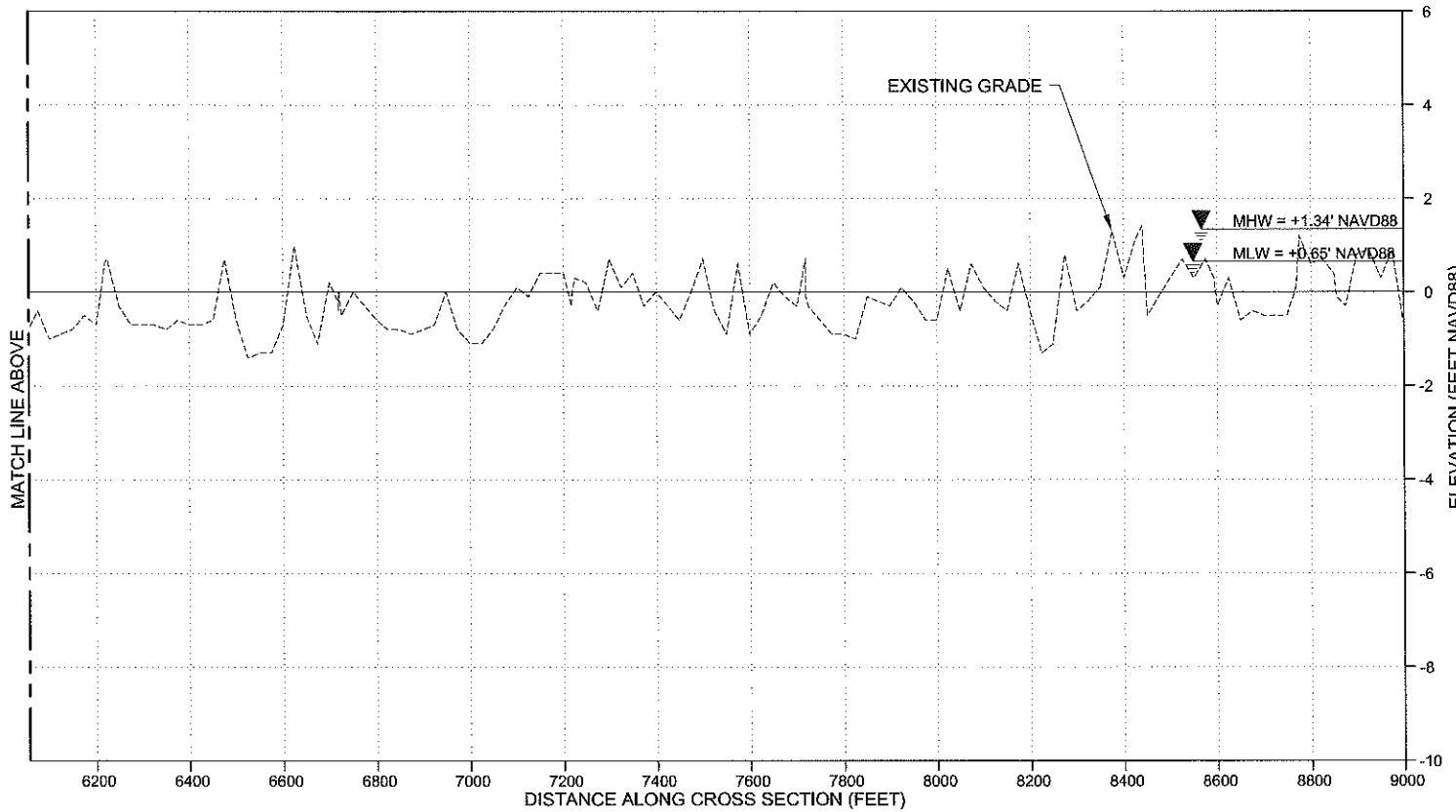
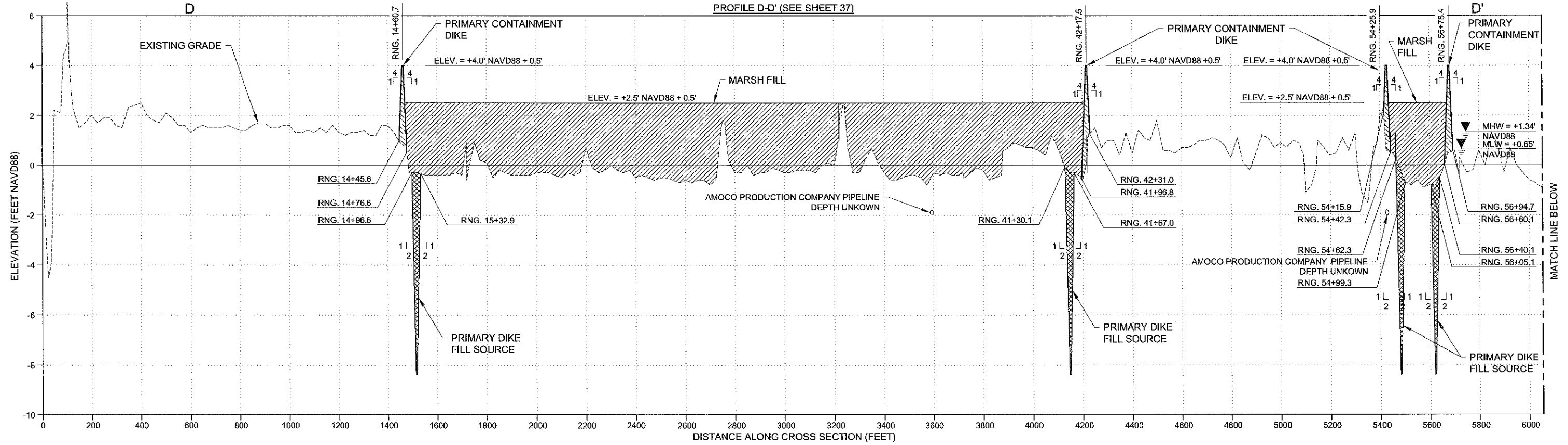

- LEGEND:**
- CONTAINMENT DIKE
 - MARSH FILL
 - FILL SOURCE

- NOTES:**
1. ELEVATIONS SHOWN HEREON ARE IN FEET BASED ON NAVD 1988.
 2. DISTANCES ARE ALONG SECTION LINE.
 3. LOCATIONS OF PIPELINES ARE APPROXIMATE. CONTRACTOR SHALL VERIFY EXACT LOCATION PRIOR TO EXCAVATION.
 4. NO EXCAVATION IS ALLOWED WITHIN 50 FEET OF A PIPELINE.

REV.	DATE	DESCRIPTION	BY

CB&I COASTAL PLANNING & ENGINEERING, INC.
 2481 N.W. BOCA RATON BOULEVARD
 BOCA RATON, FLORIDA 33431
 PH. (561) 391-8102
 FAX (561) 391-9116
 C.O.A. FL. #4028
 C.O.A. LA. #2531
 www.CBI.COM

COASTAL PROTECTION AND RESTORATION AUTHORITY
 450 LAUREL STREET
 BATON ROUGE, LOUISIANA 70801

DRAWN BY: GK DESIGNED BY: CP

OYSTER BAYOU MARSH RESTORATION PROJECT

STATE PROJECT NUMBER: CS-59
 FEDERAL PROJECT NUMBER: CS-59

APPROVED BY: WT

MARSH CREATION TYPICAL SECTION D-D'

DATE: APRIL 13, 2016

SHEET 12 OF 69

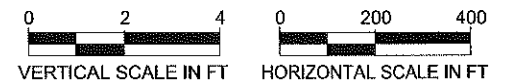
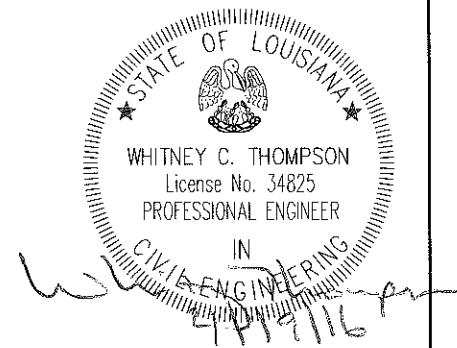

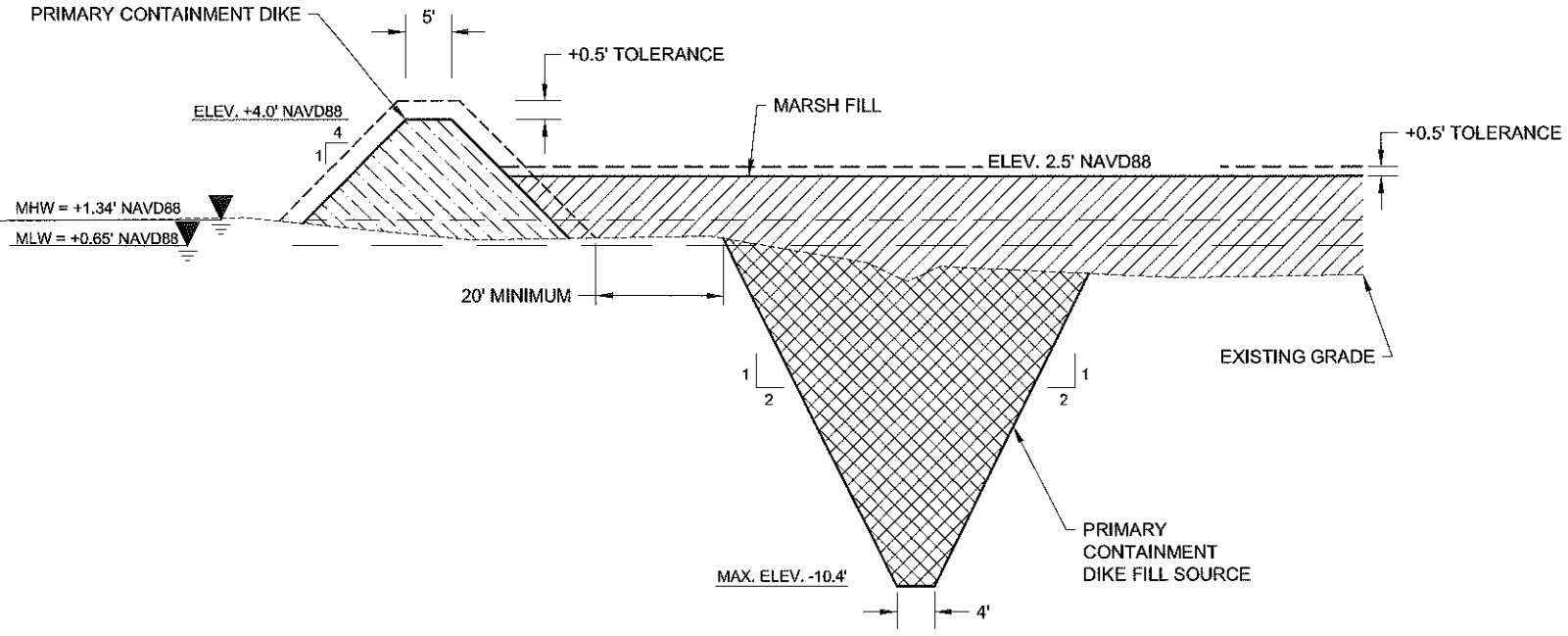

TYPICAL PRIMARY CONTAINMENT DIKE SECTION
NOT TO SCALE

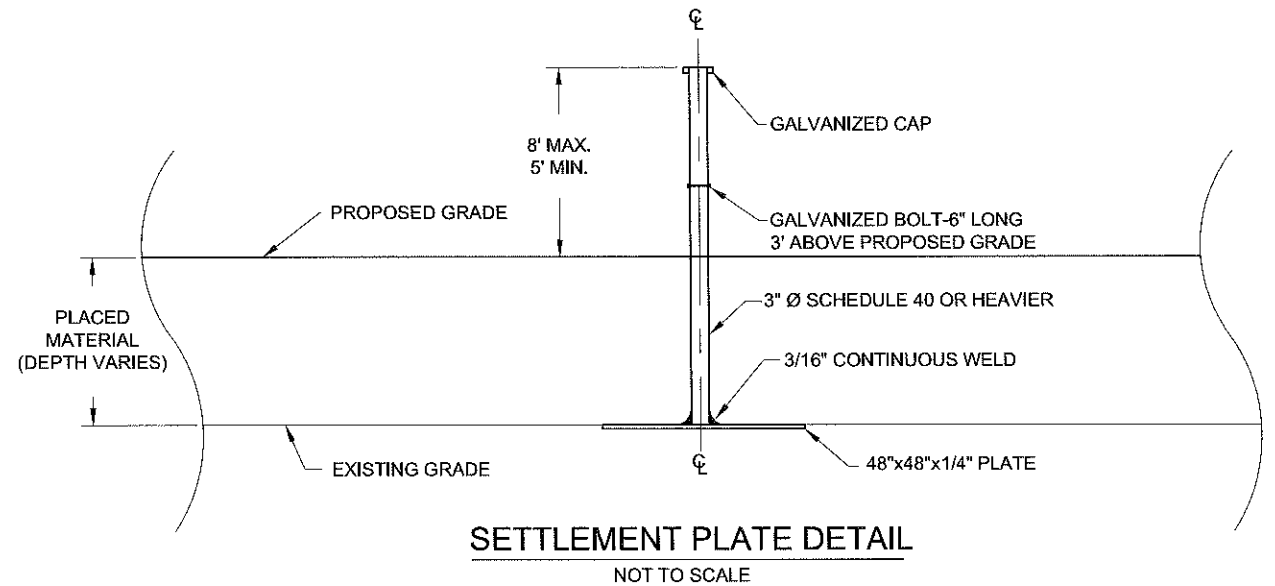

NOTES:
1. SETTLEMENT PLATES SHALL BE BUILT USING ASTM A36 STEEL AND HOT-DIPPED GALVANIZED AFTER FABRICATION. A 6\"/>

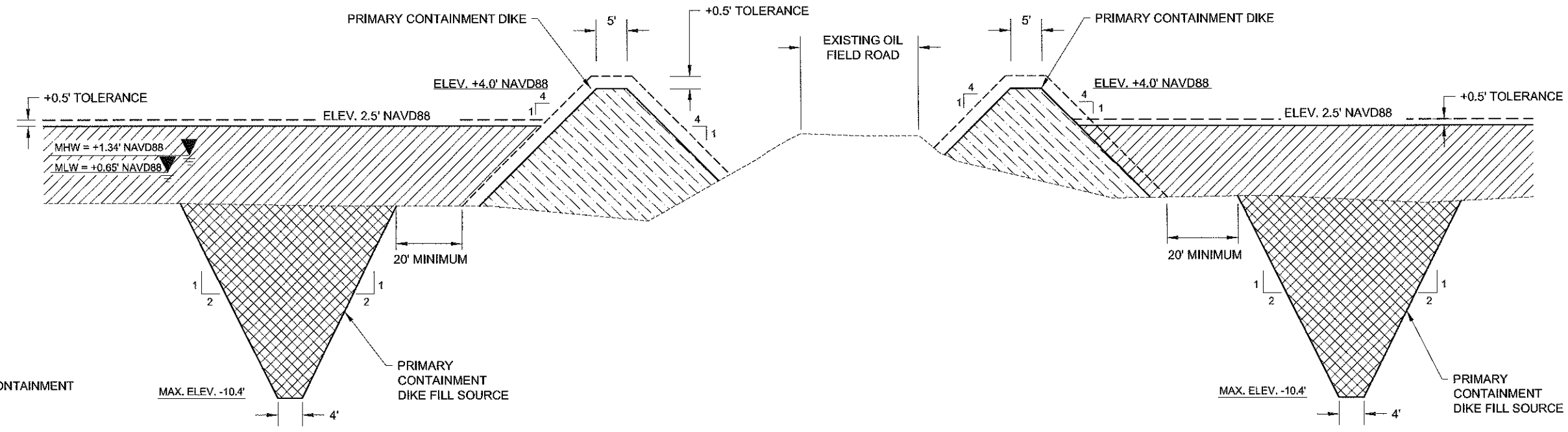

TYPICAL PRIMARY CONTAINMENT DIKE ADJACENT TO EXISTING OIL FIELD ROAD (STA. 55+00)
NOT TO SCALE

- LEGEND:**
- PRIMARY CONTAINMENT DIKE FILL
 - MARSH FILL
 - PRIMARY CONTAINMENT DIKE FILL SOURCE

NOTES:
1. ELEVATIONS SHOWN HEREON ARE IN FEET BASED ON NAVD 1988.

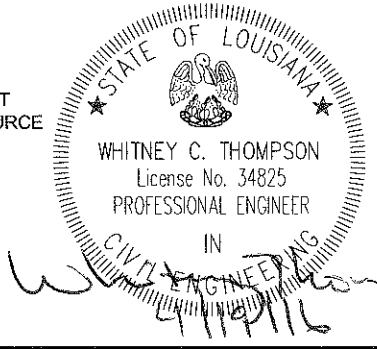

		CB&I COASTAL PLANNING & ENGINEERING, INC. 2481 N.W. BOCA RATON BOULEVARD BOCA RATON, FLORIDA 33431		PH. (561) 391-8102 FAX (561) 391-9116		COASTAL PROTECTION AND RESTORATION AUTHORITY 450 LAUREL STREET BATON ROUGE, LOUISIANA 70801		OYSTER BAYOU MARSH RESTORATION PROJECT		MARSH CREATION DETAILS	
				C.O.A. FL. #4028 C.O.A. LA. #2531 www.CBI.COM		DRAWN BY: GK		DESIGNED BY: CP		STATE PROJECT NUMBER: CS-59	
								APPROVED BY: WT		DATE: APRIL 13, 2016	
REV.	DATE	DESCRIPTION	BY							SHEET 13 OF 69	

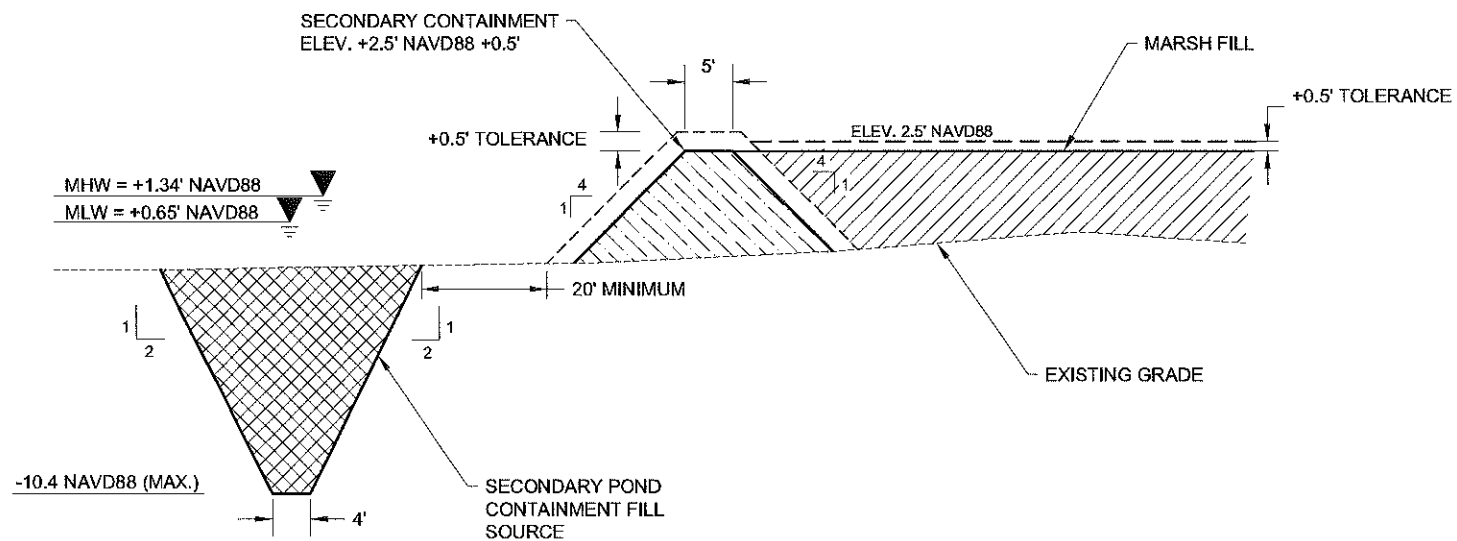

TYPICAL SECONDARY POND CONTAINMENT TYPICAL SECTION
NOT TO SCALE

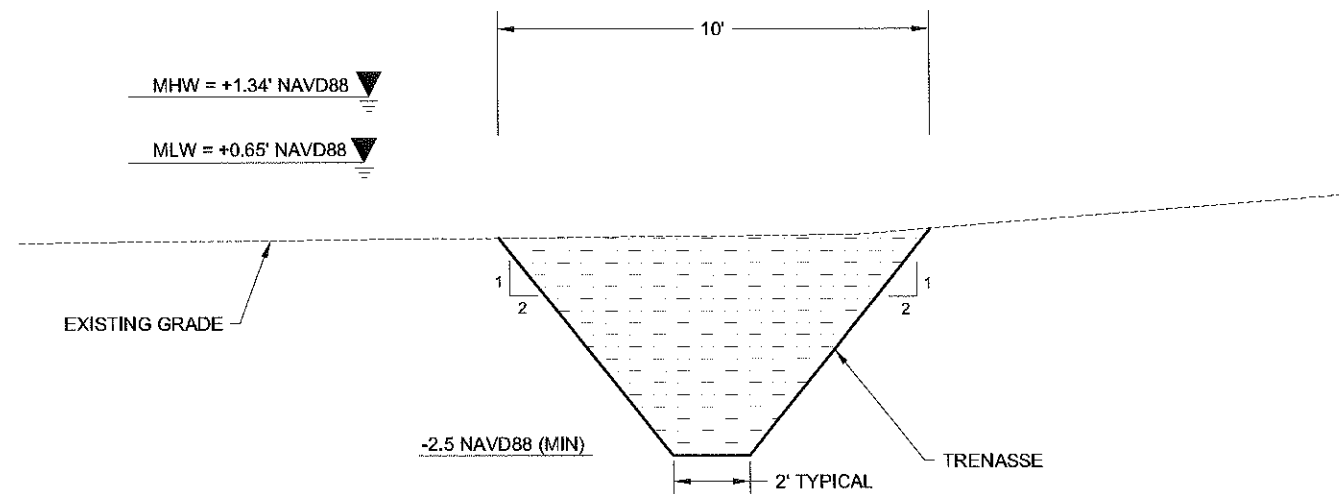

TRENASSE TYPICAL SECTION
NOT TO SCALE

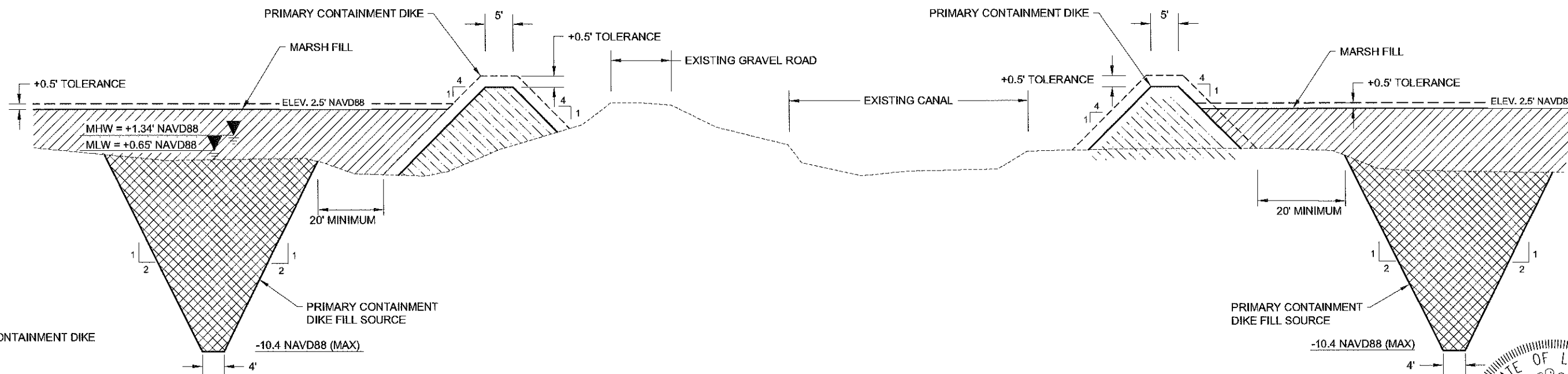

**TYPICAL PRIMARY CONTAINMENT DIKE
NEAR CANAL STA. 80+00**
NOT TO SCALE

LEGEND:

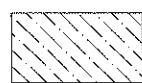
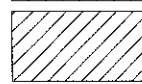
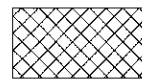
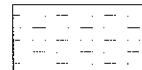
-  CONTAINMENT DIKE
-  MARSH FILL
-  PRIMARY CONTAINMENT DIKE FILL SOURCE
-  TRENASSE

NOTES:

1. ELEVATIONS SHOWN HEREON ARE IN FEET BASED ON NAVD 1988.
2. MATERIAL EXCAVATED FROM THE TRENASSE SHALL BE SPREAD OUT IN ADJACENT MARSH.
3. AT THE TIME OF TRENASSE PAYMENT SURVEYS, NO ADJACENT SPOIL SHALL BE ABOVE ELEVATION +1.5' NAVD88. SEE TS-7 OF THE CONSTRUCTION SPECIFICATIONS.

REV.	DATE	DESCRIPTION	BY

CB&I COASTAL PLANNING & ENGINEERING, INC.
2481 N.W. BOCA RATON BOULEVARD
BOCA RATON, FLORIDA 33431
PH. (561) 391-9102
FAX (561) 391-9116
C.O.A. FL. #4028
C.O.A. LA. #2531
www.CBI.COM

COASTAL PROTECTION AND RESTORATION AUTHORITY
450 LAUREL STREET
BATON ROUGE, LOUISIANA 70801

DRAWN BY: GK

DESIGNED BY: CP

OYSTER BAYOU MARSH RESTORATION PROJECT
STATE PROJECT NUMBER: CS-59
FEDERAL PROJECT NUMBER: CS-59
APPROVED BY: WT

MARSH CREATION DETAILS
DATE: APRIL 13, 2016
SHEET 14 OF 69

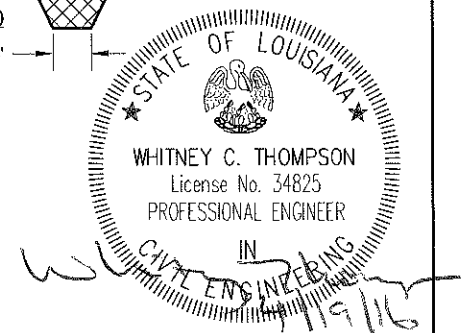

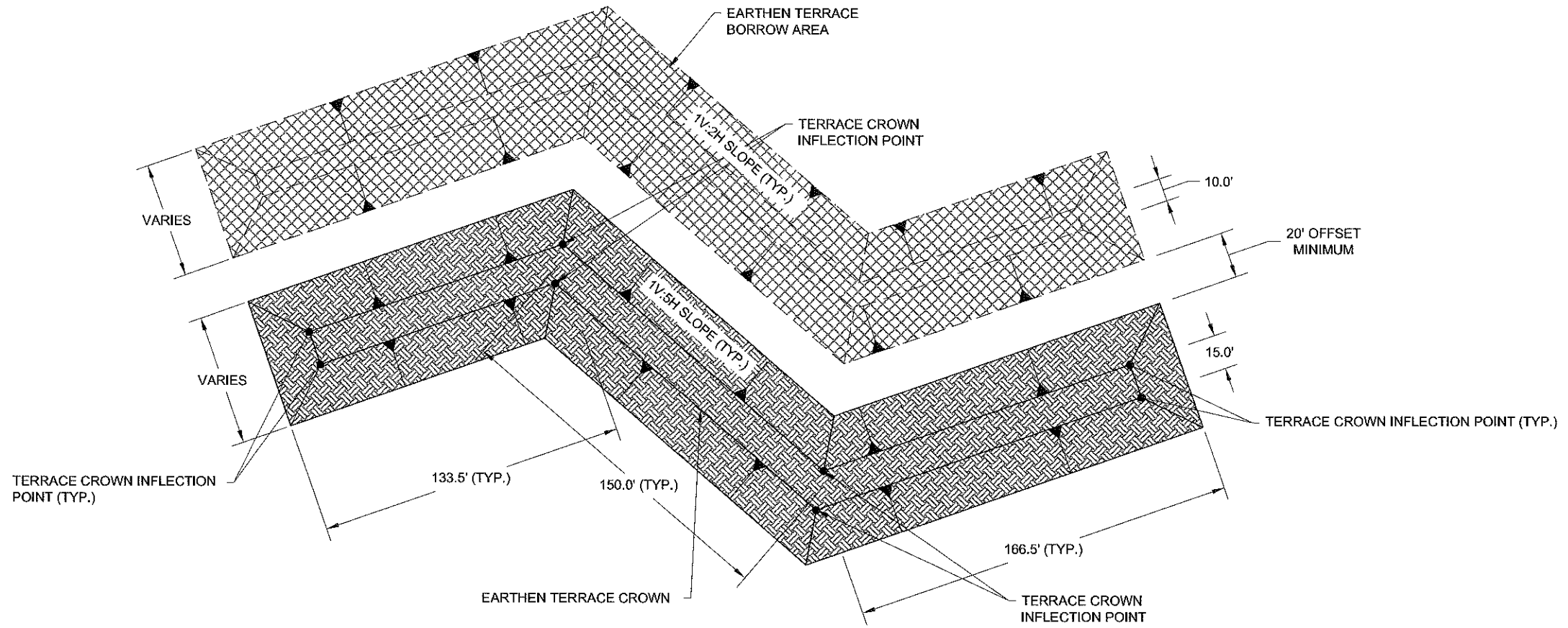

TYPICAL EARTHEN TERRACE DETAIL
PLAN VIEW

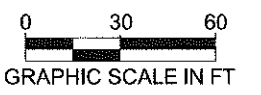
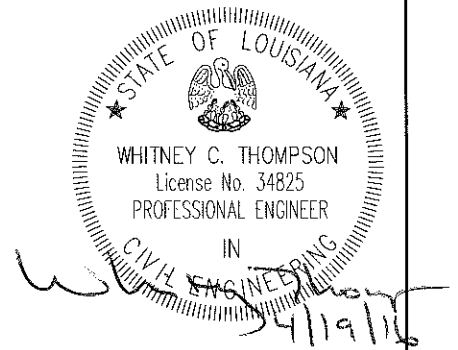

NOTE:
SEE SHEET 4 FOR TERRACE CROWN INFLECTION POINTS.

- LEGEND:**
- EARTHEN TERRACE
 - EARTHEN TERRACE BORROW AREA

REV.	DATE	DESCRIPTION	BY

CB&I COASTAL PLANNING & ENGINEERING, INC.
2481 N.W. BOCA RATON BOULEVARD
BOCA RATON, FLORIDA 33431
PH. (561) 391-8102
FAX (561) 391-9116
C.O.A. FL. #4028
C.O.A. LA. #2531
www.CBI.COM

COASTAL PROTECTION AND RESTORATION AUTHORITY
450 LAUREL STREET
BATON ROUGE, LOUISIANA 70801
DRAWN BY: GK
DESIGNED BY: CP

OYSTER BAYOU MARSH RESTORATION PROJECT
STATE PROJECT NUMBER: CS-59
FEDERAL PROJECT NUMBER: CS-59
APPROVED BY: WT

TYPICAL EARTHEN TERRACE DETAIL
DATE: APRIL 13, 2016
SHEET 15 OF 69

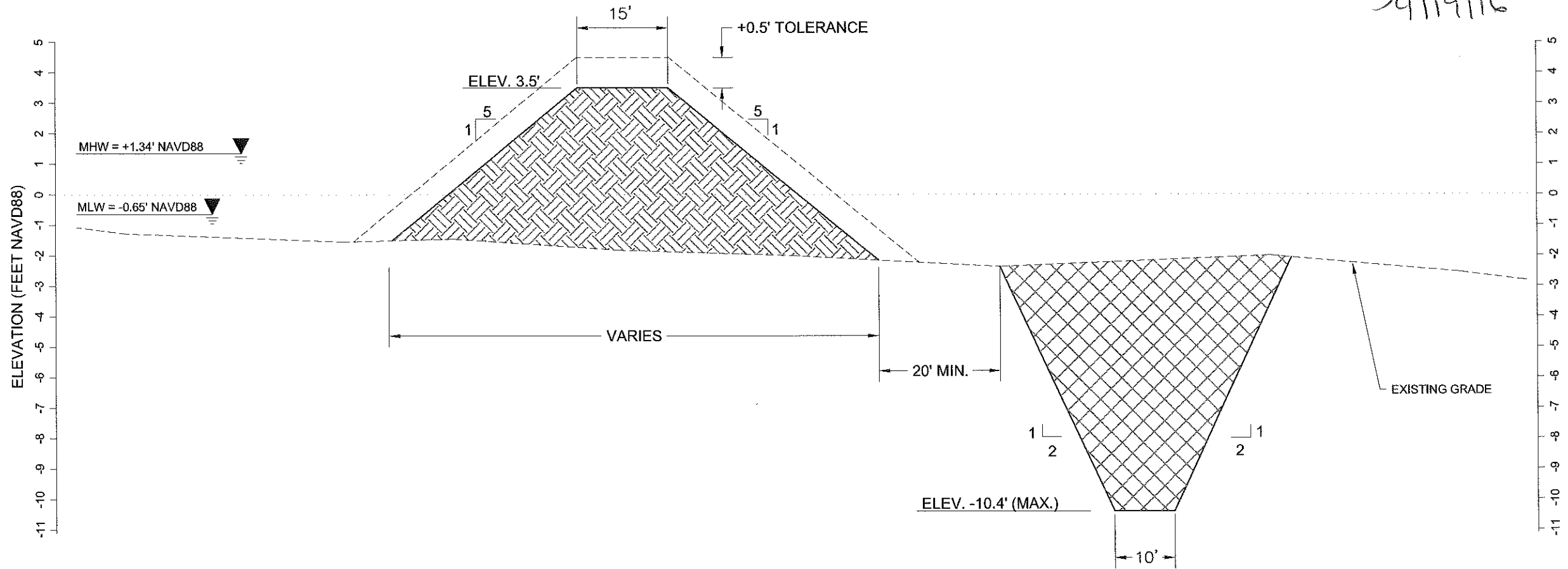
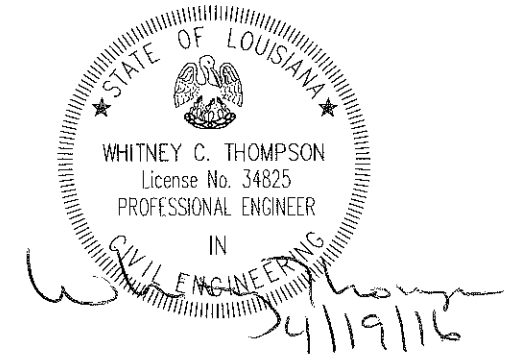

TYPICAL EARTHEN TERRACE CROSS SECTION

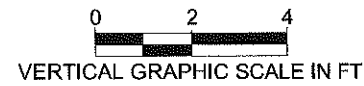
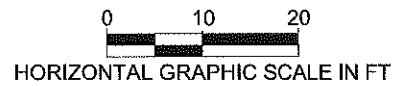

LEGEND:

- EARTHEN TERRACE
- EARTHEN TERRACE BORROW AREA

NOTE:

1. ELEVATIONS SHOWN HEREON ARE IN FEET BASED ON NAVD 1988.

		CB&I COASTAL PLANNING & ENGINEERING, INC. 2481 N.W. BOCA RATON BOULEVARD BOCA RATON, FLORIDA 33431 PH. (561) 391-8102 FAX (561) 391-9116 C.O.A. FL. #4028 C.O.A. LA. #2531 www.CBI.COM	COASTAL PROTECTION AND RESTORATION AUTHORITY 450 LAUREL STREET BATON ROUGE, LOUISIANA 70801	OYSTER BAYOU MARSH RESTORATION PROJECT STATE PROJECT NUMBER: CS-59 FEDERAL PROJECT NUMBER: CS-59	TYPICAL EARTHEN TERRACE CROSS SECTION DATE: APRIL 13, 2016		
REV.	DATE	DESCRIPTION	BY	DRAWN BY: GK	DESIGNED BY: CP	APPROVED BY: WT	SHEET 16 OF 69

LEGEND:

- 19--- BATHYMETRIC CONTOUR
- ◇ GEOENGINEERS 2013 VIBRACORES
- (-28.0') MAXIMUM AFTER DREDGE (AD) ELEVATION
- ⊘ TAR 2013 CULTURAL RESOURCE BUFFERS (NO WORK ZONE)
- ⊕ TAR 2013 MAGNETIC ANOMALIES
- △ CB&I 2013 SIDESCAN SONAR CONTACTS
- ① BORROW AREA COORDINATE LOCATIONS
- - - PIPELINES

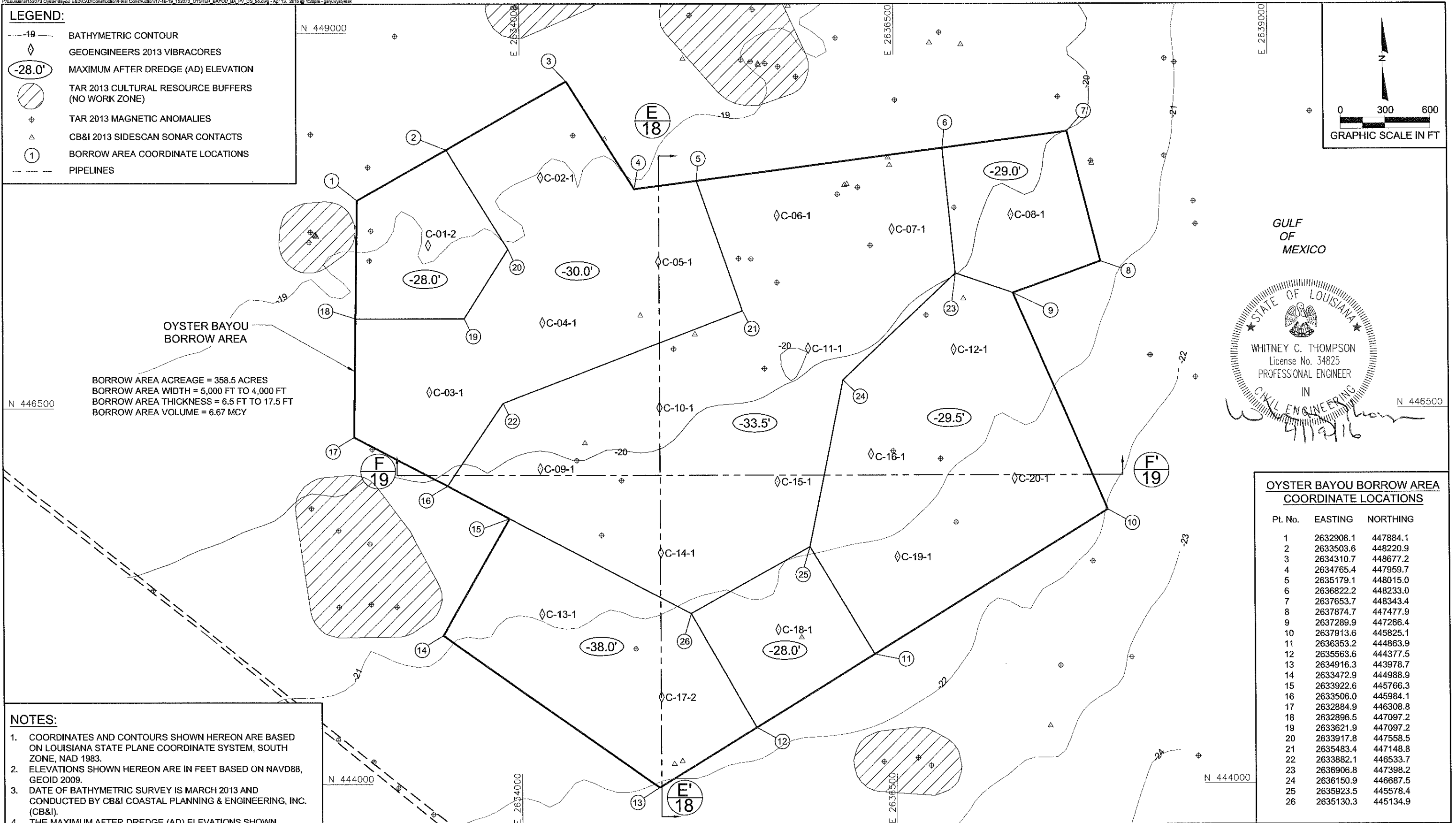

OYSTER BAYOU BORROW AREA
 BORROW AREA ACREAGE = 358.5 ACRES
 BORROW AREA WIDTH = 5,000 FT TO 4,000 FT
 BORROW AREA THICKNESS = 6.5 FT TO 17.5 FT
 BORROW AREA VOLUME = 6.67 MCY

GULF OF MEXICO

N 446500

OYSTER BAYOU BORROW AREA COORDINATE LOCATIONS

Pt. No.	EASTING	NORTHING
1	2632908.1	447884.1
2	2633503.6	448220.9
3	2634310.7	448677.2
4	2634765.4	447959.7
5	2635179.1	448015.0
6	2636822.2	448233.0
7	2637653.7	448343.4
8	2637874.7	447477.9
9	2637289.9	447266.4
10	2637913.6	445825.1
11	2636353.2	444863.9
12	2635563.6	444377.5
13	2634916.3	443978.7
14	2633472.9	444988.9
15	2633922.6	445766.3
16	2633506.0	445984.1
17	2632884.9	446308.8
18	2632896.5	447097.2
19	2633621.9	447097.2
20	2633917.8	447558.5
21	2635483.4	447148.8
22	2633882.1	446533.7
23	2636906.8	447398.2
24	2636150.9	446687.5
25	2635923.5	445578.4
26	2635130.3	445134.9

- NOTES:**
1. COORDINATES AND CONTOURS SHOWN HEREON ARE BASED ON LOUISIANA STATE PLANE COORDINATE SYSTEM, SOUTH ZONE, NAD 1983.
 2. ELEVATIONS SHOWN HEREON ARE IN FEET BASED ON NAVD88, GEOD 2009.
 3. DATE OF BATHYMETRIC SURVEY IS MARCH 2013 AND CONDUCTED BY CB&I COASTAL PLANNING & ENGINEERING, INC. (CB&I).
 4. THE MAXIMUM AFTER DREDGE (AD) ELEVATIONS SHOWN HEREON ARE THE MAXIMUM DEPTHS ALLOWED WITHIN THE BORROW AREA PER THE PERMITS AND BASED ON THE AD SURVEY.
 5. THE CONTRACTOR MAY DISTURB UP TO 3 FEET BENEATH THE MAX AD ELEVATION WITH THEIR EQUIPMENT.

REV.	DATE	DESCRIPTION	BY
	5/28/14	Created Borrow Area Plan and Cross Section Sheets	KM
	9/18/14	Updated Page Numbers/Date	KM
	10/8/14	Updated Page Numbers	KM
	3/27/15	Updated Bathymetry	GK

CB&I COASTAL PLANNING & ENGINEERING, INC.
 2481 N.W. BOCA RATON BOULEVARD
 BOCA RATON, FLORIDA 33431
 PH. (561) 391-6102
 FAX (561) 391-9116
 C.O.A. FL. #4028
 C.O.A. LA. #2531
 www.CBI.COM

COASTAL PROTECTION AND RESTORATION AUTHORITY
 450 LAUREL STREET
 BATON ROUGE, LOUISIANA 70801
 DRAWN BY: GK
 DESIGNED BY: CP

OYSTER BAYOU MARSH RESTORATION PROJECT
 STATE PROJECT NUMBER: CS-59
 FEDERAL PROJECT NUMBER: CS-59
 APPROVED BY: WT

BORROW AREA PLAN VIEW
 DATE: APRIL 13, 2016
 SHEET 17 OF 69

CROSS SECTION E-E' (SEE SHEET 9)

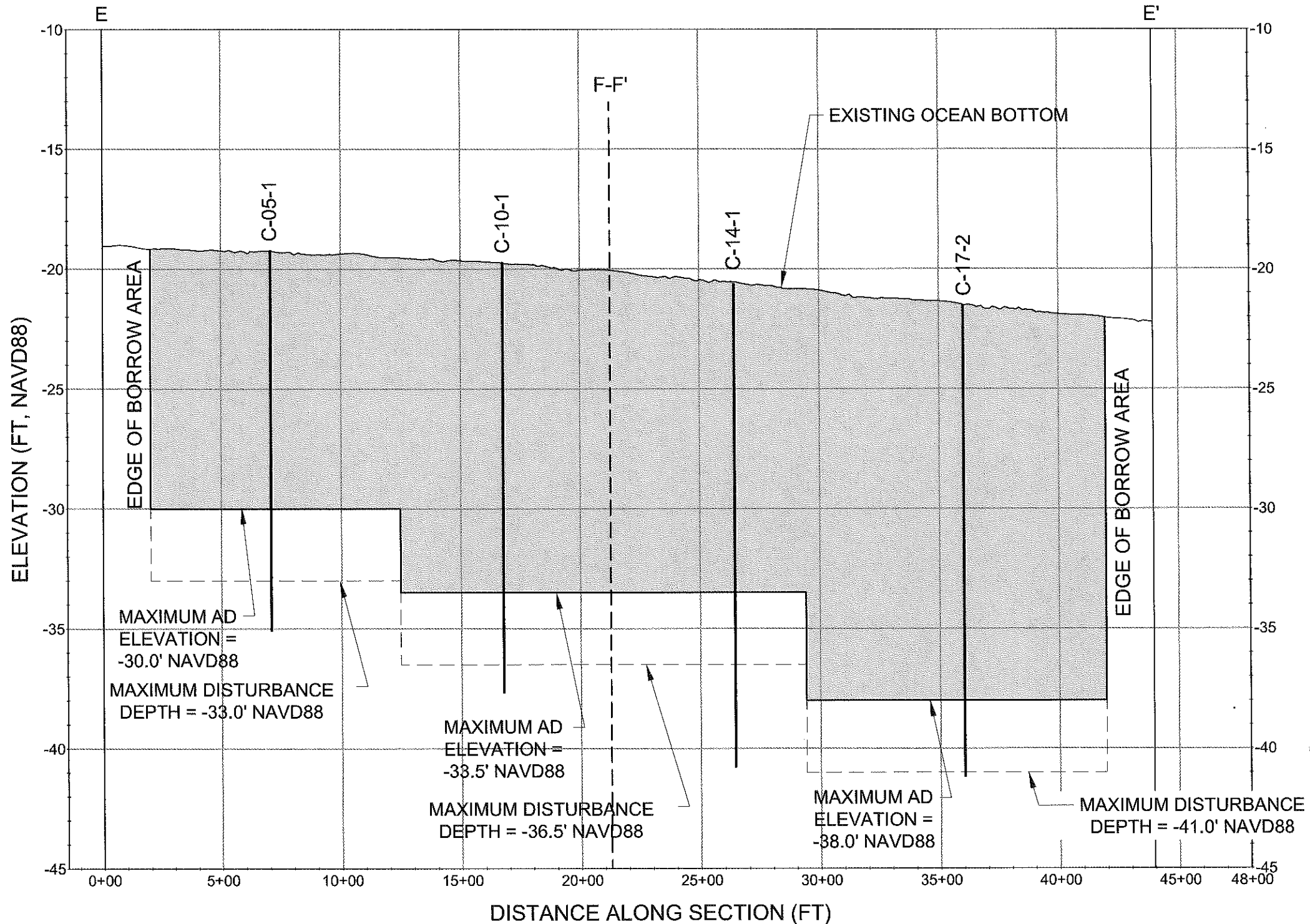

NOTES:

- SEE SHEET 9 FOR LOCATION OF CROSS SECTION LINE.
- ELEVATIONS SHOWN HEREON ARE IN FEET BASED ON NAVD88, GEOID 2009.
- DATE OF BATHYMETRIC SURVEY IS MARCH 2013 AND CONDUCTED BY CB&I COASTAL PLANNING & ENGINEERING, INC. (CB&I).
- THE MAXIMUM AFTER DREDGE (AD) ELEVATIONS SHOWN HEREON ARE THE MAXIMUM DEPTHS ALLOWED WITHIN THE BORROW AREA PER THE PERMITS AND BASED ON THE AD SURVEY.
- THE CONTRACTOR MAY DISTURB UP TO 3 FEET BENEATH THE MAX AD ELEVATION WITH THEIR EQUIPMENT.
- CORES MAY NOT FALL DIRECTLY ON CROSS SECTION LINE, BUT ARE LOCATED SUFFICIENTLY CLOSE TO REPRESENT SIMILAR MATERIAL.
- WIDTH OF LAYERS IS REPRESENTATIVE ONLY. ACTUAL MATERIAL MAY VARY.

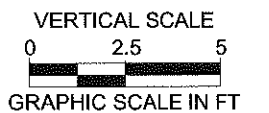
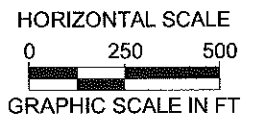

REV.	DATE	DESCRIPTION	BY
	5/28/14	Created Borrow Area Plan and Cross Section Sheets	KM
	9/18/14	Updated Page Numbers/Date	KM
	10/8/14	Updated Page Numbers	KM
	3/27/15	Updated Section per updated bathymetry	GK

CB&I COASTAL PLANNING & ENGINEERING, INC.
 2481 N.W. BOCA RATON BOULEVARD
 BOCA RATON, FLORIDA 33431
 PH. (561) 391-8102
 FAX (561) 391-9116
 C.O.A. FL. #4028
 C.O.A. LA. #2531
 www.CBI.COM

COASTAL PROTECTION AND RESTORATION AUTHORITY
 450 LAUREL STREET
 BATON ROUGE, LOUISIANA 70801
 DRAWN BY: GK
 DESIGNED BY: CP

OYSTER BAYOU MARSH RESTORATION PROJECT
 STATE PROJECT NUMBER: CS-59
 FEDERAL PROJECT NUMBER: CS-59
 APPROVED BY: WT

BORROW AREA CROSS SECTION E-E'
 DATE: APRIL 13, 2016
 SHEET 18 OF 69

CROSS SECTION F-F' (SEE SHEET 9)

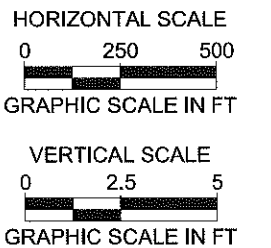
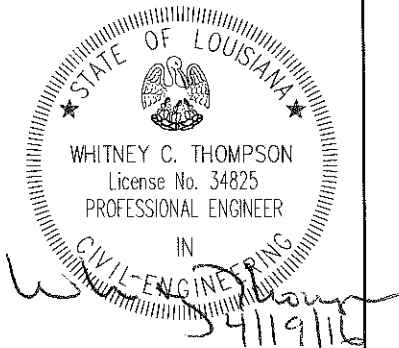
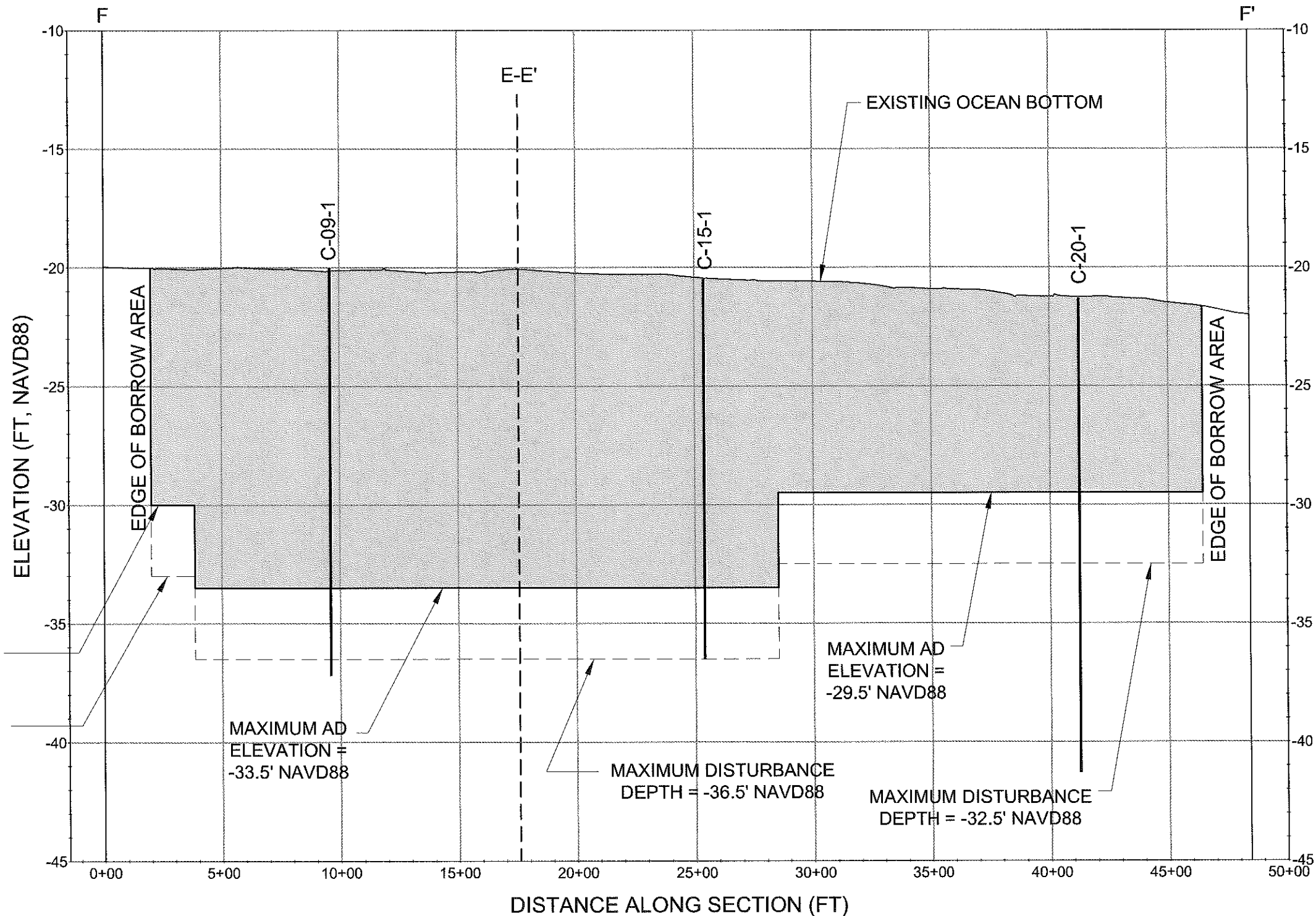

NOTES:

1. SEE SHEET 9 FOR LOCATION OF CROSS SECTION LINE.
2. ELEVATIONS SHOWN HEREON ARE IN FEET BASED ON NAVD88, GEOID 2009.
3. DATE OF BATHYMETRIC SURVEY IS MARCH 2013 AND CONDUCTED BY CB&I COASTAL PLANNING & ENGINEERING, INC. (CB&I).
4. THE MAXIMUM AFTER DREDGE (AD) ELEVATIONS SHOWN HEREON ARE THE MAXIMUM DEPTHS ALLOWED WITHIN THE BORROW AREA PER THE PERMITS AND BASED ON THE AD SURVEY.
5. THE CONTRACTOR MAY DISTURB UP TO 3 FEET BENEATH THE MAX AD ELEVATION WITH THEIR EQUIPMENT.
6. CORES MAY NOT FALL DIRECTLY ON CROSS SECTION LINE, BUT ARE LOCATED SUFFICIENTLY CLOSE TO REPRESENT SIMILAR MATERIAL.
7. WIDTH OF LAYERS IS REPRESENTATIVE ONLY. ACTUAL MATERIAL MAY VARY.

REV.	DATE	DESCRIPTION	BY
	5/28/14	Created Borrow Area Plan and Cross Section Sheets	KM
	9/18/14	Updated Page Numbers/Date	KM
	10/8/14	Updated Page Numbers	KM
	3/27/15	Updated Section per updated bathymetry	GK

CB&I COASTAL PLANNING & ENGINEERING, INC.
 2481 N.W. BOCA RATON BOULEVARD
 BOCA RATON, FLORIDA 33431
 PH. (561) 391-8102
 FAX (561) 391-9116
 C.O.A. FL. #4028
 C.O.A. LA. #2531
 www.CBI.COM

COASTAL PROTECTION AND RESTORATION AUTHORITY
 450 LAUREL STREET
 BATON ROUGE, LOUISIANA 70801
 DRAWN BY: GK
 DESIGNED BY: CP

OYSTER BAYOU MARSH RESTORATION PROJECT
 STATE PROJECT NUMBER: CS-59
 FEDERAL PROJECT NUMBER: CS-59
 APPROVED BY: WT

BORROW AREA CROSS SECTION F-F'
 DATE: APRIL 13, 2016
 SHEET 19 OF 69

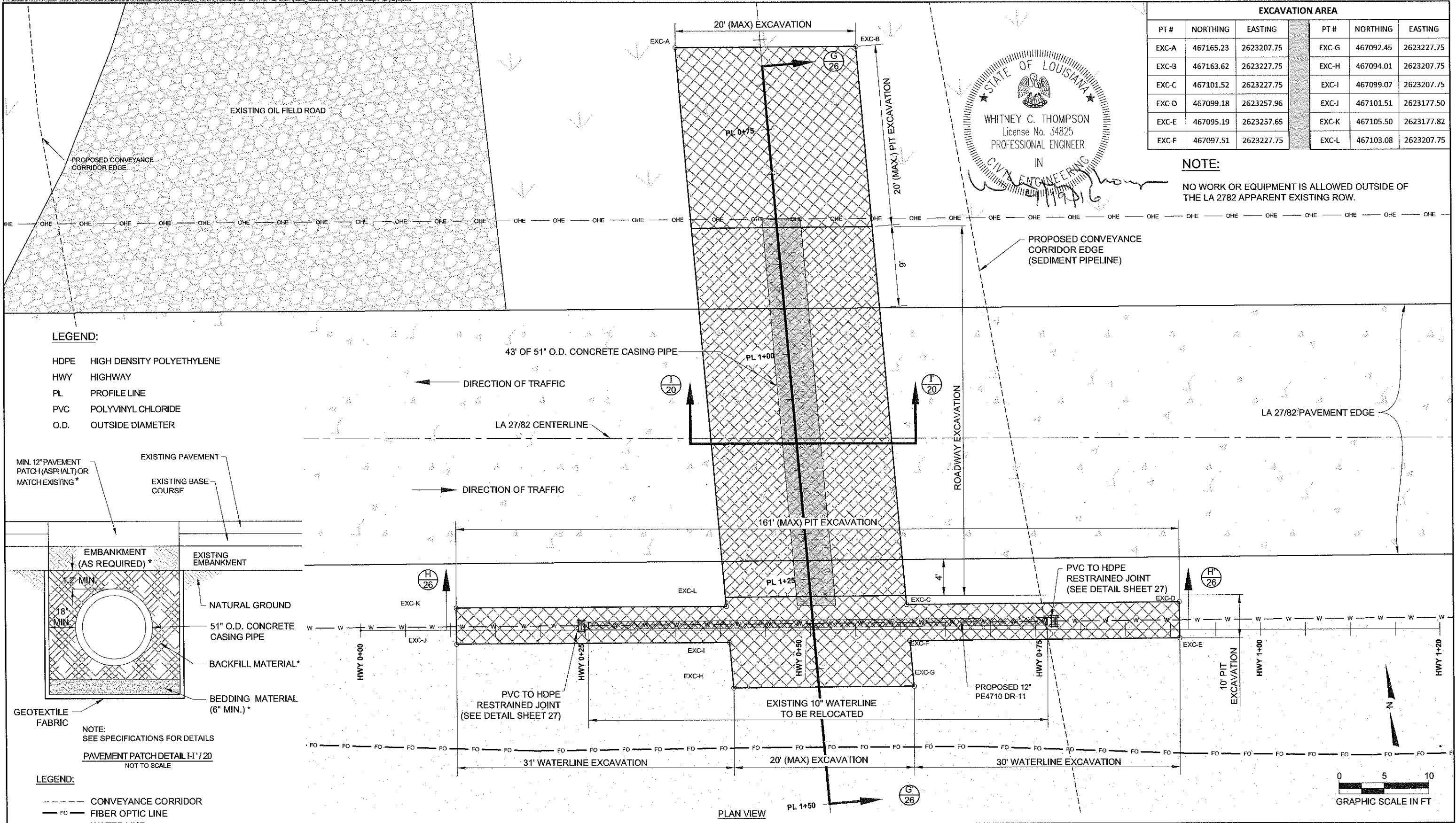

EXCAVATION AREA					
PT #	NORTHING	EASTING	PT #	NORTHING	EASTING
EXC-A	467165.23	2623207.75	EXC-G	467092.45	2623227.75
EXC-B	467163.62	2623227.75	EXC-H	467094.01	2623207.75
EXC-C	467101.52	2623227.75	EXC-I	467099.07	2623207.75
EXC-D	467099.18	2623257.96	EXC-J	467101.51	2623177.50
EXC-E	467095.19	2623257.65	EXC-K	467105.50	2623177.82
EXC-F	467097.51	2623227.75	EXC-L	467103.08	2623207.75

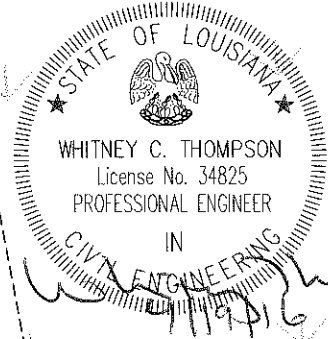

NOTE:
NO WORK OR EQUIPMENT IS ALLOWED OUTSIDE OF THE LA 2782 APPARENT EXISTING ROW.

- LEGEND:**
- HDPE HIGH DENSITY POLYETHYLENE
 - HWY HIGHWAY
 - PL PROFILE LINE
 - PVC POLYVINYL CHLORIDE
 - O.D. OUTSIDE DIAMETER

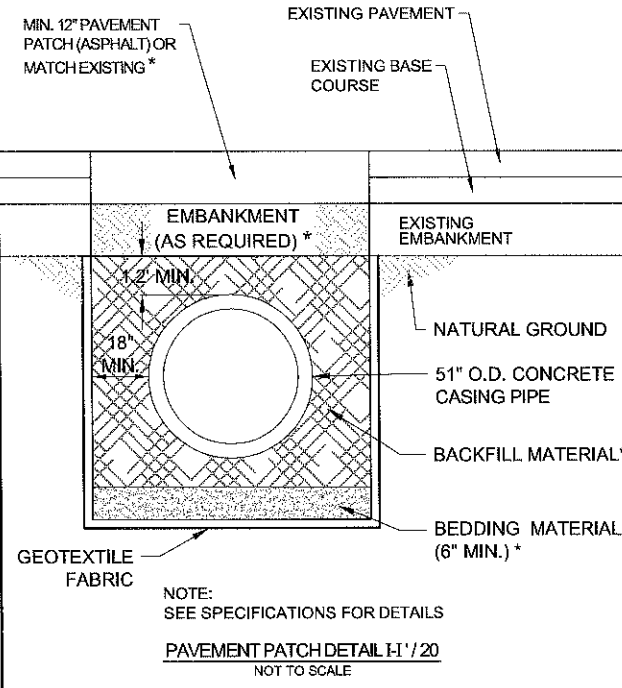

- LEGEND:**
- CONVEYANCE CORRIDOR
 - FO FIBER OPTIC LINE
 - W WATER LINE
 - OHE OVERHEAD ELECTRIC LINE
 - ROADWAY EXCAVATION
 - ACCESS PIT EXCAVATION
 - EXISTING HIGHWAY
 - SAND
 - GRAVEL ROAD
 - MARSH

REV.	DATE	DESCRIPTION	BY

CB&I COASTAL PLANNING & ENGINEERING, INC.
2481 N.W. BOCA RATON BOULEVARD
BOCA RATON, FLORIDA 33431
PH (561) 391-8102
FAX (561) 391-9116
C.O.A. FL. #4028
C.O.A. LA. #2531
www.CBI.COM

COASTAL PROTECTION AND RESTORATION AUTHORITY
450 LAUREL STREET
BATON ROUGE, LOUISIANA 70801
DRAWN BY: GK
DESIGNED BY: CP

OYSTER BAYOU MARSH RESTORATION PROJECT
STATE PROJECT NUMBER: CS-59
FEDERAL PROJECT NUMBER: CS-59
APPROVED BY: WT

LA 27/82 CROSSING PLAN VIEW AND PAVEMENT PATCH DETAIL
DATE: APRIL 13, 2016
SHEET 20 OF 69

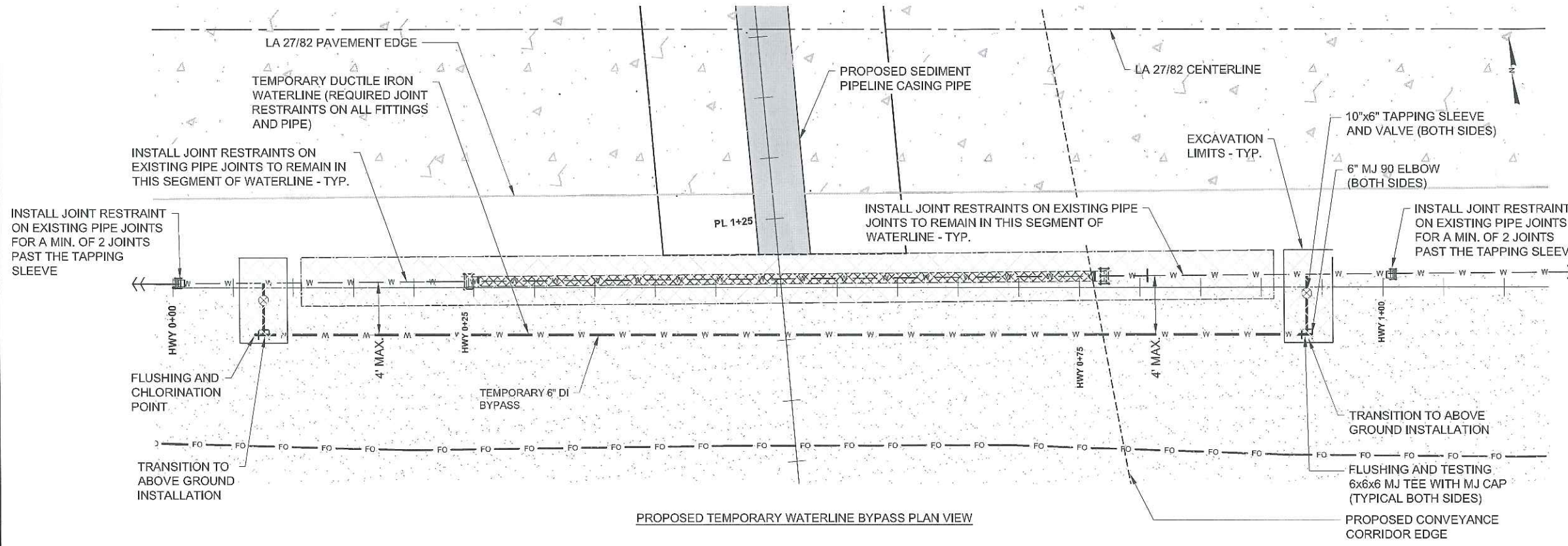

SEQUENCE OF TEMPORARY WATERLINE BYPASS INSTALLATION:
(SEE TS-11 FOR ADDITIONAL DETAILS)

1. PRIOR TO ANY EXCAVATION ACTIVITY, THE CONTRACTOR SHALL COORDINATE WITH THE FIBER OPTIC COMPANY AND LOCATE THE FIBER OPTIC LINE. AT ALL TIMES, THE CONTRACTOR SHALL MAINTAIN A 5 FOOT BUFFER AROUND THE FIBER OPTIC LINE.
2. INSTALL TAPPING SLEEVES AND VALVES, MAKE 6" TAPS AND CLOSE VALVES. INSTALL JOINT RESTRAINTS, FLUSHING AND TESTING RISERS, CHLORINATION POINTS, AND 6" DUCTILE IRON PIPE AND FITTINGS.
3. THEN FLUSH, PRESSURE TEST AND CHLORINATE 6" DUCTILE IRON PIPE.
4. PLACE 6" BYPASS LINE IN SERVICE (AFTER DHH LABORATORY APPROVAL OF BYPASS LINE SAMPLE).
5. AFTER STEPS 1-4 ARE COMPLETED, WATER FLOWS THROUGH BOTH PIPELINES - PROCEED TO PERMANENT WATERLINE INSTALLATION.
6. ONLY WATER DISTRICT PERSONNEL SHALL OPERATE THE VALVES INSTALLED UNDER THIS PROJECT TO PLACE THE NEW WATER LINE IN SERVICE.
7. CONTRACTOR SHALL INSTALL SAND BAGS (OR OTHER APPROVED MEANS) OVER THE NEW WATERLINE TO PREVENT HORIZONTAL/VERTICAL MOVEMENT WHILE IT IS IN SERVICE.

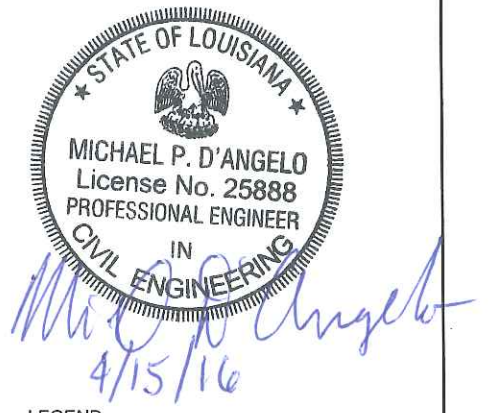
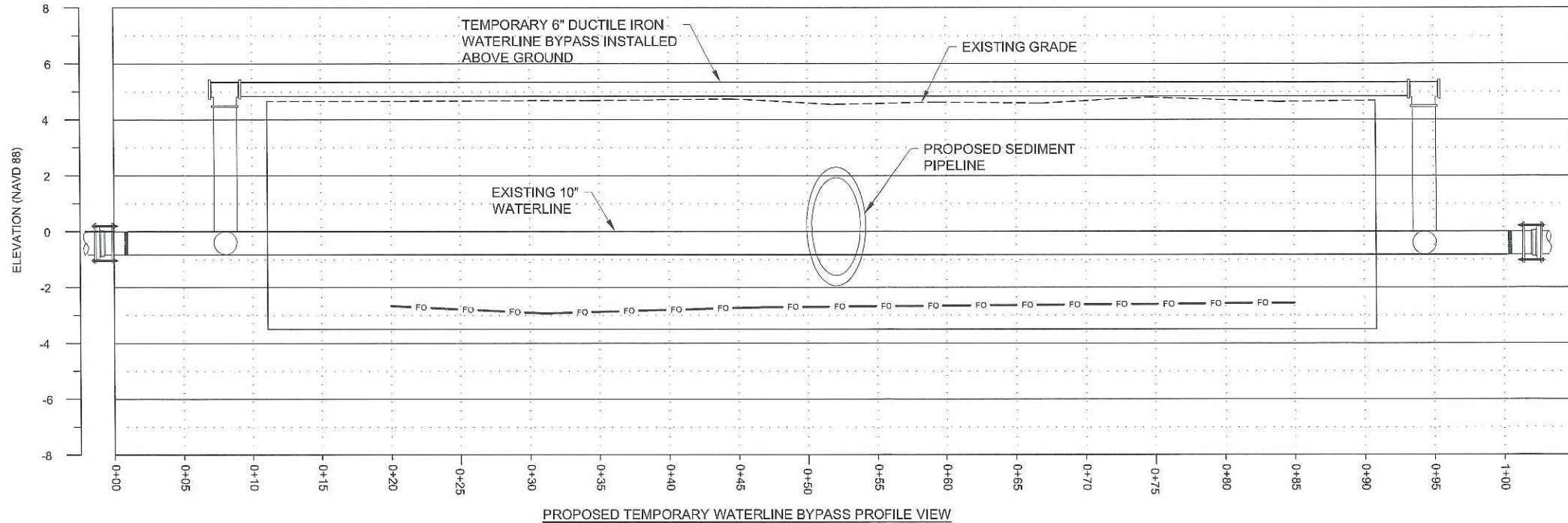

LEGEND:

	CONVEYANCE CORRIDOR
	FIBER OPTIC LINE
	WATER LINE
	EXISTING HIGHWAY
	EXISTING SAND

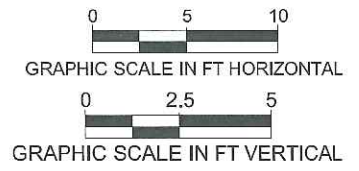

REV.	DATE	DESCRIPTION	BY

CB&I COASTAL PLANNING & ENGINEERING, INC.
2481 N.W. BOCA RATON BOULEVARD
BOCA RATON, FLORIDA 33431
PH. (561) 391-8102
FAX (561) 391-9116
C.O.A. FL. #4028
C.O.A. LA. #2531
www.CBI.COM

COASTAL PROTECTION AND RESTORATION AUTHORITY
450 LAUREL STREET
BATON ROUGE, LOUISIANA 70801
DRAWN BY: GK
DESIGNED BY: CP

OYSTER BAYOU MARSH RESTORATION PROJECT
STATE PROJECT NUMBER: CS-59
FEDERAL PROJECT NUMBER: CS-59
APPROVED BY: WT

LA 27/82 TEMPORARY WATERLINE BYPASS PLAN AND DETAIL
DATE: APRIL 13, 2016
SHEET 21 OF 69

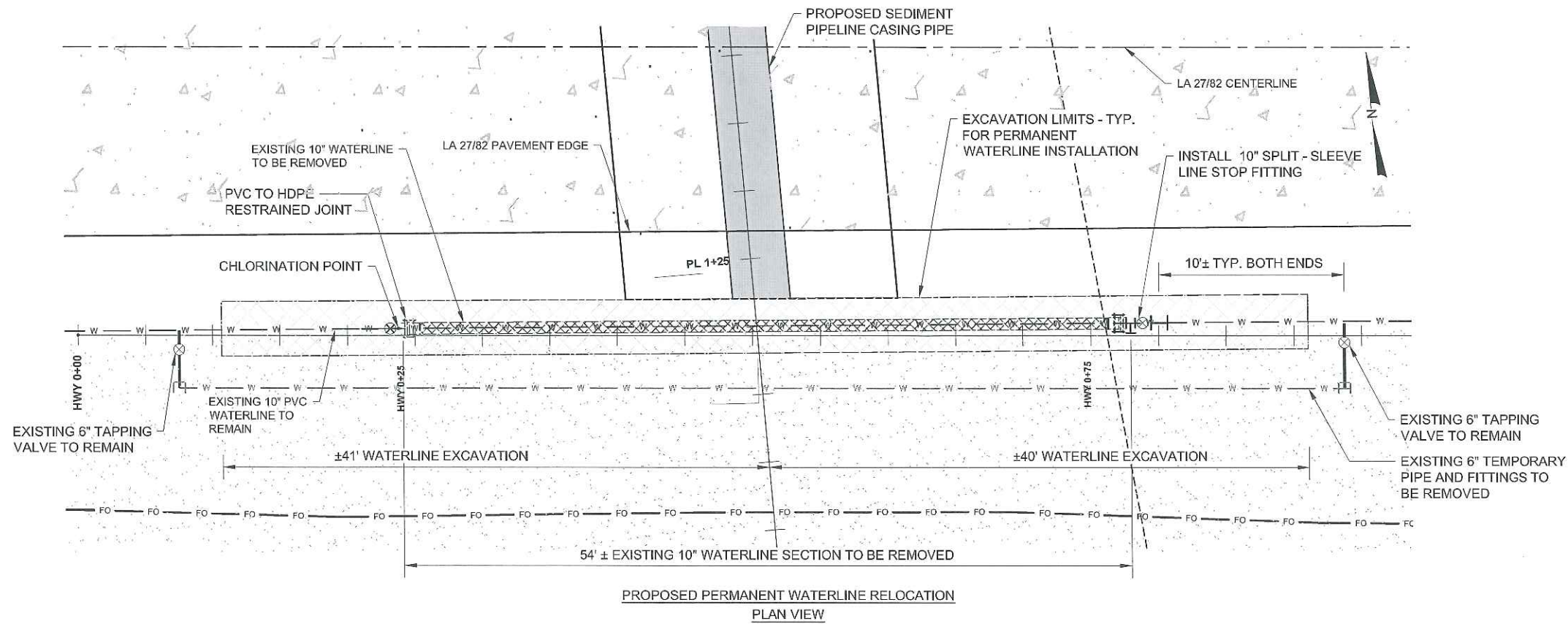

SEQUENCE OF PERMANENT WATERLINE RELOCATION:
(SEE TS-11 FOR ADDITIONAL DETAILS)

1. PRIOR TO ANY EXCAVATION ACTIVITY, THE CONTRACTOR SHALL COORDINATE WITH THE FIBER OPTIC COMPANY AND LOCATE THE FIBER OPTIC LINE. AT ALL TIMES, THE CONTRACTOR SHALL MAINTAIN A 5 FOOT BUFFER AROUND THE FIBER OPTIC LINE.
2. INSTALL PROPOSED SPLIT-SLEEVE LINE STOP FITTINGS AS SHOWN AND PLUG EXISTING 10" PVC WATERLINE AT BOTH LOCATIONS USING THE LINE STOP FITTINGS SO THAT FLOW THROUGH THE SEGMENT OF EXISTING 10" PVC WATERLINE IS STOPPED.
3. REMOVE SEGMENT OF EXISTING 10" PVC WATERLINE BETWEEN THE PLUGS, AND INSTALL PROPOSED 12" PE PERMANENT WATERLINE AND ASSOCIATED FITTINGS AND APPURTENANCES SHOWN.
4. FLUSH, PRESSURE TEST, AND CHLORINATE 12" PE WATERLINE WHILE MAINTAINING ONE OPEN END WITH OTHER END CONNECTED TO EXISTING 10" PVC WATERLINE. INSTALL TEMPORARY CAP ON 12" PE WATERLINE TO PERFORM PRESSURE TEST, AND REMOVE ONE OF THE TWO PLUGS TO FACILITATE FLUSHING AND PRESSURE TEST.
5. SUBMIT SAMPLE FROM 12" PE WATERLINE TO EXISTING LABORATORY FOR APPROVAL.
6. UPON DHH APPROVAL OF SAMPLE, CONNECT OPEN END OF 12" PE WATERLINE TO EXISTING 10" PVC WATERLINE AND REMOVE REMAINING PLUG TO PLACE 12" PE WATERLINE INTO SERVICE.
7. REMOVE 6" TEMPORARY WATERLINE BYPASS AND FITTINGS, ETC. EXCEPT FOR TAPPING SLEEVE AND VALVES.

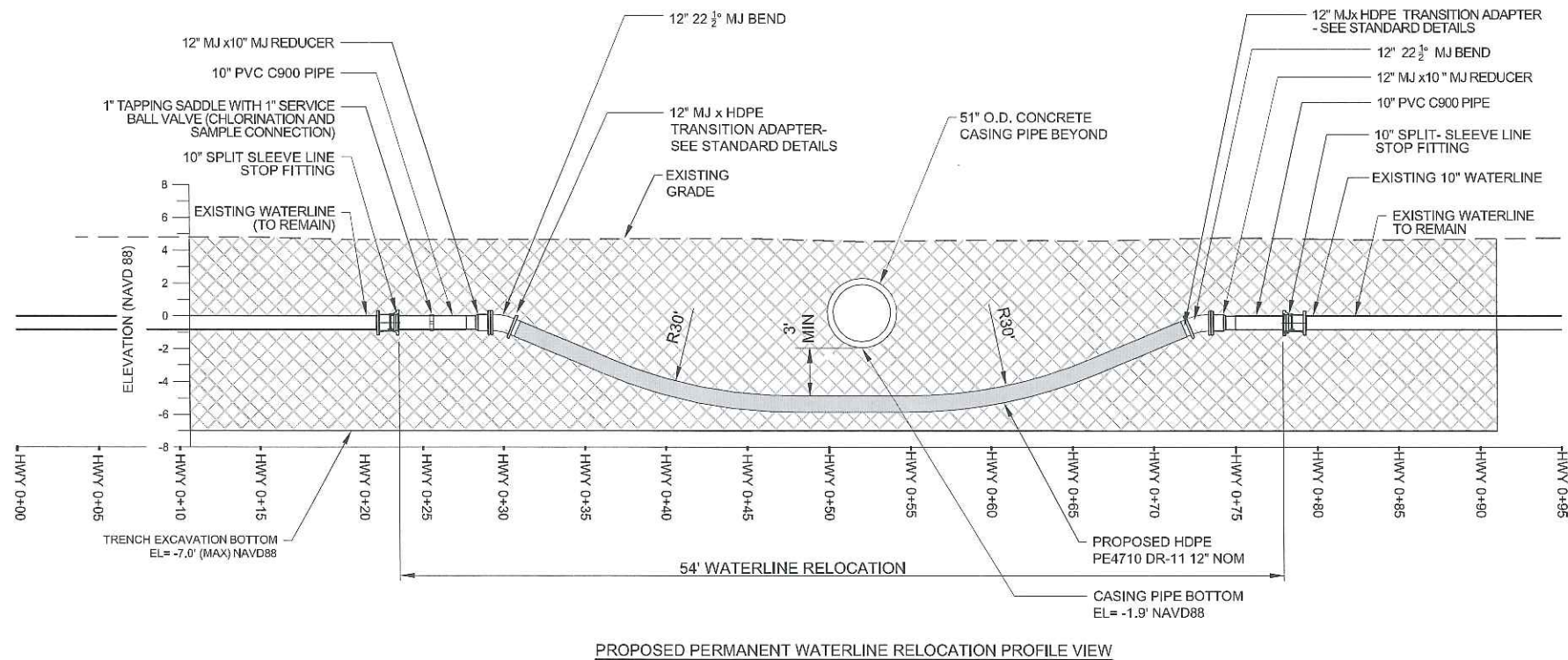

LEGEND:

DIP	DUCTILE IRON PIPE
HDPE	HIGH DENSITY POLYETHYLENE
PVC	POLYVINYL CHLORIDE
HWY	HIGHWAY
NAVD	NORTH AMERICAN VERTICAL DATUM
I.D.	INSIDE DIAMETER
O.D.	OUTSIDE DIAMETER
EL	ELEVATION
MJ	MECHANICAL JOINT
NOM	NOMINAL
TYP	TYPICAL
---	CONVEYANCE CORRIDOR
FO	FIBER OPTIC LINE
W	WATER LINE
---	EXISTING HIGHWAY
○	CHLORINATION POINT
▨	EXISTING SAND

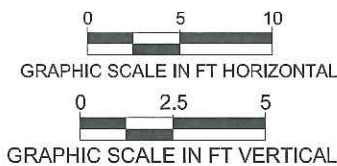

REV.	DATE	DESCRIPTION	BY

CB&I COASTAL PLANNING & ENGINEERING, INC.
2481 N.W. BOCA RATON BOULEVARD
BOCA RATON, FLORIDA 33431
PH. (561) 391-8102
FAX (561) 391-8116
C.O.A. FL. #4028
C.O.A. LA. #2531
www.CBI.COM

COASTAL PROTECTION AND RESTORATION AUTHORITY
450 LAUREL STREET
BATON ROUGE, LOUISIANA 70801
DRAWN BY: GK
DESIGNED BY: CP

OYSTER BAYOU MARSH RESTORATION PROJECT
STATE PROJECT NUMBER: CS-59
FEDERAL PROJECT NUMBER: CS-59
APPROVED BY: WT

LA 27/82 PERMANENT WATERLINE RELOCATION PLAN AND DETAIL
DATE: APRIL 13, 2016
SHEET 22 OF 69

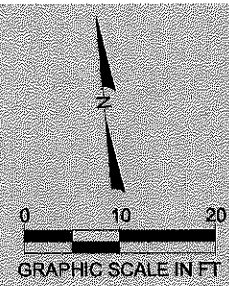
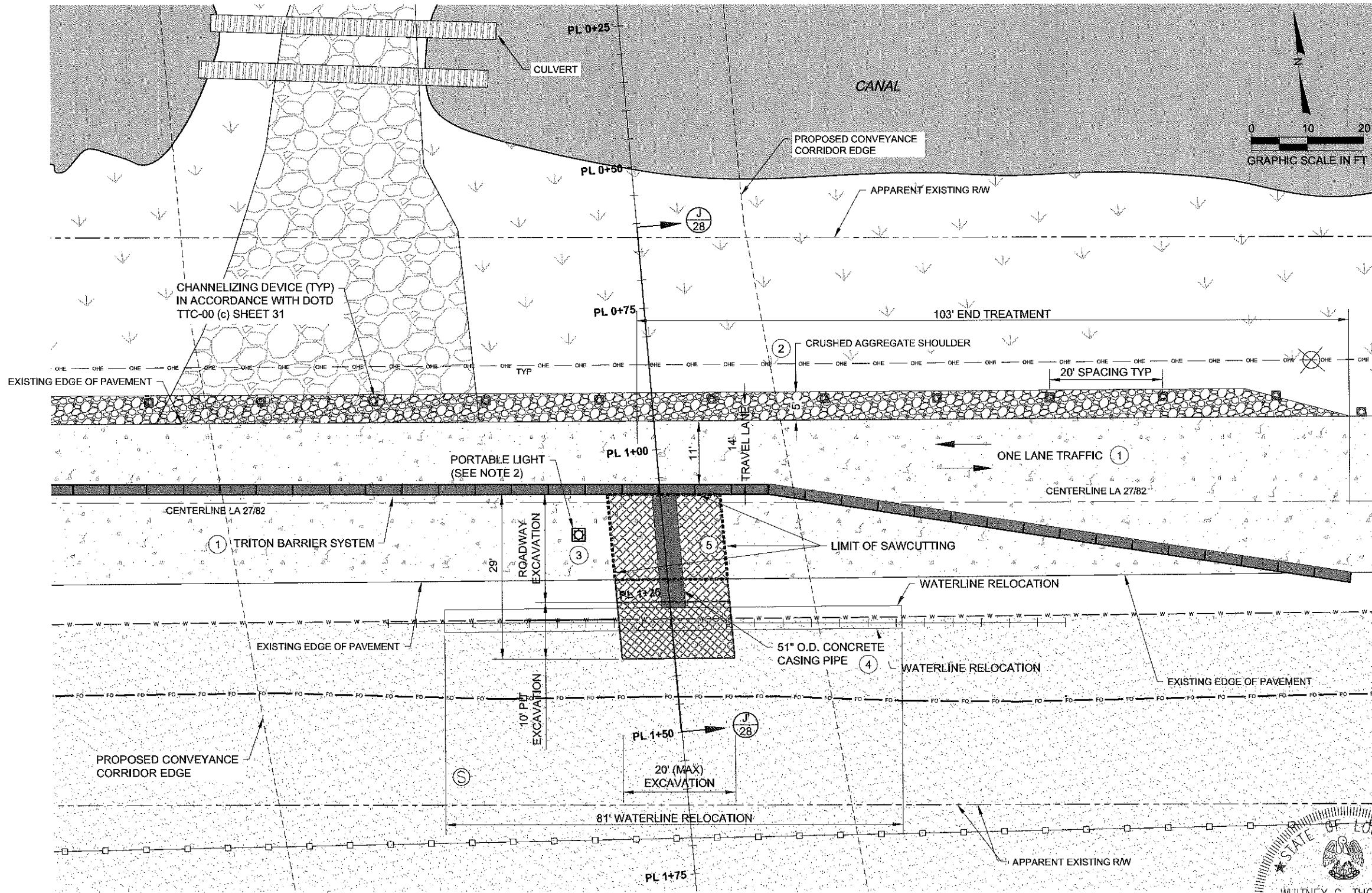

PHASE 1 (CASING PIPE INSTALLATION):

- ① PLACEMENT OF TEMPORARY TRAFFIC CONTROL DEVICES SHALL BE IN ACCORDANCE WITH DOTD TTC-04 PLAN SHEET 35 AND INCLUDE:
 - TRITON BARRIERS
 - FLAGGERS
 - TEMPORARY SIGNAGE
 - PORTABLE LIGHT PLANTS
- ② PLACEMENT OF 5' OF CRUSHED AGGREGATE AND GEOTEXTILE FABRIC ON THE WESTBOUND SHOULDER
- ③ BRACED TRENCH EXCAVATION MAINTAINING A 12' (MIN) TRAVEL LANE WIDTH
- ④ PLACEMENT OF CASING PIPE
- ⑤ BACKFILL EXCAVATED TRENCH AND PLACE ASPHALT PAVEMENT PATCHING. SEE "PAVEMENT PATCH DETAIL" ON SHEET 20 OF CONSTRUCTION DRAWINGS. SEE TS-12 OF THE SPECIFICATIONS FOR PAVEMENT PATCH DETAILS.

NOTES:

1. ALL TEMPORARY TRAFFIC CONTROL (TTC) DEVICES SHALL BE USED IN ACCORDANCE WITH THE "LOUISIANA STANDARD SPECIFICATIONS FOR ROADS AND BRIDGES", 2006 EDITION, AND THE MUTCD, 2009 EDITION, AND SHALL MEET THE NCHRP REPORT 350 OR MASH REQUIREMENTS FOR TEST LEVEL 3 DEVICES. (SEE SHEETS 30-35)
2. DURING PHASE 1 OF PERMANENT CASING PIPE INSTALLATION, FLAGGERS SHALL BE USED (24/7). PORTABLE LIGHT PLANTS SHALL BE INSTALLED AT EACH FLAGGER STATION, AND IF NIGHT OPERATIONS ARE CONDUCTED, PORTABLE LIGHT PLANT SHALL BE USED AT THE WORK SITE.
3. ALL NIGHTTIME OPERATIONS SHALL BE CONDUCTED IN ACCORDANCE WITH SECTION 105.20 OF "LOUISIANA STANDARD SPECIFICATIONS FOR ROADS AND BRIDGES", 2006 EDITION.
4. SEE SECTION J-J' ON SHEET 28 FOR PHASE 1 CROSS SECTION VIEW.
5. SEE TS-12 FOR TRAFFIC MAINTENANCE REQUIREMENTS.

LEGEND (ABBREVIATIONS):

DOTD	DEPARTMENT OF TRANSPORTATION AND DEVELOPMENT (LOUISIANA)
MUTCD	MANUAL ON UNIFORM TRAFFIC CONTROL DEVICES
NCHRP	NATIONAL COOPERATIVE HIGHWAY RESEARCH PROGRAM
R/W	RIGHT OF WAY
O.D.	OUTSIDE DIAMETER
TTC	TEMPORARY TRAFFIC CONTROL
TYP	TYPICAL
24/7	24 HOURS, 7 DAYS

SEQUENCE LEGEND:

	ROADWAY EXCAVATION
	ACCESS EXCAVATION
	CRUSHED AGGREGATE
	LIMIT OF SAWCUTTING
	PORTABLE LIGHT PLANT
	CHANNELIZING DEVICE

LEGEND:

	CONVEYANCE CORRIDOR
	FENCELINE
	RIGHT OF WAY LINE
	OVERHEAD ELECTRIC LINE
	WATERLINE
	FIBER OPTIC LINE
	SANITARY SEWER MANHOLE
	POWER POLE
	EXISTING HIGHWAY
	SAND
	GRAVEL ROAD
	MARSH

PLAN VIEW

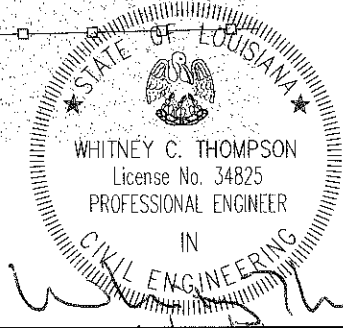

		CB&I COASTAL PLANNING & ENGINEERING, INC. 2481 N.W. BOCA RATON BOULEVARD BOCA RATON, FLORIDA 33431 PH. (561) 391-8102 FAX (561) 391-9116 C.O.A. FL. #4028 C.O.A. LA. #2531 www.CBI.COM	COASTAL PROTECTION AND RESTORATION AUTHORITY 450 LAUREL STREET BATON ROUGE, LOUISIANA 70801	OYSTER BAYOU MARSH RESTORATION PROJECT STATE PROJECT NUMBER: CS-59 FEDERAL PROJECT NUMBER: CS-59 APPROVED BY: WT	LA 27/82 PHASE 1 PLAN VIEW CASING PIPE INSTALLATION SEQUENCE OF CONSTRUCTION DATE: APRIL 13, 2016 SHEET 23 OF 69
REV.	DATE	DESCRIPTION	BY	DRAWN BY: GK	DESIGNED BY: CP

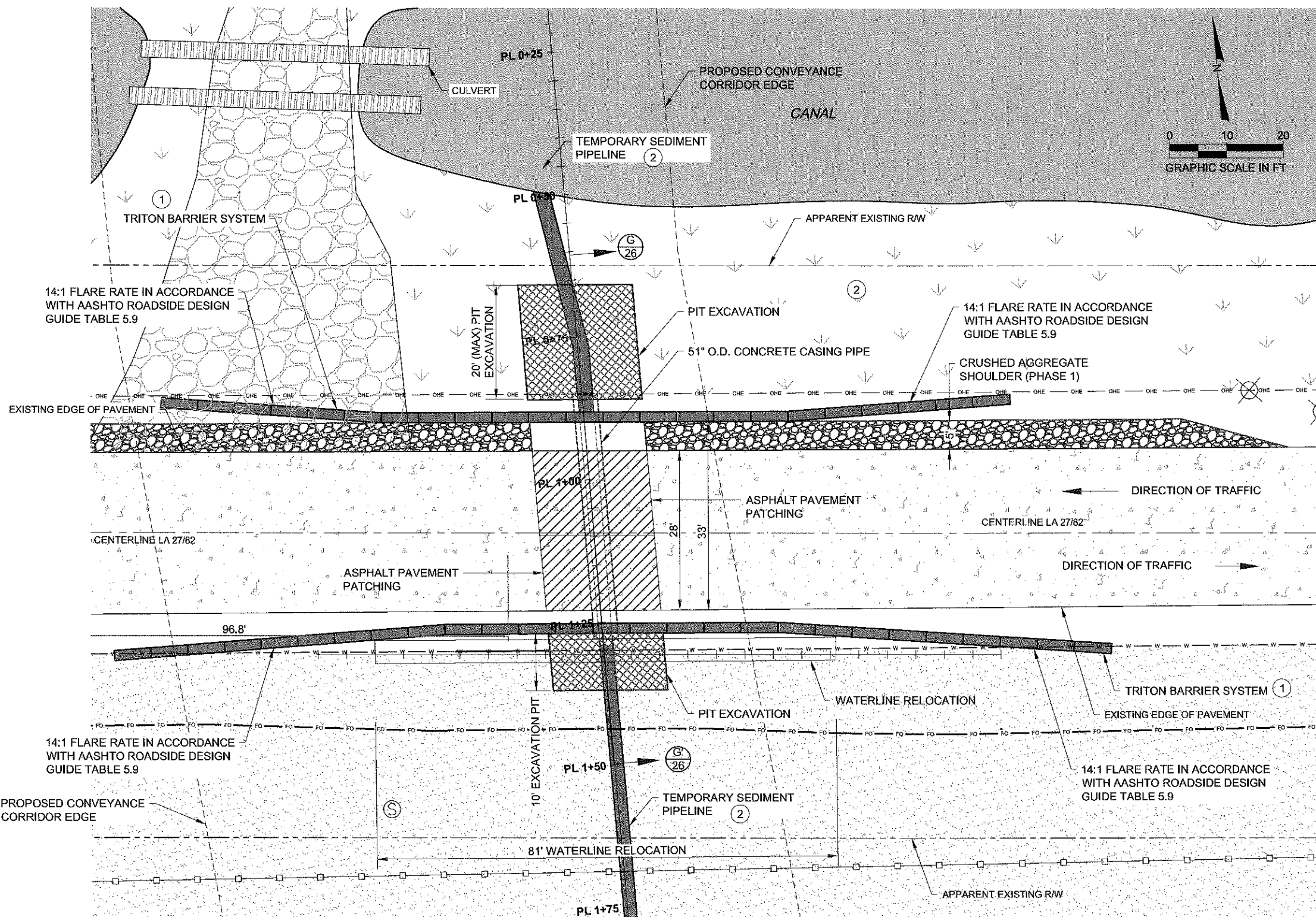

- PHASE 3 (DREDGING OPERATIONS):**
1. PLACEMENT OF TEMPORARY TRAFFIC CONTROL DEVICES SHALL BE INSTALLED AND MAINTAINED AS SHOWN ON THE PLANS UNTIL THE MARSH FILL AREAS HAVE BEEN ACCEPTED, THE TEMPORARY SEDIMENT PIPELINE HAS BEEN REMOVED, AND THE ACCESS PITS HAVE BEEN BACKFILLED. TEMPORARY TRAFFIC CONTROL DEVICES SHALL BE IN ACCORDANCE WITH DOTD TTC-04 PLAN SHEET 35 AND INCLUDE:
 - TRITON BARRIERS
 - TEMPORARY SIGNAGE
 2. FOLLOWING INSTALLATION, THE TEMPORARY SEDIMENT PIPELINE WILL BE LOCATED WITHIN THE CLEAR ZONE.

- NOTES:**
1. ALL TEMPORARY TRAFFIC CONTROL (TTC) DEVICES SHALL BE USED IN ACCORDANCE WITH THE "LOUISIANA STANDARD SPECIFICATIONS FOR ROADS AND BRIDGES", 2006 EDITION, AND THE MUTCD, 2009 EDITION, AND SHALL MEET THE NCHRP REPORT 350 OR MASH REQUIREMENTS FOR TEST LEVEL 3 DEVICES. (SEE SHEETS 30-35)
 2. TRITON BARRIERS SHALL BE USED TO SHIELD FORMIDABLE OBSTACLES FROM PIPELINE AND EQUIPMENT WITHIN THE CLEAR ZONE AS SHOWN IN THE PLANS AND IN ACCORDANCE WITH THE "ROADSIDE DESIGN GUIDE" (AASHTO 4th EDITION, 2011) AND TS-12 OF THE SPECIFICATIONS.
 3. SUFFICIENT SIGNAGE IDENTIFYING THE WORK AREA SHALL BE INSTALLED AND REMAIN THROUGHOUT THE DURATION OF THE PROJECT.
 4. THE CONTACTOR SHALL BE LIABLE FOR ANY DAMAGE TO PIPELINE AND/OR EQUIPMENT BY FORMIDABLE OBSTACLES AND SHALL IMMEDIATELY REPAIR ANY DAMAGE TO THE SEDIMENT PIPELINE CAUSED BY SUCH.
 5. SEE SECTION G-G' ON SHEET 26 FOR PHASE 3 CROSS SECTION VIEW.
 6. FOLLOWING PLACEMENT OF PAVEMENT PATCH, THERMOPLASTIC PAVEMENT MARKINGS SHALL CONFORM TO THE "LOUISIANA STANDARD SPECIFICATIONS FOR ROADS AND BRIDGES", 2006 EDITION, SECTION 732.
 7. SEE TS-12 FOR TRAFFIC MAINTENANCE REQUIREMENTS.
 8. CONTRACTOR MAY WIDEN TURNOUT AT OIL FIELD ROAD AND HIGHWAY 27/82 AS NECESSARY TO FACILITATE ACCESS TO THE PROJECT AREA. SEE TS-12.6.3 FOR DETAILS.

- LEGEND (ABBREVIATIONS):**
- DOTD DEPARTMENT OF TRANSPORTATION AND DEVELOPMENT (LOUISIANA)
 - MUTCD MANUAL ON UNIFORM TRAFFIC CONTROL DEVICES
 - NCHRP NATIONAL COOPERATIVE HIGHWAY RESEARCH PROGRAM
 - RW RIGHT OF WAY
 - O.D. OUTSIDE DIAMETER
 - TTC TEMPORARY TRAFFIC CONTROL

- SEQUENCE LEGEND:**
- ROADWAY EXCAVATION
 - ACCESS EXCAVATION
 - CRUSHED AGGREGATE

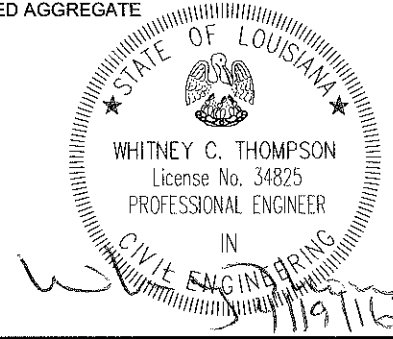

- LEGEND:**
- CONVEYANCE CORRIDOR
 - FENCELINE
 - RIGHT OF WAY LINE
 - OVERHEAD ELECTRIC LINE
 - WATERLINE
 - FIBER OPTIC LINE
 - SANITARY SEWER MANHOLE
 - POWER POLE
 - EXISTING HIGHWAY
 - SAND
 - GRAVEL ROAD
 - MARSH

PLAN VIEW

<p>CB&I COASTAL PLANNING & ENGINEERING, INC. 2481 N.W. BOCA RATON BOULEVARD BOCA RATON, FLORIDA 33431 PH. (561) 391-6102 FAX (561) 391-9116 C.O.A. FL. #4028 C.O.A. LA. #2531 www.CBI.COM</p>				<p>COASTAL PROTECTION AND RESTORATION AUTHORITY 450 LAUREL STREET BATON ROUGE, LOUISIANA 70801</p>		<p>OYSTER BAYOU MARSH RESTORATION PROJECT STATE PROJECT NUMBER: CS-59 FEDERAL PROJECT NUMBER: CS-59 APPROVED BY: WT</p>		<p>LA 27/82 PHASE 3 PLAN VIEW CASING PIPE INSTALLATION SEQUENCE OF CONSTRUCTION DATE: APRIL 13, 2016 SHEET 25 OF 69</p>	
REV.	DATE	DESCRIPTION	BY	DRAWN BY: GK	DESIGNED BY: CP				

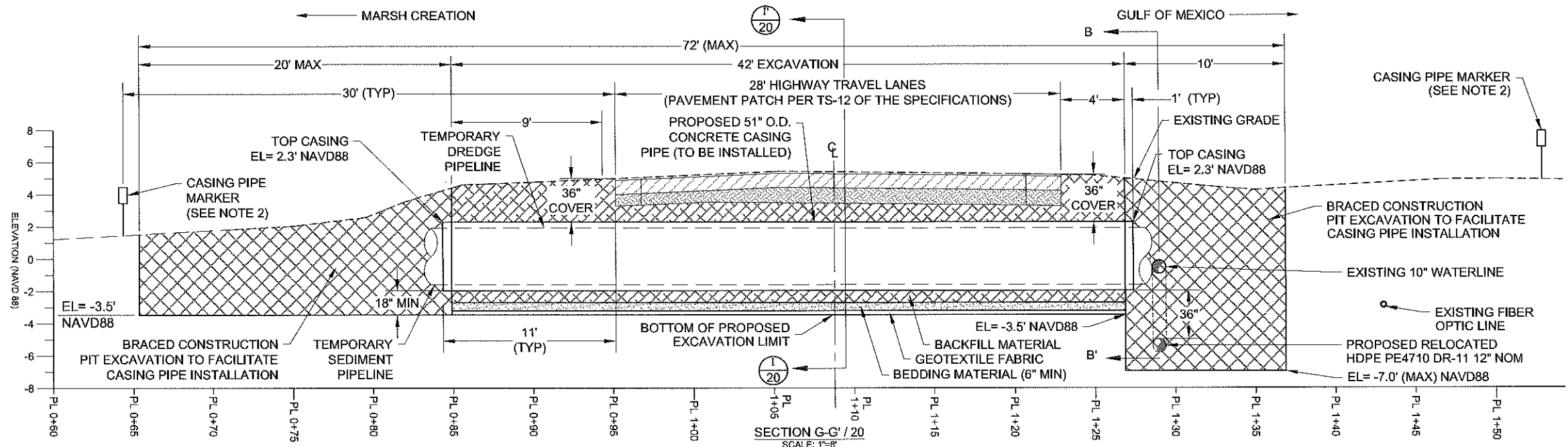

NOTES:

- SEE TS-12 OF THE CONSTRUCTION SPECIFICATIONS FOR INFORMATION REGARDING SEDIMENT PIPELINE HIGHWAY CROSSING REQUIREMENTS.
- SEE SHEET 36 FOR CASING PIPE MARKER CONSTRUCTION DETAILS.
- EXISTING UTILITIES AND/OR PIPELINES NOT SHOWN COULD BE PRESENT IN THE VICINITY OF THE CONVEYANCE CORRIDOR CROSSING OF LA 27/82.
- PRIOR TO CONSTRUCTION, THE CONTRACTOR SHALL VERIFY EXISTING UTILITIES, STRUCTURES AND OTHER EXISTING FEATURES. THE CONTRACTOR SHALL BE FULLY RESPONSIBLE FOR ANY AND ALL DAMAGES THAT MAY BE ATTRIBUTED TO FAILURE TO ACCURATELY LOCATE AND PRESERVE EXISTING UTILITIES, STRUCTURES, AND OTHER FEATURES.
- EXISTING ELEVATIONS, UTILITIES, STRUCTURES, AND FEATURES, AS SHOWN, WERE TAKEN FROM LONNIE G. HARPER AND ASSOCIATES TOPOGRAPHIC AND MAGNETOMETER SURVEY, DATED MARCH 2015.
- ONE LANE SHALL REMAIN OPEN AT ALL TIMES DURING CASING PIPE INSTALLATION. THE WEST BOUND LANE SHALL BE WIDENED USING CRUSHED AGGREGATE CONFORMING TO THE LOUISIANA STANDARD SPECIFICATIONS FOR ROAD AND BRIDGES, 2006 EDITION, STANDARD SPECIFICATION 1003.04 (a). A TRITON BARRIER OR APPROVED EQUIVALENT SHALL BE INSTALLED ALONG THE CENTERLINE OF LA 27/82 TO SEPARATE VEHICULAR TRAFFIC FROM THE OPEN-CUT. TRAFFIC CONTROL SHALL BE CONDUCTED PER PLAN SHEETS 23-25, 28-29, AND 30-35.
- SEE SPECIFICATIONS SECTION 203 FOR EXCAVATION, EMBANKMENT, AND GEOTEXTILE FABRIC. SEE SECTION 302 FOR CLASS II BASE COURSE. SEE SPECIFICATION SECTIONS 502 AND 510 FOR ASPHALTIC CONCRETE PATCHING. SEE SPECIFICATION SECTION 701 FOR CONCRETE CASING PIPE. SEE SPECIFICATION SECTION 726 FOR BEDDING MATERIAL. THESE SPECIFICATIONS ARE FROM "LOUISIANA STANDARD SPECIFICATIONS FOR ROAD AND BRIDGES", 2006 EDITION FROM THE LOUISIANA DEPARTMENT OF TRANSPORTATION AND DEVELOPMENT (DOTD) SPECIFICATIONS LOCATED IN APPENDIX VIII.
- ALL JOINTS SHALL BE RESTRAINED.
- SEE SHEET 21 AND 22 FOR WATERLINE RELOCATION DETAILS.

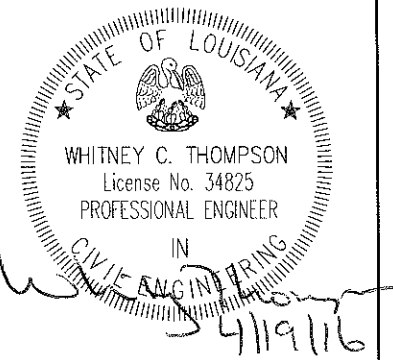
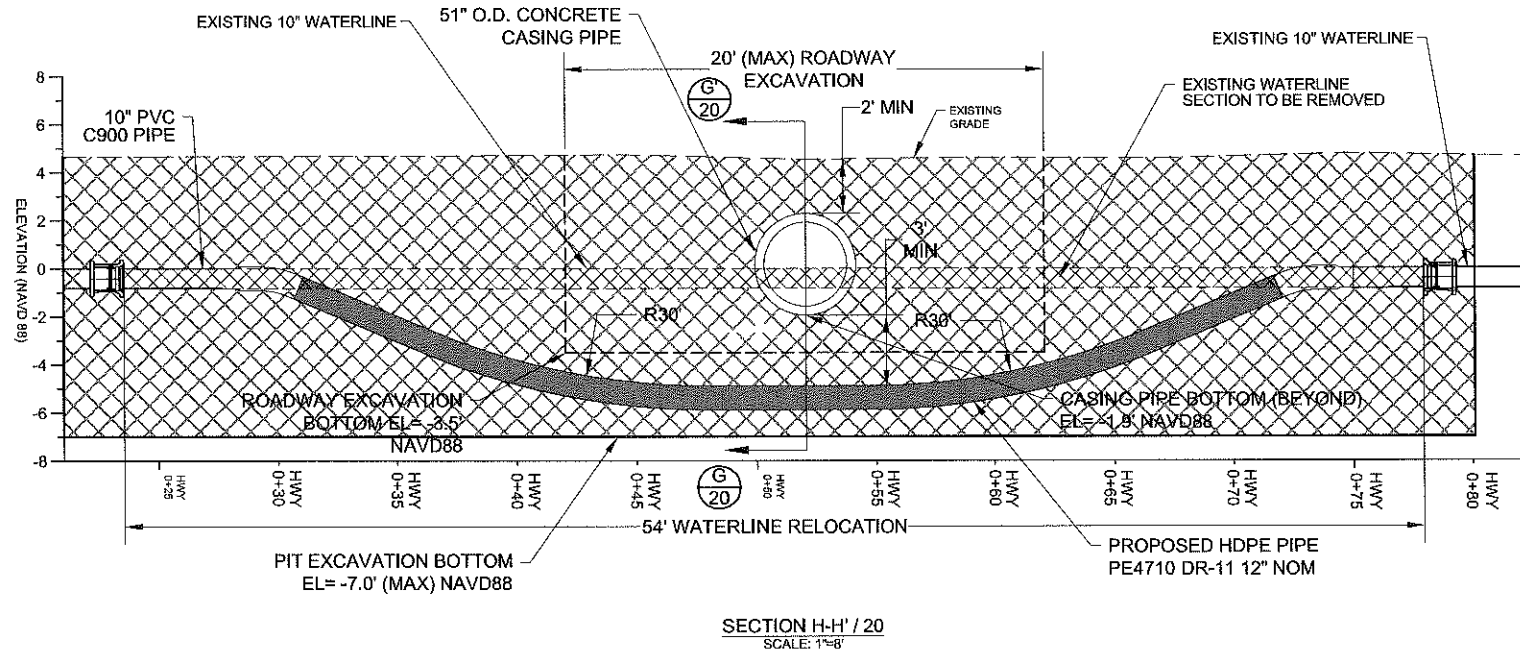

LEGEND (ABBREVIATIONS):

- DIP DUCTILE IRON PIPE
- HDPE HIGH DENSITY POLYETHYLENE
- PVC POLYVINYL CHLORIDE
- HWY HIGHWAY
- NAVD NORTH AMERICAN VERTICAL DATUM
- I.D. INSIDE DIAMETER
- O.D. OUTSIDE DIAMETER
- EL ELEVATION
- MJ MECHANICAL JOINT
- NOM NOMINAL
- TYP TYPICAL
- SECTION ID SECTION PAGE LOCATION

REV.	DATE	DESCRIPTION	BY

CB&I COASTAL PLANNING & ENGINEERING, INC.
 2481 N.W. BOCA RATON BOULEVARD
 BOCA RATON, FLORIDA 33431
 PH. (561) 391-8102
 FAX (561) 391-9116
 C.O.A. FL. #4028
 C.O.A. LA. #2531
 www.CBI.COM

COASTAL PROTECTION AND RESTORATION AUTHORITY
 450 LAUREL STREET
 BATON ROUGE, LOUISIANA 70801
 DRAWN BY: GK
 DESIGNED BY: CP

OYSTER BAYOU MARSH RESTORATION PROJECT
 STATE PROJECT NUMBER: CS-59
 FEDERAL PROJECT NUMBER: CS-59
 APPROVED BY: WT

LA 27/82 CROSSING OPEN CUT EXCAVATION SECTIONS G-G' AND H-H'
 DATE: APRIL 13, 2016
 SHEET 26 OF 69

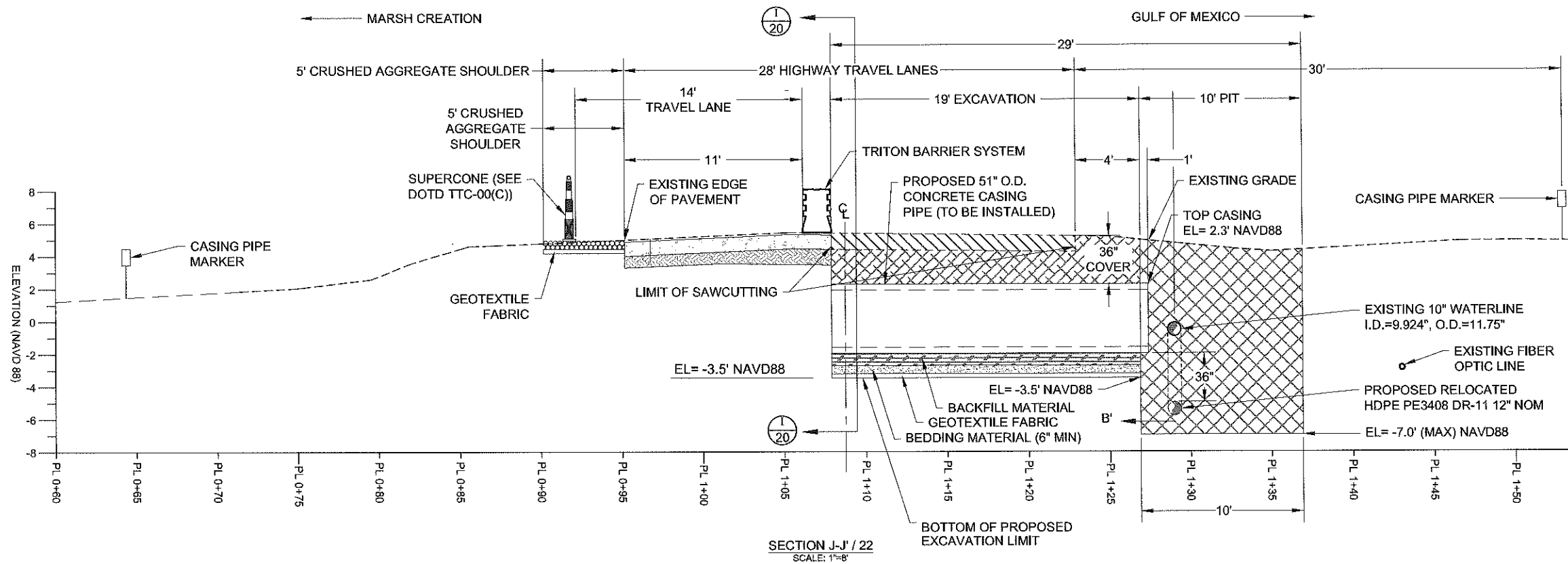

SECTION J-J' / 22
SCALE: 1"=8'

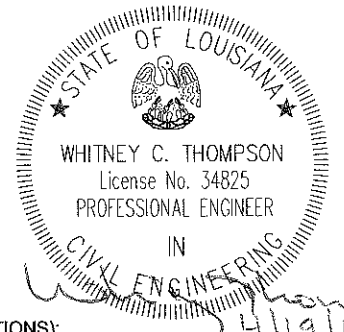

LEGEND (MATERIAL)

- EXISTING PAVEMENT
- PAVEMENT PATCH
- BEDDING MATERIAL
- BACKFILL MATERIAL
- ACCESS PIT EXCAVATION
- ROADWAY EXCAVATION
- EXISTING GRADE

SECTION ID
 SECTION PAGE LOCATION

LEGEND (ABBREVIATIONS):

- DOTD DEPARTMENT OF TRANSPORTATION AND DEVELOPMENT (LOUISIANA)
- EL ELEVATION
- HDPE HIGH DENSITY POLYETHYLENE
- HWY HIGHWAY
- NAVD NORTH AMERICAN VERTICAL DATUM
- NOM NOMINAL
- PL PROFILE LINE
- INSI INSIDE DIAMETER
- O.D. OUTSIDE DIAMETER

		CB&I COASTAL PLANNING & ENGINEERING, INC. 2481 N.W. BOCA RATON BOULEVARD BOCA RATON, FLORIDA 33431 PH. (561) 391-8102 FAX (561) 391-8116 C.O.A. FL. #4028 C.O.A. LA. #2331 www.CBI.COM		COASTAL PROTECTION AND RESTORATION AUTHORITY 450 LAUREL STREET BATON ROUGE, LOUISIANA 70801		OYSTER BAYOU MARSH RESTORATION PROJECT		LA 27/82 CROSSING PHASE 1 SECTION J-J' CASING AND PIPELINE INSTALLATION	
						STATE PROJECT NUMBER: CS-59		FEDERAL PROJECT NUMBER: CS-59	
REV.	DATE	DESCRIPTION	BY	DRAWN BY: GK		DESIGNED BY: CP		APPROVED BY: WT	
								SHEET 28 OF 69	

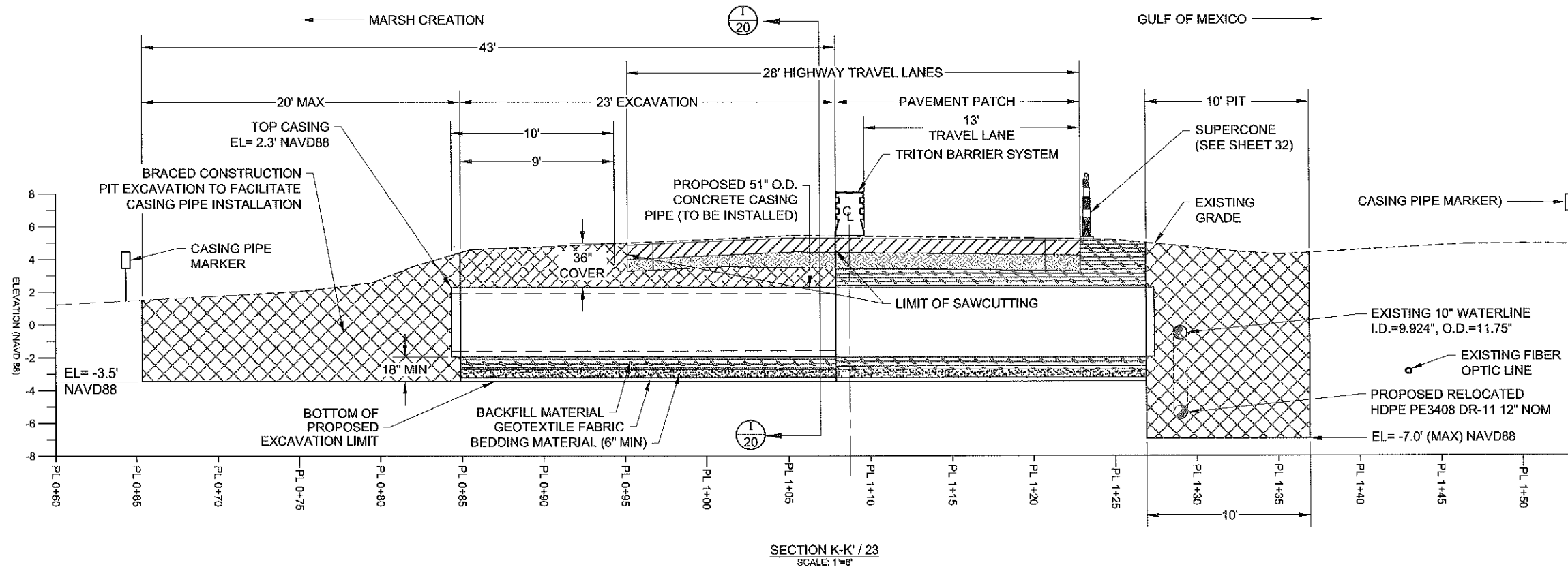

SECTION K-K' / 23
SCALE: 1"=8'

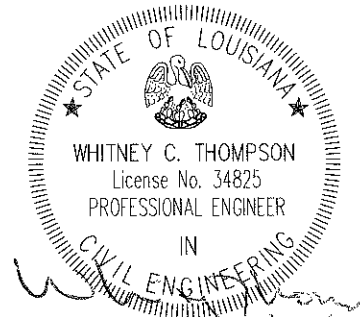

LEGEND (ABBREVIATIONS):

- DOTD DEPARTMENT OF TRANSPORTATION AND DEVELOPMENT (LOUISIANA)
- EL ELEVATION
- HDPE HIGH DENSITY POLYETHYLENE
- HWY HIGHWAY
- NAVD NORTH AMERICAN VERTICAL DATUM
- NOM NOMINAL
- PL PROFILE LINE
- I.D. INSIDE DIAMETER
- O.D. OUTSIDE DIAMETER

LEGEND (MATERIAL)

- EXISTING PAVEMENT
- PAVEMENT PATCH
- BEDDING MATERIAL
- BACKFILL MATERIAL
- ACCESS PIT EXCAVATION
- ROADWAY EXCAVATION
- EXISTING GRADE

SECTION ID
 SECTION PAGE LOCATION

REV.	DATE	DESCRIPTION	BY

CB&I COASTAL PLANNING & ENGINEERING, INC.
 2481 N.W. BOCA RATON BOULEVARD
 BOCA RATON, FLORIDA 33431
 PH. (561) 391-8102
 FAX (561) 391-9116
 C.O.A. FL. #4028
 C.O.A. LA. #2531
 www.CBI.COM

COASTAL PROTECTION AND RESTORATION AUTHORITY
 450 LAUREL STREET
 BATON ROUGE, LOUISIANA 70801
 DRAWN BY: GK
 DESIGNED BY: CP

OYSTER BAYOU MARSH RESTORATION PROJECT
 STATE PROJECT NUMBER: CS-59
 FEDERAL PROJECT NUMBER: CS-59
 APPROVED BY: WT

LA 27/82 CROSSING PHASE 1 SECTION K-K' CASING AND PIPELINE INSTALLATION
 DATE: APRIL 13, 2016
 SHEET 29 OF 69

GENERAL PROVISIONS

- All temporary traffic control (TTC) devices used shall be in accordance with the Louisiana Standard Specifications for Roads and Bridges, the MUTCD, and shall meet the NCHRP Report 350 or MASH requirements for Test Level 3 devices where applicable.
- Materials used for TTC shall be in accordance with the Louisiana Standard Specifications for Roads and Bridges and, when applicable, the LADOTD QPL.
- No TTC shall be erected without the approval of the Engineer and until work is about to begin, unless they are covered.
- No lane closures, lane shifts, diversions, or detours shall occur without the approval of the Engineer.
- Responsibility is hereby placed upon the contractor for the installation, maintenance, and operation of all TTC devices called for in these plans or required by the Engineer for the protection of the traveling public as well as all LADOTD and construction personnel.
- The contractor shall also be responsible for the maintenance of all permanent signs, pavement markings, and traffic signals left in place as essential to the safe movement and guidance of traffic within the project limits unless noted in the plans.
- The DTOE shall serve as a technical advisor to the Engineer for all traffic control matters.
- The Chief Construction Engineer or his appointed designee shall approve all signs and situations not addressed in the plans based on the recommendations of the Project Engineer and the DTOE. All changes shall be noted in all project traffic control diaries.
- The Chief Construction Engineer or his appointed designee shall approve all design speeds of diversions or shifts if it differs from design plans, based on the recommendations of the Project Engineer and the DTOE.
- All temporary traffic control plans shall comply with the Transportation Management Plan.
- Any additional signs shown in the MUTCD and required by the Engineer shall be installed under Item 713-01-00100.
- Neither work activity nor storage of equipment, vehicles, TMAs, or materials shall occur within the buffer space.
- When a work area has been established on one side of the roadway only, there shall be no conflicting operations or parking on the opposite shoulder within 500 feet of the work area.
- A lighting plan shall be submitted to the Engineer 30 days prior to night work for approval. (See section 105.20 of the Louisiana Standard Specifications for Roads and Bridges.)
- Parking of vehicles or unattended equipment, or storage of materials, within the clear zone shall not be permitted unless protected by guard rail or barriers. If the clear zone is not defined on the plan sheets, the Engineer shall verify.
- Immediately upon removal of existing guard rail, the contractor shall install and maintain an NCHRP Report 350 or MASH approved device to protect the blunt end of the bridge or column until new guard rail is installed. After removal of the existing guard rail, new guard rail should be installed within seven (7) days. On non-NHS routes with shoulders less than 8 feet wide: If an NCHRP 350 Report Test Level 3 or MASH device is required but the field conditions of the roadway cannot support a Test Level 3 device, then a Test Level 2 device can be substituted in its place upon approval by the Engineer.
- All costs associated with crash devices are to be included in Item 713-01-00100.
- Sight distance should be considered when placing traffic control devices.
- On all mainline Interstate, a minimum of 1.5 feet of paved shoulder on the left and right side shall be maintained at all times.
- On Interstates, a minimum of 11 foot lanes shall be maintained. On all other roadways, a 10 foot minimum travel lane should be maintained where practical.

- TTC Standards are not drawn to scale.
 - The contractor shall develop an internal traffic control plan approved by the Engineer prior to each phase.
 - Truck restrictions such as (but not limited to) restricting lanes, oversize loads or times of travel, may be required for narrow lanes or other field conditions.
- PAVEMENT MARKINGS (see QPL)**

- All pavement markings within the limits of the project that are in conflict with the project signing or the required traffic movements shall be removed from the pavement by blast cleaning or grinding. (Existing striping shall not be painted over with black paint or covered with tape.)
- If special pavement markings are needed, they shall be reflectorized, removable, and accompanied by the proper signage.
- Temporary Raised Pavement Markers may be added to supplement temporary striping in areas of transition, in tapers, in diversions, and in other areas of need as shown in the plans or as directed by the Engineer.
- Materials and placement of temporary pavement markings shall conform to Section 713 of the Louisiana Standard Specifications for Roads and Bridges. If no pay item exists for temporary markings they shall be installed under item 713-01-00100.
- Temporary markings installed in the permanent configuration shall comply with LADOTD pavement marking standard plans, MUTCD, and/or the permanent striping plans.

PORTABLE CHANGEABLE MESSAGE SIGNS (PCMS)

- PCMS shall be used on all Interstate Highways and on all other roadways (where space is available) with an ADT greater than 20,000.
- When used in advance of a lane closure or a lane shift, the PCMS should be placed on the right hand side of the road a minimum distance of 2 miles in advance of the taper for interstates and to be determined by the Engineer on other highways.
- For interstates and multi-lane highways, if vehicles are queuing beyond the 2 mile PCMS, an additional PCMS should be placed on the right hand side of the road approximately 5 miles in advance of the taper or at the end of the queue, whichever is greater.
- PCMS messages shall conform to EDMS V 2.1.10 or shall be approved by the DTOE. Messages shall be no more than 7 lines and 2 screens.
- PCMS should be placed as far from the traveled lane as possible. They shall be shielded by guard rail or barriers. If this is not possible they shall be delineated with one drum at each corner.
- If the PCMS has to be placed on the shoulder then the contractor shall install a shoulder closure.
- When the PCMS is not displaying a work zone appropriate message pertaining to the ongoing construction project it shall be shielded by guard rail or barriers, or removed from the clear zone.

ABBREVIATIONS

- AASHTO American Association of State Highway and Transportation Officials
- ADT Average Daily Traffic
- AGCI Associated General Contractors of America
- ANSI American National Standards Institute
- ATSSA American Traffic Safety Services Association
- B.O.P. Beginning of Project
- DTOE District Traffic Operations Engineer
- E.O.P. End of Project
- LADOTD Louisiana Department of Transportation and Development
- MASH AASHTO Manual for Assessing Safety Hardware
- MUTCD Manual on Uniform Traffic Control Devices
- NCHRP National Cooperative Highway Research Program
- NHS National Highway System
- PCMS Portable Changeable Message Sign
- QPL Qualified Products List
- TMA Truck Mounted Attenuator
- TMC Traffic Management Center
- TTC Temporary Traffic Control
- TTC Standards .. Temporary Traffic Control Standard Plans

SPEED LIMITS

- The Engineer may approve a 10 mph drop in the speed limit for posted speeds of 45 mph or greater and for any construction, maintenance, or utility operation that requires one or more of the following:
 - (A) The condition of the traveled way is degraded due to milled surfaces or uneven travel lane lines greater than 1.5 inches.
 - (B) Work is in progress in the immediate vicinity of the travel way requiring lane closures or lane width reductions less than 11 feet.
 - (C) Workers present on the shoulder within 2 feet of the edge of the traveled way without barrier protection.
- The reduced speed zone shall only apply to those portions of the project limits affected. The Engineer may allow SPEED LIMIT WHEN FLASHING signs to supplement reduced speed zones.
- If the speed limit is reduced, speed limit signs shall be placed:
 - (A) beyond major intersections;
 - (B) at one mile intervals in rural areas;
 - (C) at half mile intervals in urban areas.
- At the end of the reduced speed zone, a speed limit sign displaying the original speed limit prior to construction shall be installed.
- For all other speed limit reductions not listed above the Project Engineer and the DTOE shall recommend the speed reduction to the Chief Construction Engineer or his appointed designee for approval.
- If the speed limit is reduced more than 10 mph, placement of the signs shall be re-evaluated according to the MUTCD.

FLASHING ARROW BOARDS

- All Flashing Arrow Boards shall be 4 feet by 8 feet and Type C.
- Flashing Arrow Boards should be placed on the shoulder. When there is no shoulder or median area, the arrow board shall be placed within the closed lane behind the channelizing devices and as close to the beginning of the taper as practical.
- Flashing arrow boards shall be delineated with retroreflective TTC devices.
- At no time shall the arrow board encroach in the traveled way. When Flashing Arrow Board signs are not being used, they shall be shielded by guard rail or barriers, or removed.
- Arrow boards shall only be used for lane reduction tapers and shall not be used for lane shifts.

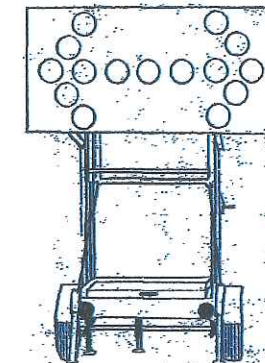
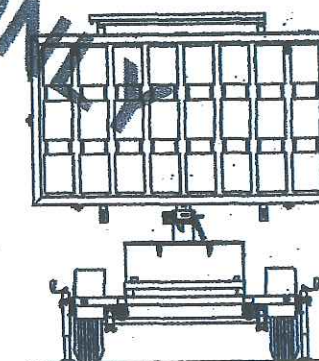

ALL TTC STANDARDS SHOW MINIMUM CONSTRUCTION SIGNING.
ALL SITUATIONS SHALL BE REVIEWED AND/OR DESIGNED BY THE ENGINEER.
CONTRACTORS ARE RESPONSIBLE FOR COMPLYING WITH ALL TTC STANDARDS.

FOR INFORMATIONAL PURPOSES ONLY

SHEET NUMBER	30	DATE	02/13/2013	PROJECT	
DESIGNED BY	COLVIN	DRAWN BY	COLVIN	DATE	02/13/2013
CHECKED BY	COLVIN	DATE	02/13/2013	PROJECT	
APPROVED BY		DATE	3-12-13	PROJECT	
REVISION DESCRIPTION					
TEMPORARY TRAFFIC CONTROL GENERAL NOTES SHEET					
TTC-00 (A)					
TRAFFIC ENGINEERING					

SIGNS

- All signs used for temporary traffic control shall follow the plans, the LADOTD TTC Standards, and the MUTCD.
- Signs shown in the TTC illustrations are typical and may vary with each specific condition.
- One Type B High Intensity light shall be used to supplement the first sign (or pair of signs) that gives warning about a lane closure during nighttime operations (see QPL).
- Mesh rollup signs shall not be allowed on any project.
- Contractor shall use caution not to damage existing signs which remain in place. Any LADOTD signs damaged by work operations shall be replaced by the contractor under item 713-01-00100.
- All signs (permanent and temporary) shall be removed or completely covered with a strong, lightweight, opaque material when no longer applicable. (Burlap is not an acceptable material to cover signs).
- At no time shall signs warning against a particular operation be left in place once the operation has been completed or when the condition has been removed.
- Warning signs used for temporary traffic controls shall meet the following guidelines unless otherwise noted in the plans:
 - (A) size shall be 48 inches by 48 inches.
 - (B) see the Louisiana Standard Specifications for Roads and Bridges and the QPL for sheeting information.
 - (C) lateral distance of signs shall be a minimum of 6 feet from the edge of shoulder or edge of pavement if no shoulder exists, and 2 feet from the back of curb in urban areas (see diagram).
- When portable sign frames are not in use they shall be moved to an area inaccessible to traffic and not visible to the driver.
- Left side mounted signs will not be required for roadways with a center left turn lane and for undivided roadways.
- Vinyl rollup signs may be used if work zone is in place for 12 hours or less, there are no more than 2 lanes in each direction and if signs meet all size, color, retroreflectivity, and NCHRP 350 Report or MASH requirements.
- All signs shall be visible to the drivers (i.e. no obstructions such as on street parking or other traffic control devices shall block the sign).
- On divided highways, signs shall be placed on the right and the left as shown on the TTC standards.
- 1 foot portable sign stands may be used if the work zone is in place for 12 hours or less, the preconstruction posted speed is less than 45 mph and there are no more than 2 lanes in each direction.
- Sign posts:
 - Signs measuring 10 square feet or less shall be mounted on 1 rigid post
 - Signs over 10 square feet shall be mounted on 2 rigid posts
 - Signs over 20 square feet shall be mounted on at least 3 rigid posts
- Rigid sign supports shall be driven to a minimum depth of 3 feet. (If splicing is required, see Allowable Lap Splice U-channel post.)
- For sign height, see the Rural and Urban diagrams:

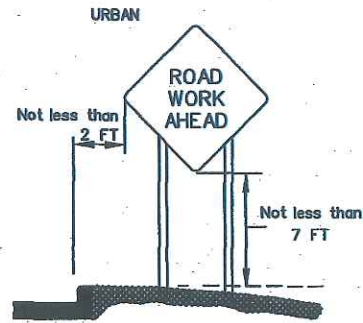

LANE CLOSURES

- All proposed lane, road, or shoulder closures shall be reviewed by the DTOE and approved by the Engineer.
- Two lane, two-way highways shall have a maximum work area of two miles; all other roadways shall have a four mile maximum work area.
- A queue analysis shall be performed prior to approval of lane closures on all Interstates according to EDSM VI.1.1.4.
- Closure plans and times shall be turned in to the Engineer for review according to the following:
 - (A) 5 working days minimum if traffic control plan has been approved or is contained in the plans.
 - (B) 10 working days minimum and a traffic control plan must be submitted for lane closures not addressed in the plans.
- Weekly updates to the DTOE, Project Engineer, the LADOTD TMC operator, and the regional TMC operator (if applicable) will be required for all ongoing lane closures to update closure status.
- Daily updates to the DTOE, Project Engineer, and TMC operator (if applicable) will be required for all projects where active closures are in place.

FLAGGERS

- All flaggers shall be qualified.
- The contractor shall be responsible for training and ensuring that all flaggers are qualified to perform flagging duties.
- A Qualified Flagger is one that has completed courses such as those offered by ATSSA, AGC, or other courses approved by the LADOTD Work Zone Task Force. The contractor shall be responsible for getting the flagger course approved.
- When utilized, a flagger shall use a minimum 18 inch octagonal shape sign on a minimum 6 foot stop/slow paddle and wear ANSI Class 2 Lime Green vest during day time operations and ANSI Class 3 Lime Green ensemble during night operations.
- In all flagging operations, the flagger must be visible from the flagger advance warning sign.
- Flaggers shall not be used on the Interstate.

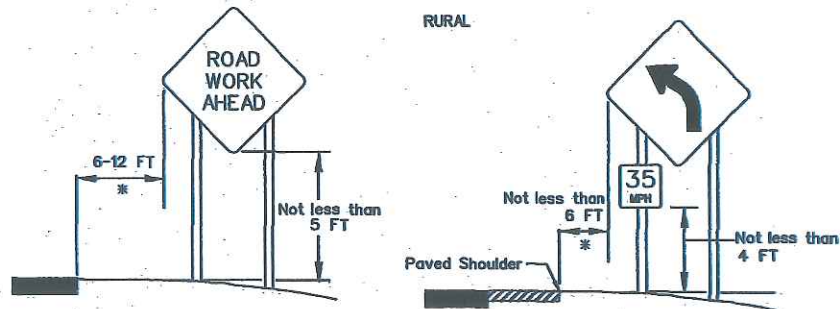
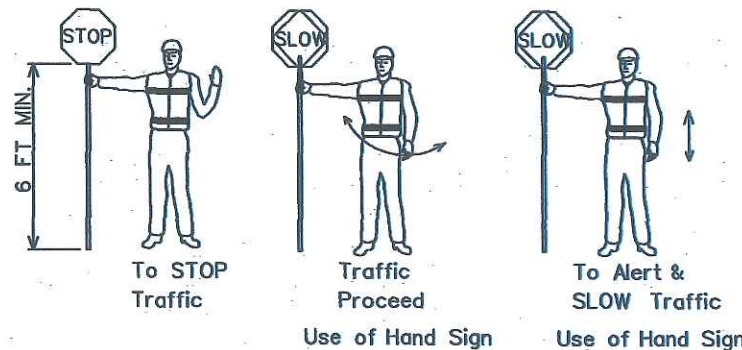

* If lateral distance is not practical, the sign may be placed no less than 2 feet.

REFERENCES

- The contractor shall be responsible for understanding all rules and requirements in the current edition of the following documents:
 - 1) Louisiana Standard Specifications for Roads and Bridges. <http://www.dotd.la.gov/highways/specifications/>
 - 2) Manual on Uniform Traffic Control Devices for Streets and Highways (MUTCD). <http://mutcd.fhwa.dot.gov/>
 - 3) LADOTD Qualified Products List (QPL) Manual. <http://www.dotd.la.gov/highways/construction/lab/qpl/tableofcontents.shtml>
 - 4) LADOTD Engineering Directives and Standards Manual (EDSM) VI.1.1.4 - Queue Analysis for Interstate Lane Closures. <http://webmail.dotd.la.gov/ppmemos.nsf>
 - 5) National Cooperative Highway Research Program (NCHRP) Report 350: "Guidelines for Work Zones Traffic Control Devices". http://onlinepubs.trb.org/Onlinepubs/nchrp/nchrp_rpt_350-a.pdf
 - 6) NCHRP Report 475: "A Procedure for Assessing and Planning Nighttime Highway Construction and Maintenance". http://onlinepubs.trb.org/Onlinepubs/nchrp/nchrp_rpt_475.pdf
 - 7) NCHRP Report 476: "Guidelines for Design and Operation of Nighttime Traffic Control for Highway Maintenance". http://onlinepubs.trb.org/Onlinepubs/nchrp/nchrp_rpt_476.pdf
 - 8) NCHRP Report 498: "Illumination Guidelines for Nighttime Highway Work". http://onlinepubs.trb.org/Onlinepubs/nchrp/nchrp_rpt_498.pdf
 - 9) American Association of State Highway and Transportation Officials (AASHTO) Roadside Design Guide.
 - 10) American Traffic Safety Services Association (ATSSA) Quality Guidelines for Work Zone Traffic Control Devices and Features. U.S. Department of Transportation Federal Highway Administration Traffic Control Handbook for Mobile Operations at Night. <http://www.dot.state.il.us/blr/1023.pdf>
 - 12) LADOTD Engineering Directives and Standards Manual (EDSM) VI.2.1.10 - PCMS Approved Construction Message Policy. <http://webmail.dotd.la.gov/ppmemos.nsf>

ALL TTC STANDARDS SHOW MINIMUM CONSTRUCTION SIGNING. ALL SITUATIONS SHALL BE REVIEWED AND/OR DESIGNED BY THE ENGINEER. CONTRACTORS ARE RESPONSIBLE FOR COMPLYING WITH ALL TTC STANDARDS.

SHEET NUMBER		31	
DESIGNED	J. COLVIN	PARTIAL	
CHECKED	P. ALLAIN	FEDERAL PROJECT	
DETAILS	M.D. ORDOGNE	STATE PROJECT	
CHECKED	J. COLVIN	DATE	02/15/2013
DATE		SHEET	
REVISION DESCRIPTION		BY	
		DATE	3-11-13
APPROVED BY		CHIEF ENGINEER	
TEMPORARY TRAFFIC CONTROL GENERAL NOTES SHEET TTC-00 (B)			
TRAFFIC ENGINEERING			

CHANNELIZING DEVICES

- The following devices may be used as channelizing devices: Tubular Markers, Vertical Panels, Cones, Drums, and Super Cones.
- 28 inch traffic cones are not allowed on:
 - Interstates
 - Highways with speeds greater than 40 mph.
- During nighttime operations 28 inch and 36 inch cones are not allowed.
- Retroreflective material pattern used on super cones shall match that used on drums.
- Tangent Areas:**
 - Standard Spacing:** See Standard Device Spacing and Buffer Space table.
 - Daylight Operations:** Drums and super cones are spaced at standard spacing. All other devices are at 1/2 standard spacing.
 - Nighttime Operations:** Drums and supercones at standard spacing are the only devices allowed.
- Taper Areas:**
 - Standard Spacing:** See Standard Device Spacing and Buffer Space table.
 - Daylight Operations:** Drums are spaced at standard spacing. All other devices are 1/2 standard spacing.
 - Nighttime Operations:** Drums (at standard spacing) are the only devices allowed.
- Type C steady burn lights shall be used on all channelizing devices in the taper as well as the first two devices in the tangent at night, (see the QPL).
- Typical channelizing device lateral placement (do not include when it is used as a divider for opposing directions of traffic) shall be 2 feet off the lane line in the closed lane or shoulder.
- Devices may be adjusted laterally to accommodate ongoing work in the immediate vicinity but must be returned to the closed lane after the work activity has moved.
- Channelizing devices on the lane line shall be of the same type.
- Channelizing devices in each taper shall be of the same type.

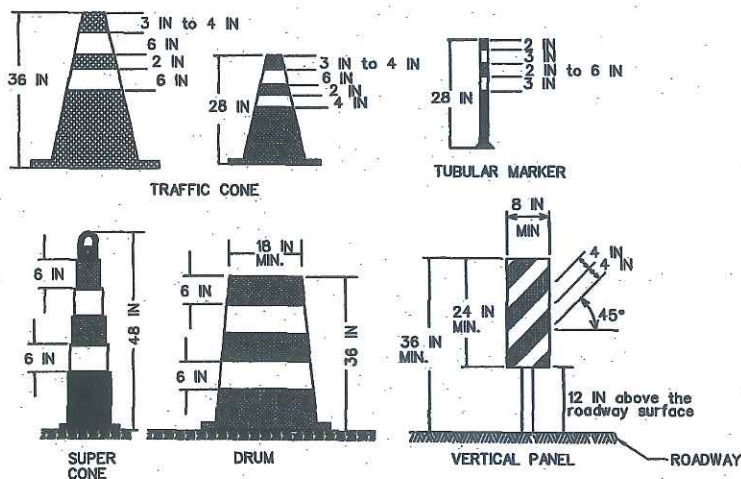

ALL TTC STANDARDS SHOW MINIMUM CONSTRUCTION SIGNING.
ALL SITUATIONS SHALL BE REVIEWED AND/OR DESIGNED BY THE ENGINEER.
CONTRACTORS ARE RESPONSIBLE FOR COMPLYING WITH ALL TTC STANDARDS.

TYPE III BARRICADES

- Only Type III barricades shall be used.
- All barricades shall use Type 3 High Intensity Sheeting on both sides of the barricade.
- All barricades shall be a minimum of 8 feet in length and must meet NCHRP Report 350 or MASH requirements.
- When used for overnight closures, two Type B High Intensity lights shall supplement all barricades that are placed in a closed lane or that extend across a highway. Two Type A Low Intensity lights may be used in urban areas if approved by the Engineer (see QPL).
- When signs and lights are to be mounted to a barricade, they must meet NCHRP Report 350 or MASH requirements.
- A truck with a TMA may be substituted for a barricade when workers are present.
- Barricades shall be placed:
 - at the beginning of a closed lane or shoulder and at 1,000 foot intervals where no active work is ongoing and the lane must remain closed. A minimum of 2 barricades shall be placed if the lane or shoulder closure is less than 2,000 feet. (One barricade shall be placed at the beginning of the lane closure after the buffer space and one shall be placed in the middle of the lane closure.)
 - before each or group of unfilled holes or holes filled with temporary material.
 - before uncured concrete.
 - in a closed lane on each side of every intersection and crossover. Do not block sight distance.)
 - in front of piles of material (dirt, aggregate, broken concrete), culverts, and equipment which is near the work zone.

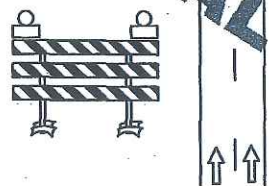

TTC for DROP-OFFS

NON-INTERSTATE		
Average Drop-off	> 45 MPH	≤ 45 MPH
≤ 3 IN	Low Shoulder Sign (Optional)	Low Shoulder Sign (Optional)
> 3 IN	Shoulder Drop Off Sign & Edge Lines or Shoulder Drop Off Sign & Channelizing Device	Shoulder Drop Off Sign
> 6 IN	No Shoulder Sign, Edge Lines & Vertical Panel	No Shoulder Sign & Channelizing Device
> 10 IN	Concrete Barrier & Edge Lines	No Shoulder Sign & Vertical Panel
INTERSTATE		
Average Drop-off		
≤ 2 IN	Low Shoulder Sign (Optional)	
> 2 IN	Shoulder Drop Off Sign & Edge Lines or Shoulder Drop Off Sign & Channelizing Device	
> 6 IN	Shoulder Drop Off Sign, Concrete Barrier & Edge Lines	

- If a portable concrete barrier will be required then the deflection shall be considered in the design.
- For Interstate ramps, refer to non-Interstate drop offs.

STANDARD DEVICE SPACING AND BUFFER SPACE

SPEED LIMIT (prior to construction)	MERGING TAPER LENGTH (L)				STANDARD DEVICE SPACING IN FEET		BUFFER SPACE
	Lane Width (FT)				Along Taper	Along Tangent	
MPH	9	10	11	12	Along Taper	Along Tangent	FT
25	94	105	115	125	20	40	155
30	135	150	165	180	40	80	200
35	184	205	225	245	40	80	250
40	240	267	294	320	40	80	305
45	405	450	495	540	40	80	360
50	450	500	550	600	40	80	425
55	495	550	605	660	40	80	495
60	540	600	660	720	40	80	570
65	585	650	715	780	40	80	645
70	630	700	770	840	40	80	730

SPEED LIMIT (prior to construction)	SHIFTING TAPER LENGTH (1/2)L				STANDARD DEVICE SPACING IN FEET		BUFFER SPACE
	Lane Width (FT)				Along Taper	Along Tangent	
MPH	9	10	11	12	Along Taper	Along Tangent	FT
25	47	53	58	63	20	40	155
30	68	75	83	90	40	80	200
35	92	103	113	123	40	80	250
40	120	134	147	160	40	80	305
45	203	225	248	270	40	80	360
50	225	250	275	300	40	80	425
55	248	275	303	330	40	80	495
60	270	300	330	360	40	80	570
65	293	325	358	390	40	80	645
70	315	350	385	420	40	80	730

SPEED LIMIT (prior to construction)	SHOULDER TAPER LENGTH (1/3)L				STANDARD DEVICE SPACING IN FEET		BUFFER SPACE
	Lane Width (FT)				Along Taper	Along Tangent	
MPH	9	10	11	12	Along Taper	Along Tangent	FT
25	32	35	39	42	20	40	155
30	45	50	55	60	40	80	200
35	62	69	75	82	40	80	250
40	80	89	98	107	40	80	305
45	135	150	165	180	40	80	360
50	150	167	184	200	40	80	425
55	165	184	202	220	40	80	495
60	180	200	220	240	40	80	570
65	195	217	239	260	40	80	645
70	210	234	257	280	40	80	730

- All termination and flagger tapers are 100 feet per lane. (MIN. 6 channelizing devices per lane equally spaced 20 feet apart.) See TTC Standards for flagger taper.
- See MNTCD for taper formulas.

ALLOWABLE LAP SPLICE FOR U-CHANNEL POST

- U-Channel posts may be spliced where long lengths are required. The upper section shall overlap the lower section by at least 24 inches. The bottom edge of the upper section of the splice shall be a minimum of 24 inches above the ground. The spliced sections shall be secured with at least four 5/16 inch diameter hex bolts spaced equally along the splice.

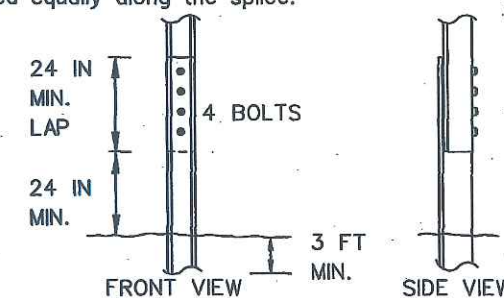

SHEET NUMBER **32**

REVISION DESCRIPTION

DATE 02/15/2013

DATE 3-12-13

APPROVED BY

CHIEF ENGINEER

TEMPORARY TRAFFIC CONTROL GENERAL NOTES SHEET

TTC-00 (C)

TRAFFIC ENGINEERING

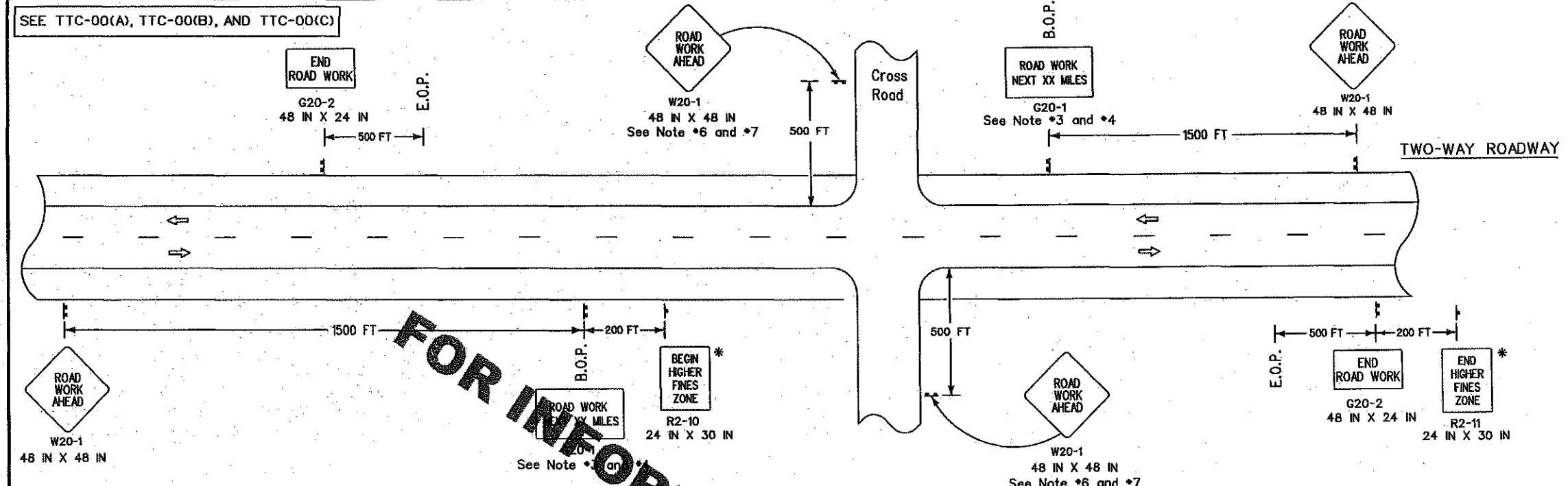

FOR INFORMATIONAL PURPOSES ONLY

NOTES
 This sheet shall be used with the Temporary Traffic Control General Notes Sheets TTC-00(A), TTC-00(B), TTC-00(C), and other Temporary Traffic Control Sheets as appropriate.

LEGEND
 [Symbol] Traffic Sign
 [Arrow] Direction of Travel

- This layout represents the minimum traffic controls required for placement of "Road Work Next XX Miles" and "End Road Work" signs.
- This layout does not replace other TTC Standard Sheets, but is intended as a supplement to the required signing.
- The "Road Work Next XX Miles" sign shall be required on all projects. The distance on the "Road Work Next XX Miles" sign shall be stated to the nearest whole mile. This sign shall be placed at the Beginning of Project (B.O.P.) limits.
- The "Road Work Next XX Miles" sign shall be a minimum of 60 inches by 36 inches for all multi-lane roadways and a minimum of 48 inches by 24 inches for two-lane roadways unless otherwise noted.
- The "End Road Work" sign shall be placed 500 feet past the End of Project (E.O.P.) limits.
- If "Road Work Ahead" sign is used on a cross road to warn of road work on another route, then "End Road Work" sign is not required.
- When projects are separated by less than 1 mile, they shall be signed as one project; this may require coordination.

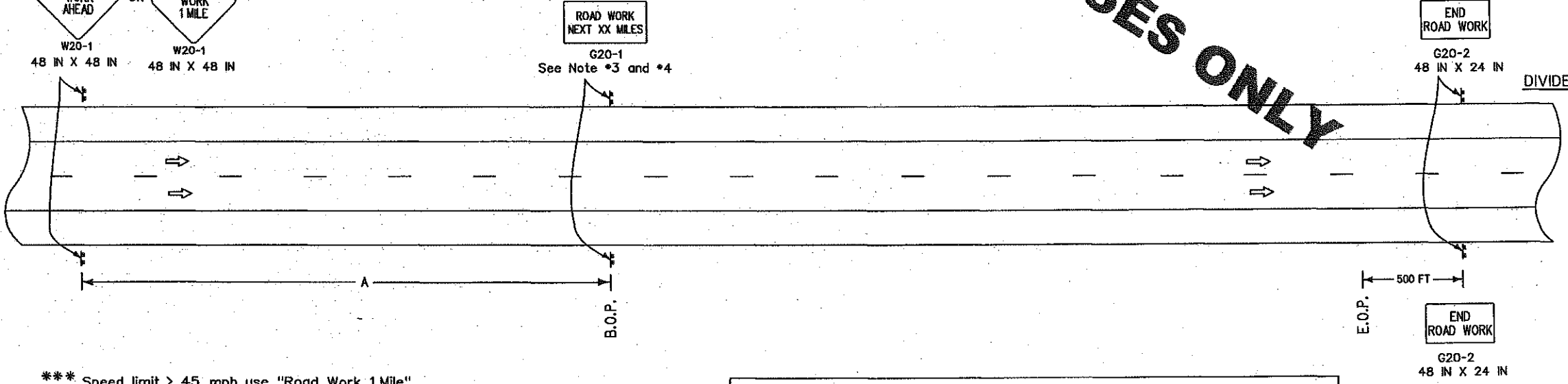
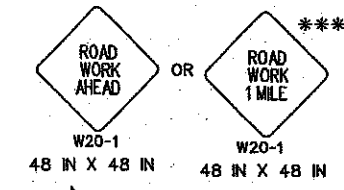

*** Speed limit > 45 mph use "Road Work 1 Mile"
 Speed limit ≤ 45 mph use "Road Work Ahead"

ALL TTC STANDARDS SHOW MINIMUM CONSTRUCTION SIGNING.
 ALL SITUATIONS SHALL BE REVIEWED AND/OR DESIGNED BY THE ENGINEER.
 CONTRACTORS ARE RESPONSIBLE FOR COMPLYING WITH ALL TTC STANDARDS.

SPEED LIMIT (prior to construction)	SPACING 'A'
≤ 40 mph	1500 FT
45 mph	2640 FT
> 45 mph	5280 FT

• Sign spacing to be adjusted for Horizontal and Vertical curves.
 • For work outside of the traveled way, see TTC-01 and TTC-02.

SEE TTC-00(A), TTC-00(B) AND TTC-00(C)

TWO-WAY ROADWAY

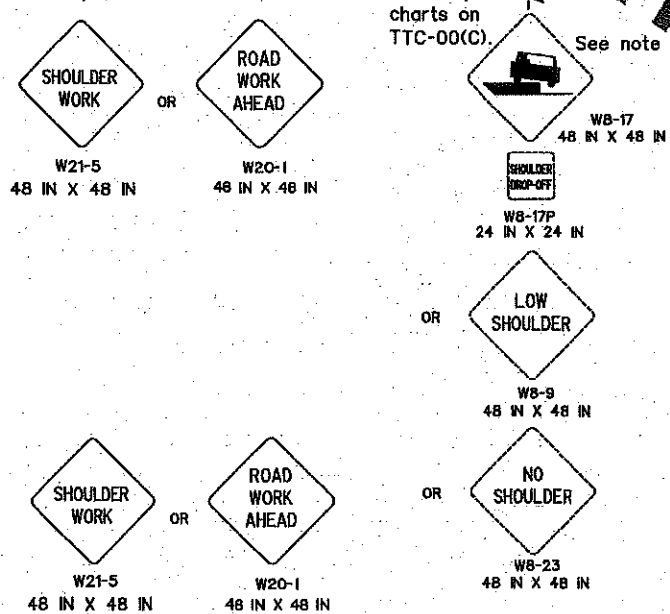
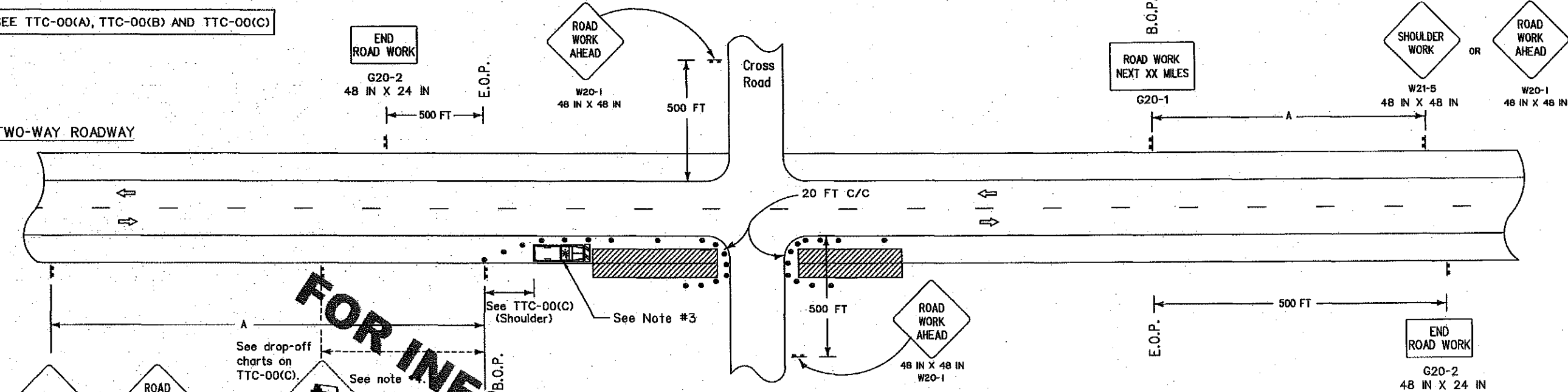

NOTES

This sheet shall be used with the Temporary Traffic Control General Notes Sheets TTC-00(A), TTC-00(B) and TTC-00(C).

1. This layout represents the minimum traffic controls required for workers and equipment operating less than 15 feet from the traveled way for more than one hour. Less than one hour, see figure TA-4 of the MUTCD.
2. No signs or barricades are required for equipment operating or work in progress greater than 15 feet from the traveled way. (See TTC-00(C)).
3. Work or equipment confined to a spot location (less than 20 feet) shall be marked by channelizing devices spaced at 25 feet or by a vehicle with an amber light visible to traffic. Work extending more than 200 feet of roadway length shall be marked with appropriate devices spaced as noted on TTC-00(C).
4. Applicable drop-off sign options are defined on TTC-00(C).

SPEED LIMIT (prior to construction)	SPACING	
	'A'	'B'
≤ 40 mph	500 FT	250 FT
45-50 mph	1000 FT	350 FT
≥ 55 mph	1500 FT	500 FT

- See TTC-00(C) for minimum taper length and maximum device spacing for shoulder closure tapers.
- If horizontal curve radius is less than 300 feet, device spacing shall be 25 feet.

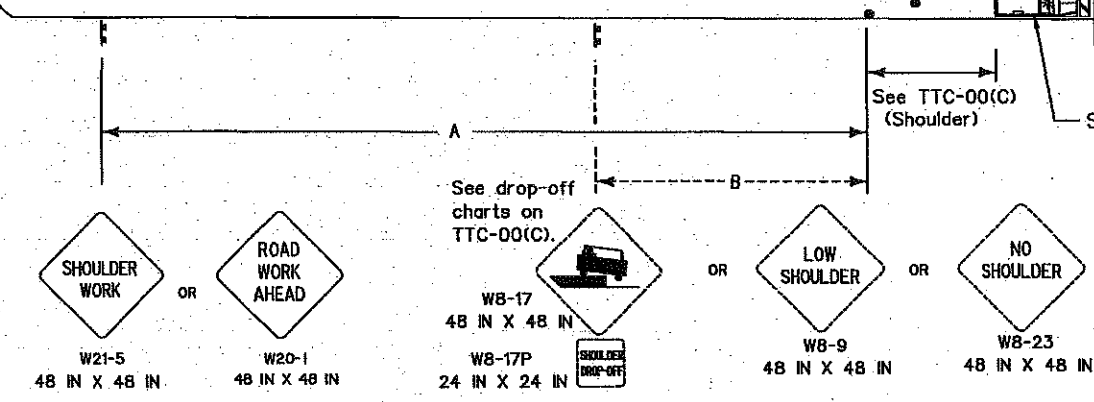
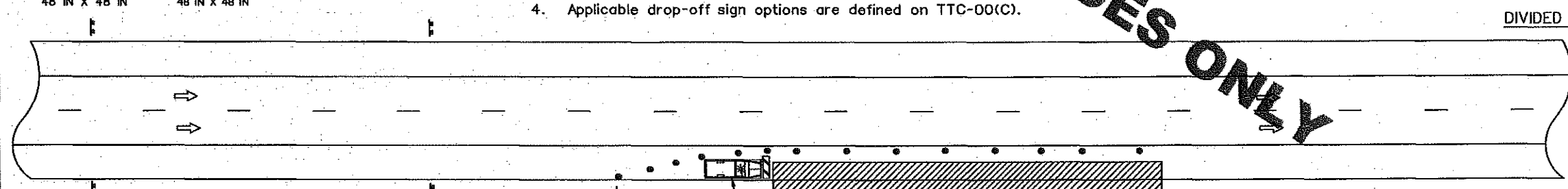

LEGEND

- Traffic Sign
- Channelizing Devices
- Type III Barricades
- Work Area
- Direction of Travel
- Truck with Amber Light

ALL TTC STANDARDS SHOW MINIMUM CONSTRUCTION SIGNING.
ALL SITUATIONS SHALL BE REVIEWED AND/OR DESIGNED BY THE ENGINEER.
CONTRACTORS ARE RESPONSIBLE FOR COMPLYING WITH ALL TTC STANDARDS.

FOR INFORMATIONAL PURPOSES ONLY

SHEET NUMBER	34	DATE	7.1.13	BY	[Signature]
DESIGNED	J. COLVIN	CHECKED	P. ALLAIN	DATE	02/13/2013
REVISION DESCRIPTION	[Blank]				
APPROVED BY	[Signature]				
CHIEF ENGINEER	[Signature]				
TEMPORARY TRAFFIC CONTROL LAYOUT FOR WORK LESS THAN 15 FEET FROM THE TRAVELED WAY					
TTC-02					
TRAFFIC ENGINEERING					

SEE TTC-00(A), TTC-00(B), TTC-00(C), AND TTC-00(D)

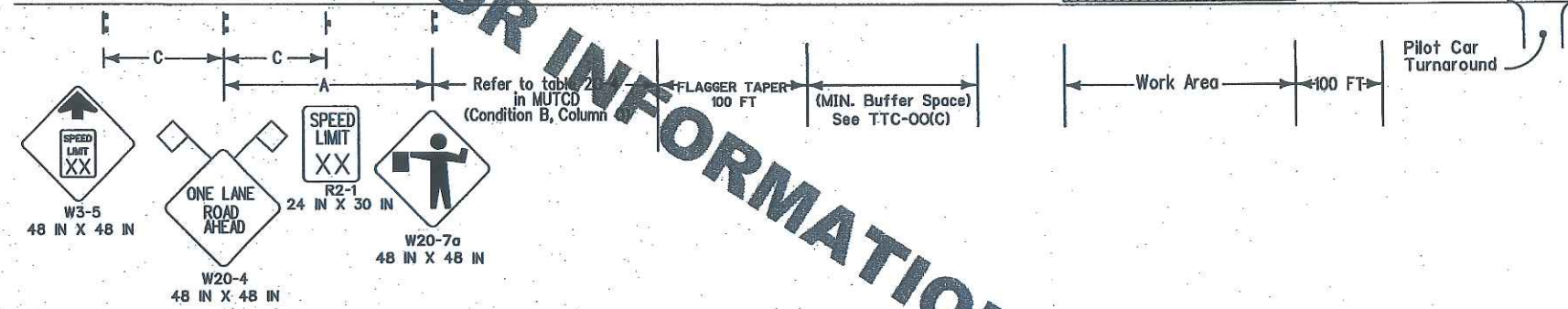
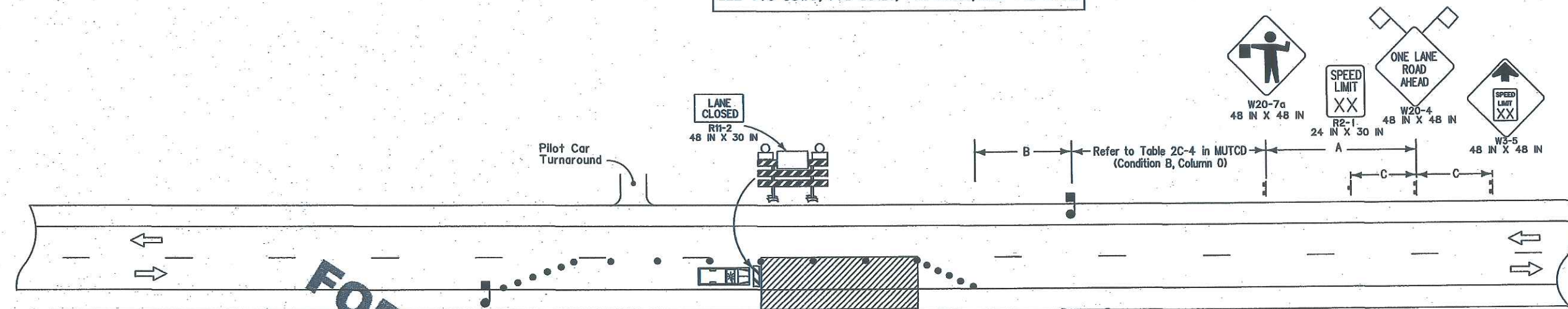

FOR INFORMATIONAL PURPOSES ONLY

NOTES

This sheet shall be used with the Temporary Traffic Control General Notes Sheets TTC-00(A), TTC-00(B), TTC-00(C) and TTC-00(D).

1. This layout represents the minimum traffic controls required for lane closures on two-lane roads with two-way traffic greater than 1600 feet from an intersection. For this type of closure either a flagger or a pilot car will be required. For advance signing see TTC-00(D).
2. To prevent vehicles from entering the work area against the flow of traffic, an additional flagger shall be stationed at each intersection, major driveway, railroad crossing, or crossing within the work area.
3. For projects in rural areas the distance between flaggers shall not exceed:
 - (A) 2.5 miles for ADT < 2,500
 - (B) 2.0 miles for 2,500 < ADT < 5,000
 - (C) 1.5 miles for ADT > 5,000
4. The flagger station shall be near the beginning of the taper and shall have adequate sight distance to be visible to oncoming traffic. If sight distance cannot be achieved, the distance between flaggers may be extended for a short duration.
5. Visual or radio contact shall be required between flaggers at all times. The flagger shall be visible from the flagger sign.

6. If a pilot car is required, then the contractor is not required to have channelizing devices in the danger section.
7. If work zone is less than 1600 feet from an intersection see TTC-03.

PILOT CAR

- If used, a pilot car shall guide a queue of vehicles through the work zone or diversion.
- It shall be used in restricted visibility operations such as lime or cement stabilization, chip seals, or operations in hilly or curvy terrains, where flaggers cannot see each other (no clear line-of-sight).
- The operation of the pilot vehicle shall be coordinated with flagging operations or other controls at each end of the one-lane section and all major driveways and street intersections.
- The pilot car sign should be mounted 7 feet above roadway in a position visible to oncoming and following traffic.
- The pilot car shall have an amber beacon light.
- The sign mounted on the vehicle shall be two-sided.

PILOT CAR
G20-4
36 IN X 18 IN
FRONT OF SIGN

PILOT CAR FOLLOW ME
G20-4
36 IN X 18 IN
(BACK OF SIGN)

SPEED LIMIT (prior to construction)	SPACING		
	'A'	'B'	'C'
≤ 40 mph	500 FT	250 FT	N/A
45-50 mph	1000 FT	360 FT	500 FT
≥ 55 mph	1500 FT	495 FT	800 FT

Sign spacing to be adjusted for Horizontal and Vertical curves.

LEGEND

- Traffic Sign
- Flagger
- Channelizing Devices
- Type III Barricades
- Work Area
- Type B Light
- Direction of Travel
- Truck with Amber Light

ALL TTC STANDARDS SHOW MINIMUM CONSTRUCTION SIGNING.
ALL SITUATIONS SHALL BE REVIEWED AND/OR DESIGNED BY THE ENGINEER.
CONTRACTORS ARE RESPONSIBLE FOR COMPLYING WITH ALL TTC STANDARDS.

SHEET NUMBER 35

DESIGNED BY J. COLVIN
CHECKED BY P. ALLAIN
REVISION DESCRIPTION: REVISION DATE: 02/13/2015
DATE 7/1/17
DATE 7/1/17

TEMPORARY TRAFFIC CONTROL LAYOUT FOR LANE CLOSURES ON TWO LANE ROADS WITH TWO-WAY TRAFFIC (FLAGGING OPERATIONS)

TTC-04

TRAFFIC ENGINEERING

SEDIMENT DELIVERY PIPELINE

PIPE SIZE
CONTENTS

CONTACT: CONTRACTOR
PHONE NUMBER
STREET ADDRESS
CITY, STATE, ZIP CODE

TEMPORARY PIPELINE MARKER DETAIL
(NOT TO SCALE)

51 INCH SEDIMENT DELIVERY CONCRETE CASING PIPE

PROPERTY OF LOUISIANA COASTAL PROTECTION AND RESTORATION AUTHORITY

CONTACT CAMERON PARISH POLICE JURY
(337) 775-5718
148 SMITH CIRCLE
CAMERON, LA. 70631

CASING PIPE MARKER DETAIL
(NOT TO SCALE)

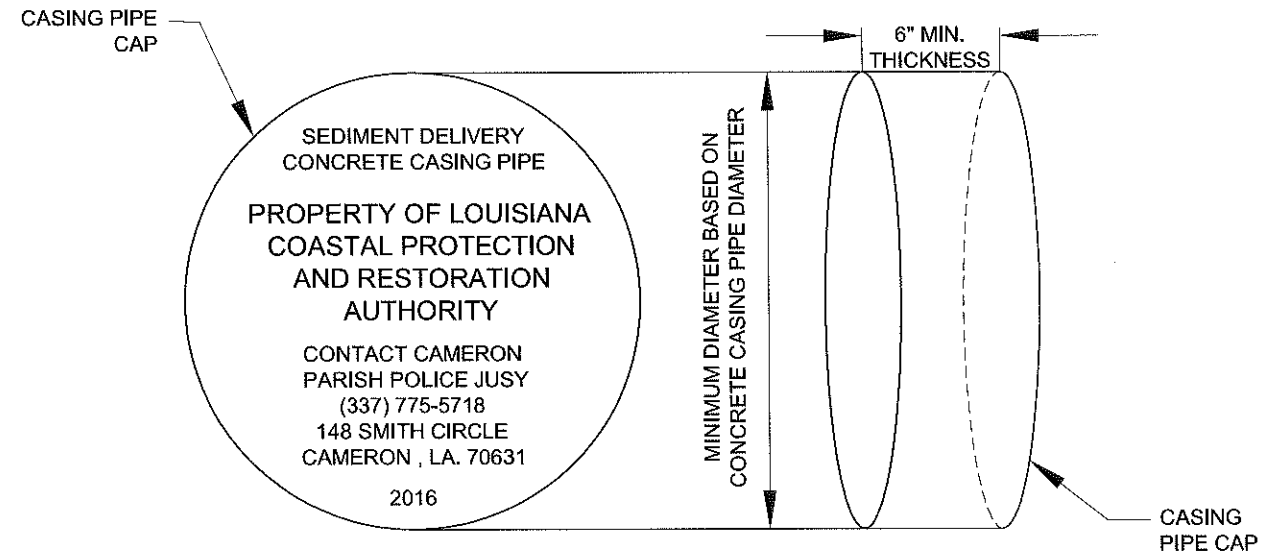

CASING PIPE CAP DETAIL
(NOT TO SCALE)

CASING PIPE CAP NOTES:

1. CAPS SHALL BE INSTALLED IN ACCORDANCE WITH THE SPECIFICATIONS.
2. SEE TS-10 FOR CASING PIPE CAP DETAILS.

TEMPORARY PIPELINE MARKER NOTES:

1. MARKERS SHALL BE CONSTRUCTED AND INSTALLED IN ACCORDANCE WITH LADOTD 2006 STANDARD SPECIFICATION 729.
2. PROPOSED DRAWING SHALL BE SUBMITTED TO THE ENGINEER FOR APPROVAL IN THE WORK PLAN PRIOR TO CONSTRUCTION.
3. MARKERS SHALL BE PLACED PRIOR TO SEDIMENT PIPELINE INSTALLATION AND REMOVED FOLLOWING SEDIMENT PIPELINE REMOVAL.
4. SEE TS-13 FOR TEMPORARY PIPELINE MARKER DETAILS.

CASING PIPE MARKER NOTES:

1. CASING PIPE MARKERS SHALL BE INSTALLED IN ACCORDANCE WITH LADOTD 2006 STANDARD SPECIFICATION 729.
2. PROPOSED DRAWING SHALL BE SUBMITTED TO THE ENGINEER FOR APPROVAL IN THE WORK PLAN PRIOR TO CONSTRUCTION.
3. MARKERS SHALL BE REPLACED SUBSEQUENT TO BACKFILLING THE PIT AND PRIOR TO DEMOBILIZATION.
4. SEE TS-10 FOR CASING PIPE MARKER DETAILS.

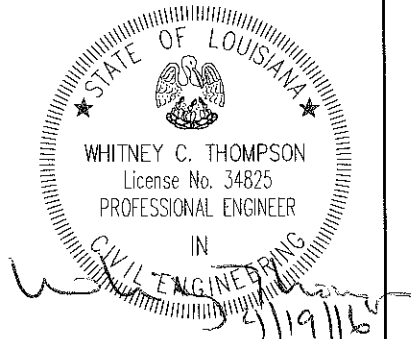

REV.	DATE	DESCRIPTION	BY	CB&I COASTAL PLANNING & ENGINEERING, INC. 2481 N.W. BOCA RATON BOULEVARD BOCA RATON, FLORIDA 33431 PH. (561) 391-8102 FAX (561) 391-8116 C.O.A. FL. #4028 C.O.A. LA. #2531 www.CBI.COM	COASTAL PROTECTION AND RESTORATION AUTHORITY 450 LAUREL STREET BATON ROUGE, LOUISIANA 70801	OYSTER BAYOU MARSH RESTORATION PROJECT		TEMPORARY PIPELINE MARKER AND CASING PIPE CAP/MARKER DETAIL DATE: APRIL 13, 2016 SHEET 36 OF 69
						STATE PROJECT NUMBER: CS-59		
						FEDERAL PROJECT NUMBER: CS-59		
						APPROVED BY: WT		
				DRAWN BY: GK	DESIGNED BY: CP			

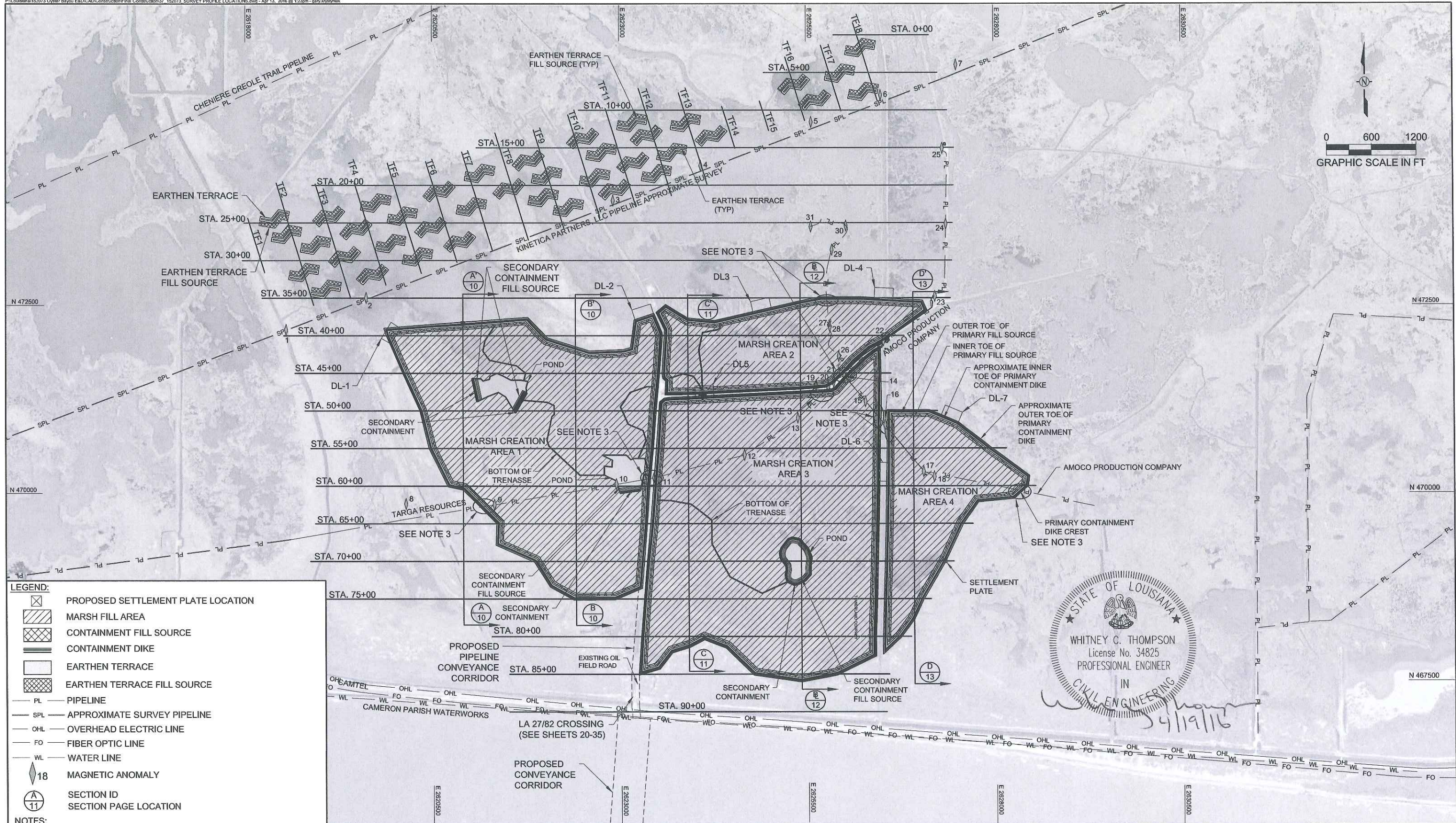

LEGEND:

- PROPOSED SETTLEMENT PLATE LOCATION
- MARSH FILL AREA
- CONTAINMENT FILL SOURCE
- CONTAINMENT DIKE
- EARTHEN TERRACE
- EARTHEN TERRACE FILL SOURCE
- PIPELINE
- APPROXIMATE SURVEY PIPELINE
- OVERHEAD ELECTRIC LINE
- FIBER OPTIC LINE
- WATER LINE
- MAGNETIC ANOMALY
- SECTION ID
- SECTION PAGE LOCATION

NOTES:

- COORDINATES ARE IN FEET BASED ON LOUISIANA STATE PLANE COORDINATE SYSTEM, SOUTH ZONE, NORTH AMERICAN DATUM OF 1983 (NAD83).
- DATE OF AERIAL IMAGERY: 2013.
- CONTRACTOR SHALL AVOID EXCAVATION WITHIN 50' OF PIPELINES.
- SURVEY PROFILE COODINATES ARE SHOWN ON SHEET 4.

REV.	DATE	DESCRIPTION	BY

CB&I COASTAL PLANNING & ENGINEERING, INC.
 2481 N.W. BOCA RATON BOULEVARD
 BOCA RATON, FLORIDA 33431
 PH. (561) 391-8102
 FAX (561) 391-9116
 C.O.A. FL. #4028
 C.O.A. LA. #2531
 www.CBI.COM

COASTAL PROTECTION AND RESTORATION AUTHORITY
 450 LAUREL STREET
 BATON ROUGE, LOUISIANA 70801
 DRAWN BY: GK
 DESIGNED BY: CP

OYSTER BAYOU MARSH RESTORATION PROJECT
 STATE PROJECT NUMBER: CS-59
 FEDERAL PROJECT NUMBER: CS-59
 APPROVED BY: WT

SURVEY PROFILE LOCATIONS
 DATE: APRIL 13, 2016
 SHEET 37 OF 69

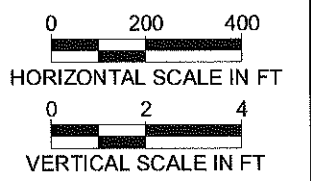
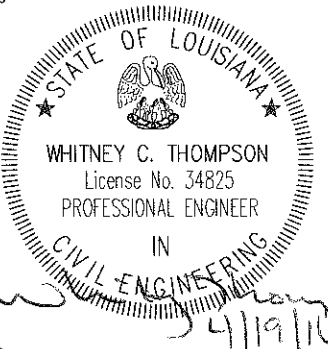
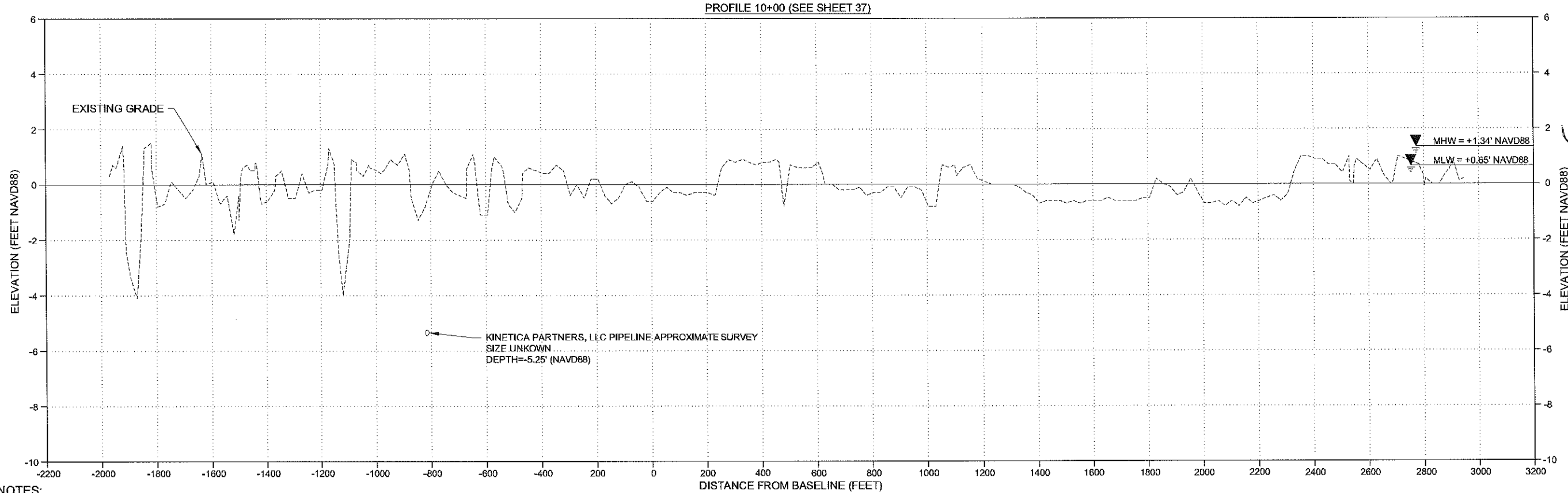
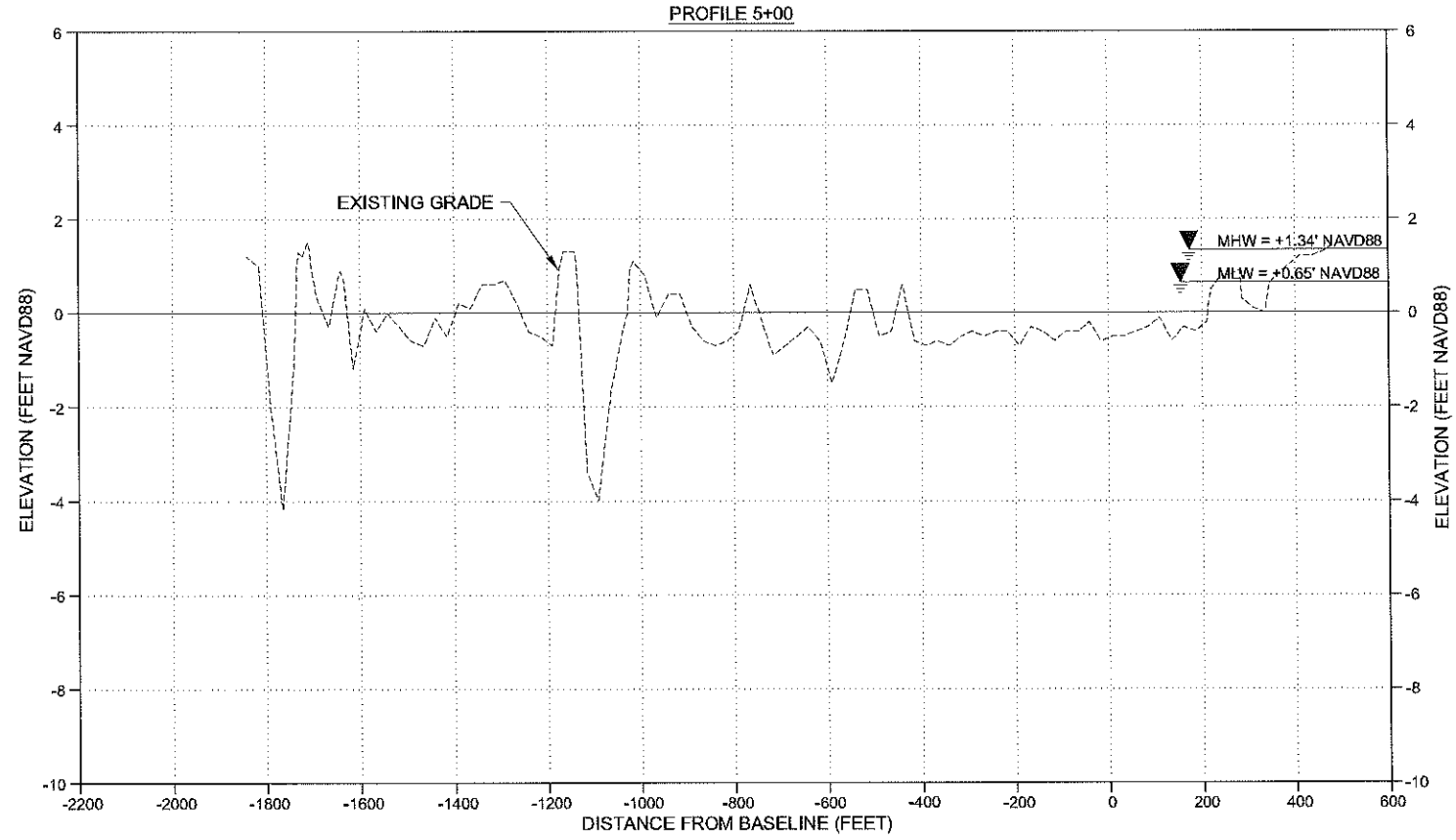
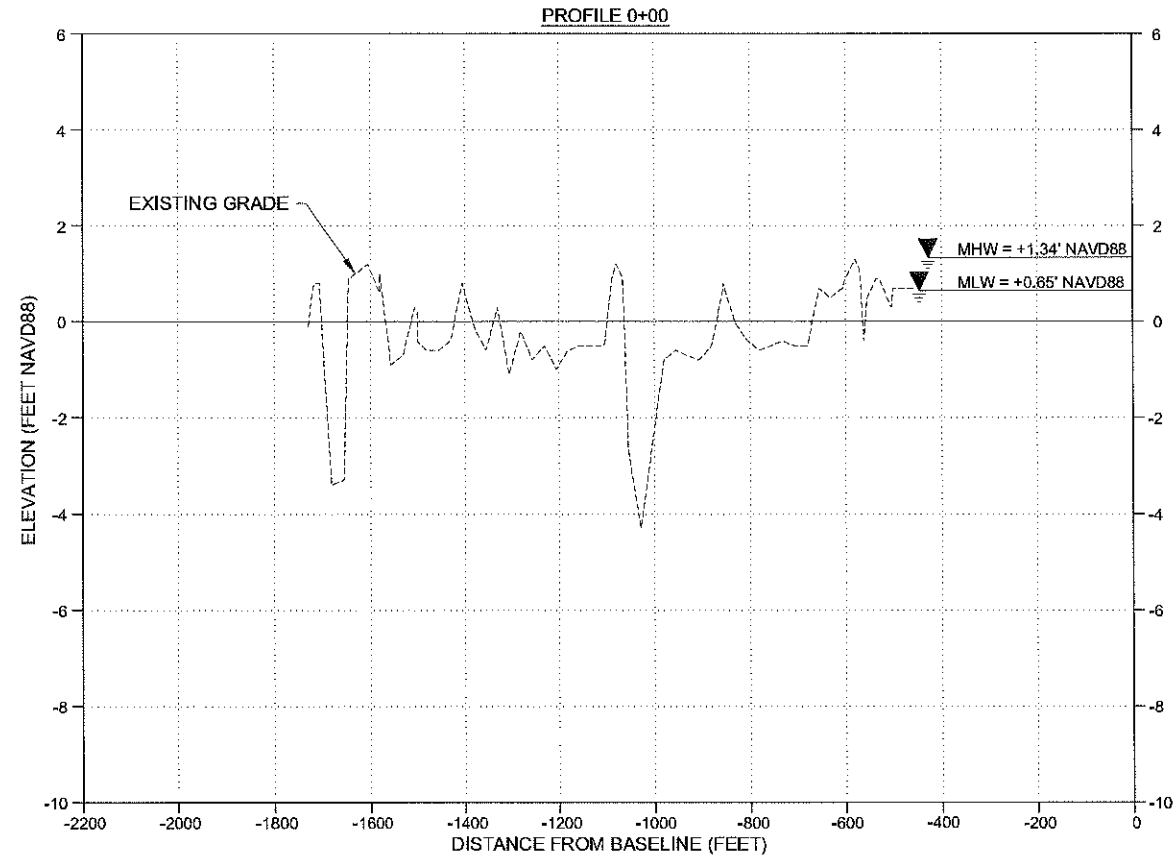

NOTES:

- ELEVATIONS SHOWN HEREON ARE IN FEET BASED ON NAVD 1988.
- SURVEY ELEVATIONS SHOWN ON THE PLANS ARE FROM SURVEY DATA COLLECTED IN AUGUST AND SEPTEMBER 2012 BY LONNIE G. HARPER AND ASSOCIATES.
- LAYOUT ALL FILL AREAS BY CROSS SECTIONS.
- POSITIVE RANGES ARE WEST OF BASELINE. NEGATIVE RANGES ARE EAST OF BASELINE. (PROFILES LOOKING SOUTH)
- LOCATIONS OF PIPELINES ARE APPROXIMATE. CONTRACTOR SHALL VERIFY EXACT LOCATION PRIOR TO EXCAVATION.
- NO EXCAVATION IS ALLOWED WITHIN 50 FEET OF A PIPELINE.

REV.	DATE	DESCRIPTION	BY

CB&I COASTAL PLANNING & ENGINEERING, INC.
2481 N.W. BOCA RATON BOULEVARD
BOCA RATON, FLORIDA 33431

PH. (561) 391-8102
FAX (561) 391-9116

C.O.A. FL. #4028
C.O.A. LA. #2531
www.CBI.COM

COASTAL PROTECTION AND RESTORATION AUTHORITY
450 LAUREL STREET
BATON ROUGE, LOUISIANA 70801

DRAWN BY: GK
DESIGNED BY: CP

OYSTER BAYOU MARSH RESTORATION PROJECT

STATE PROJECT NUMBER: CS-59
FEDERAL PROJECT NUMBER: CS-59

APPROVED BY: WT

EXISTING CONDITIONS PROFILES

DATE: APRIL 13, 2016
SHEET 38 OF 69

PROFILE 15+00 (SEE SHEET 37)

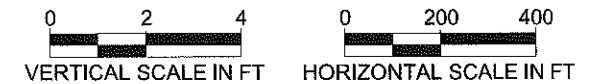
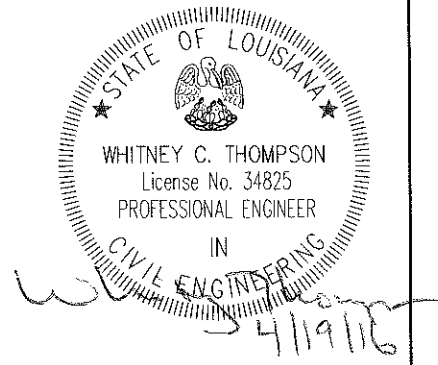
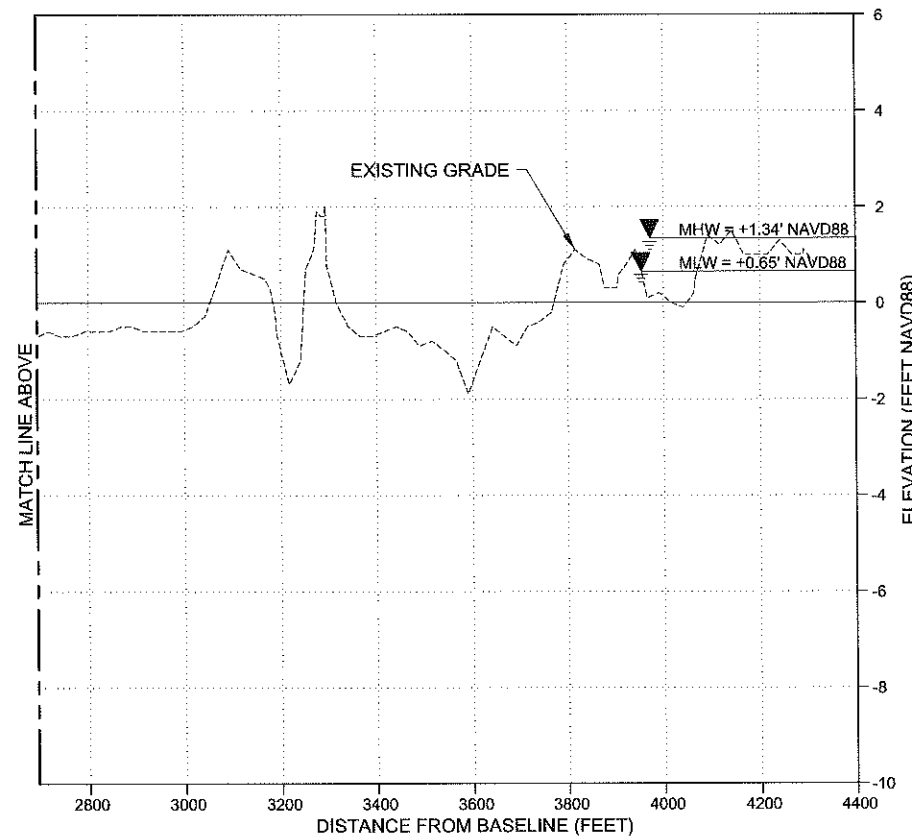
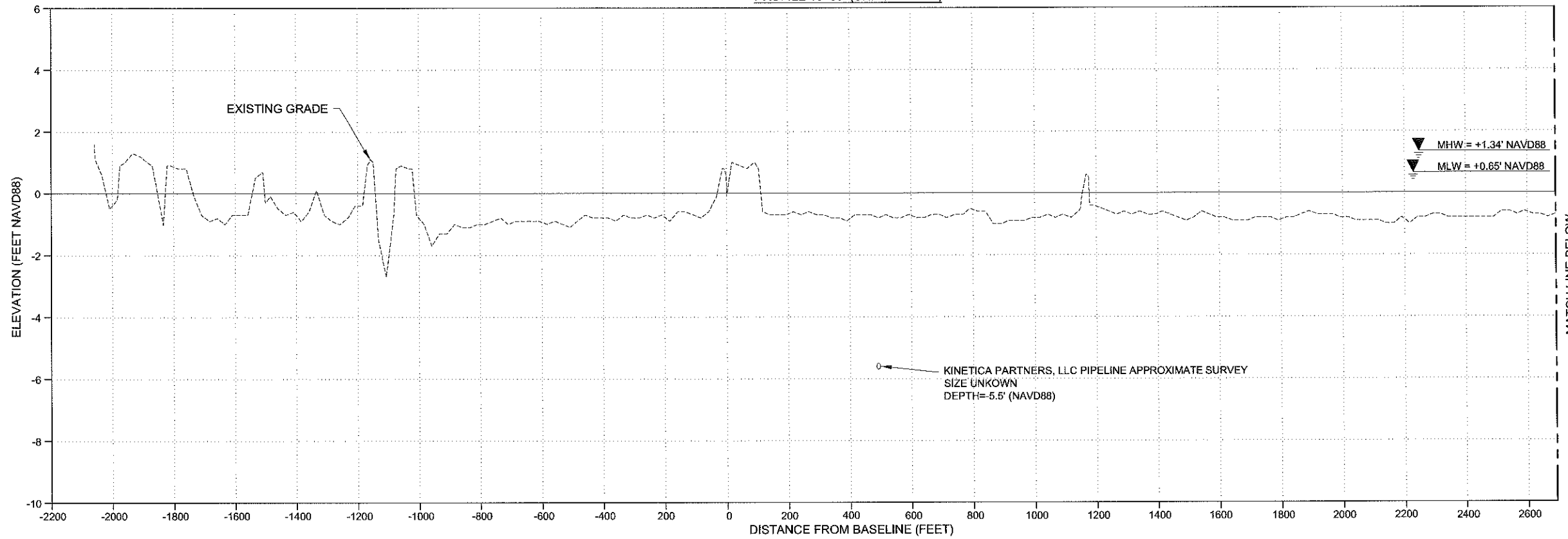

NOTES:

1. ELEVATIONS SHOWN HEREON ARE IN FEET BASED ON NAVD 1988.
2. SURVEY ELEVATIONS SHOWN ON THE PLANS ARE FROM SURVEY DATA COLLECTED IN AUGUST AND SEPTEMBER 2012 BY LONNIE G. HARPER AND ASSOCIATES.
3. LAYOUT ALL FILL AREAS BY CROSS SECTIONS.
4. POSITIVE RANGES ARE WEST OF BASELINE. NEGATIVE RANGES ARE EAST OF BASELINE.
5. LOCATIONS OF PIPELINES ARE APPROXIMATE. CONTRACTOR SHALL VERIFY EXACT LOCATION PRIOR TO EXCAVATION.
6. NO EXCAVATION IS ALLOWED WITHIN 50 FEET OF A PIPELINE.

REV.	DATE	DESCRIPTION	BY

CB&I COASTAL PLANNING & ENGINEERING, INC.

2481 N.W. BOCA RATON BOULEVARD
BOCA RATON, FLORIDA 33431

PH. (561) 391-8102
FAX (561) 391-8116

C.O.A. FL #4028
C.O.A. LA #2531
www.CBI.COM

COASTAL PROTECTION AND RESTORATION AUTHORITY

450 LAUREL STREET
BATON ROUGE, LOUISIANA 70801

DRAWN BY: GK

DESIGNED BY: CP

OYSTER BAYOU MARSH RESTORATION PROJECT

STATE PROJECT NUMBER: CS-59

FEDERAL PROJECT NUMBER: CS-59

APPROVED BY: WT

EXISTING CONDITIONS PROFILES

DATE: APRIL 13, 2016

SHEET 39 OF 69

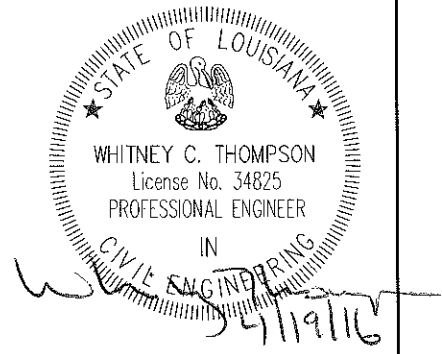
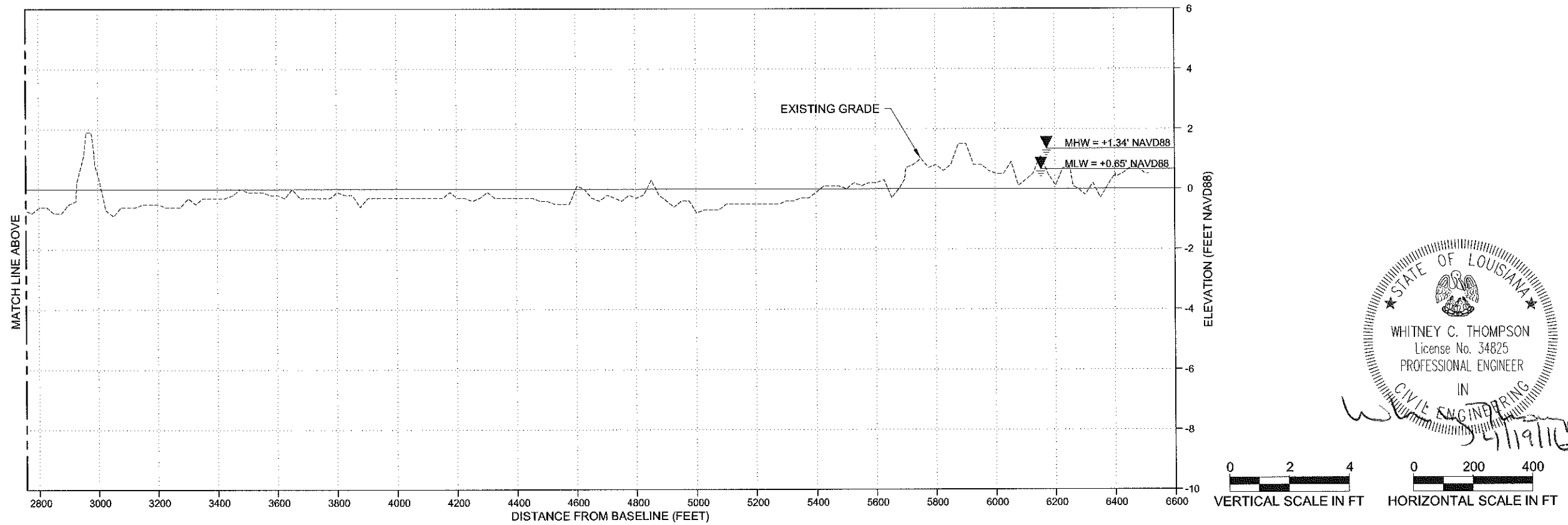
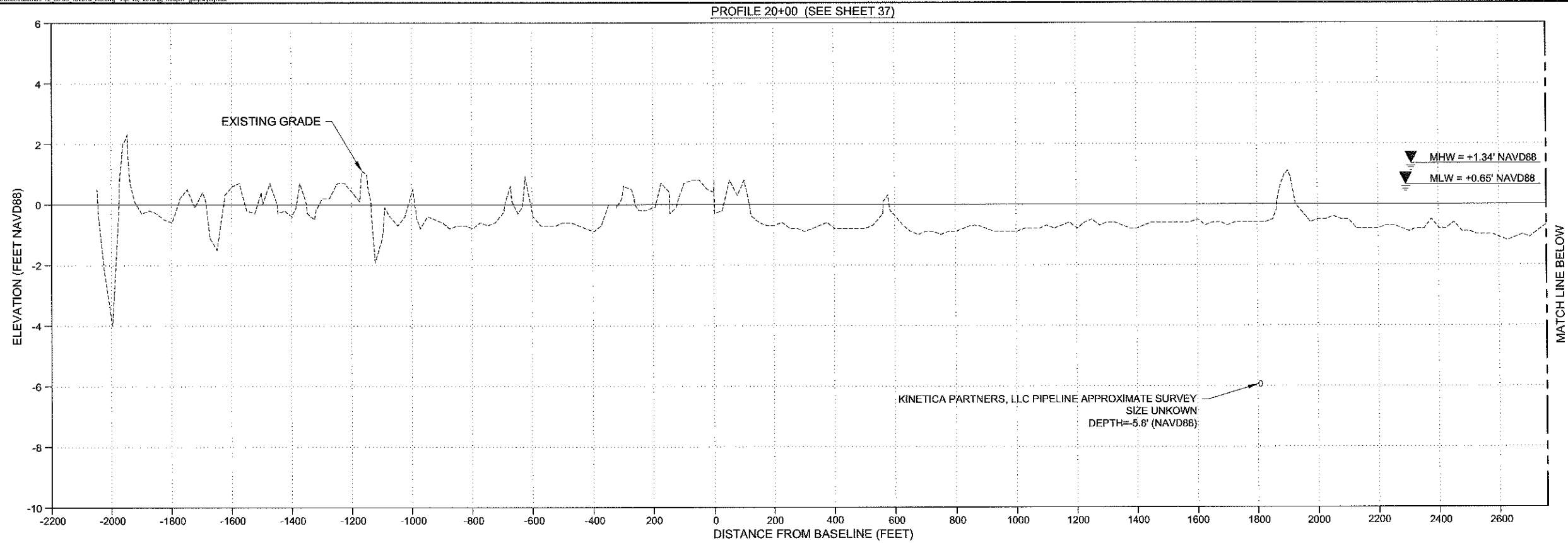

NOTES:

1. ELEVATIONS SHOWN HEREON ARE IN FEET BASED ON NAVD 1988.
2. SURVEY ELEVATIONS SHOWN ON THE PLANS ARE FROM SURVEY DATA COLLECTED IN AUGUST AND SEPTEMBER 2012 BY LONNIE G. HARPER AND ASSOCIATES.
3. LAYOUT ALL FILL AREAS BY CROSS SECTIONS.
4. POSITIVE RANGES ARE WEST OF BASELINE. NEGATIVE RANGES ARE EAST OF BASELINE.
5. LOCATIONS OF PIPELINES ARE APPROXIMATE. CONTRACTOR SHALL VERIFY EXACT LOCATION PRIOR TO EXCAVATION.
6. NO EXCAVATION IS ALLOWED WITHIN 50 FEET OF A PIPELINE.

REV.	DATE	DESCRIPTION	BY

CB&I COASTAL PLANNING & ENGINEERING, INC.

2481 N.W. BOCA RATON BOULEVARD
BOCA RATON, FLORIDA 33431

PH. (561) 391-8102
FAX (561) 391-8116

C.O.A. FL. #4028
C.O.A. LA. #2531
www.CBI.COM

COASTAL PROTECTION AND RESTORATION AUTHORITY

450 LAUREL STREET
BATON ROUGE, LOUISIANA 70801

DRAWN BY: GK

DESIGNED BY: CP

OYSTER BAYOU MARSH RESTORATION PROJECT

STATE PROJECT NUMBER: CS-59

FEDERAL PROJECT NUMBER: CS-59

APPROVED BY: WT

EXISTING CONDITIONS PROFILES

DATE: APRIL 13, 2016

SHEET 40 OF 69

PROFILE 25+00 (SEE SHEET 37)

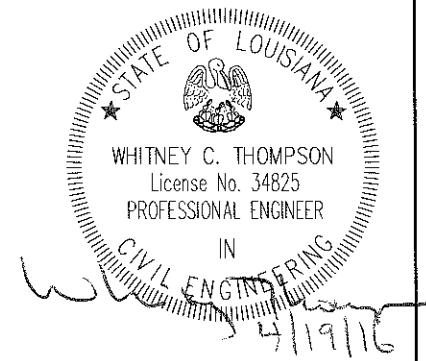
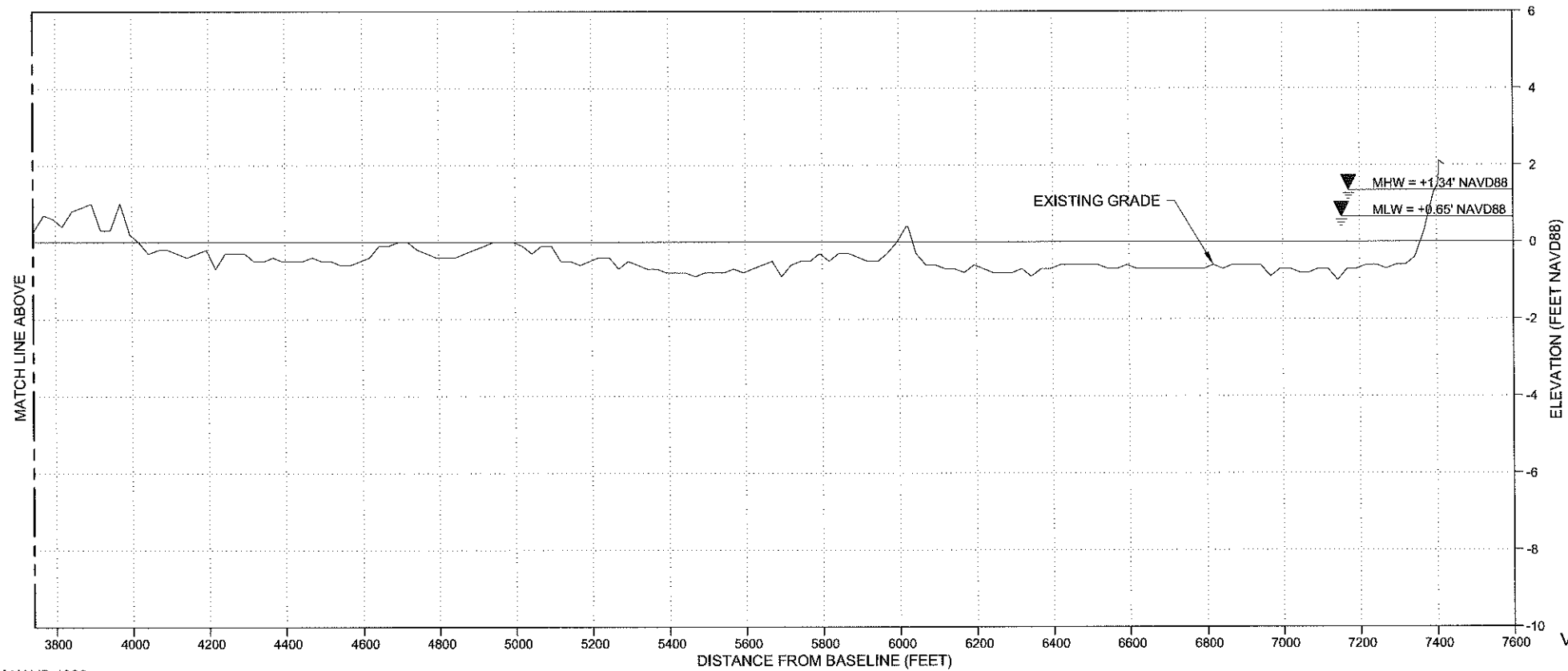
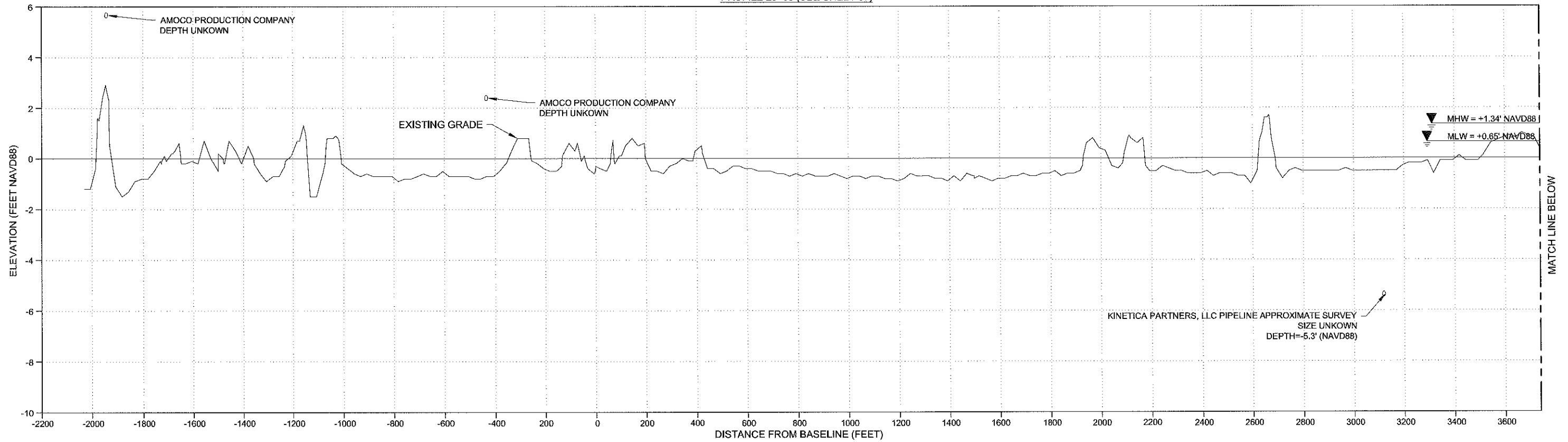

NOTES:

1. ELEVATIONS SHOWN HEREON ARE IN FEET BASED ON NAVD 1988.
2. SURVEY ELEVATIONS SHOWN ON THE PLANS ARE FROM SURVEY DATA COLLECTED IN AUGUST AND SEPTEMBER 2012 BY LONNIE G. HARPER AND ASSOCIATES.
3. LAYOUT ALL FILL AREAS BY CROSS SECTIONS.
4. POSITIVE RANGES ARE WEST OF BASELINE. NEGATIVE RANGES ARE EAST OF BASELINE.
5. LOCATIONS OF PIPELINES ARE APPROXIMATE. CONTRACTOR SHALL VERIFY EXACT LOCATION PRIOR TO EXCAVATION.
6. NO EXCAVATION IS ALLOWED WITHIN 50 FEET OF A PIPELINE.

REV.	DATE	DESCRIPTION	BY

CB&I COASTAL PLANNING & ENGINEERING, INC.
 2481 N.W. BOCA RATON BOULEVARD
 BOCA RATON, FLORIDA 33431
 PH. (561) 391-8102
 FAX (561) 391-8116
 C.O.A. FL. #4028
 C.O.A. LA. #2531
 www.CBI.COM

COASTAL PROTECTION AND RESTORATION AUTHORITY
 450 LAUREL STREET
 BATON ROUGE, LOUISIANA 70801
 DRAWN BY: GK
 DESIGNED BY: CP

OYSTER BAYOU MARSH RESTORATION PROJECT
 STATE PROJECT NUMBER: CS-59
 FEDERAL PROJECT NUMBER: CS-59
 APPROVED BY: WT

EXISTING CONDITIONS PROFILES
 DATE: APRIL 13, 2016
 SHEET 41 OF 69

PROFILE 30+00 (SEE SHEET 37)

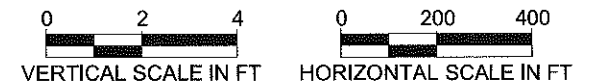
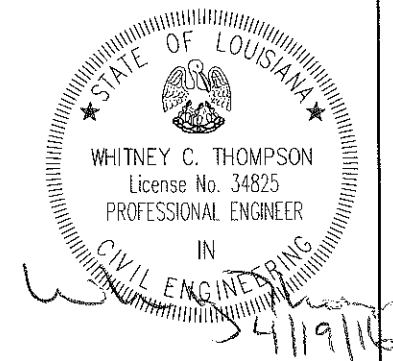
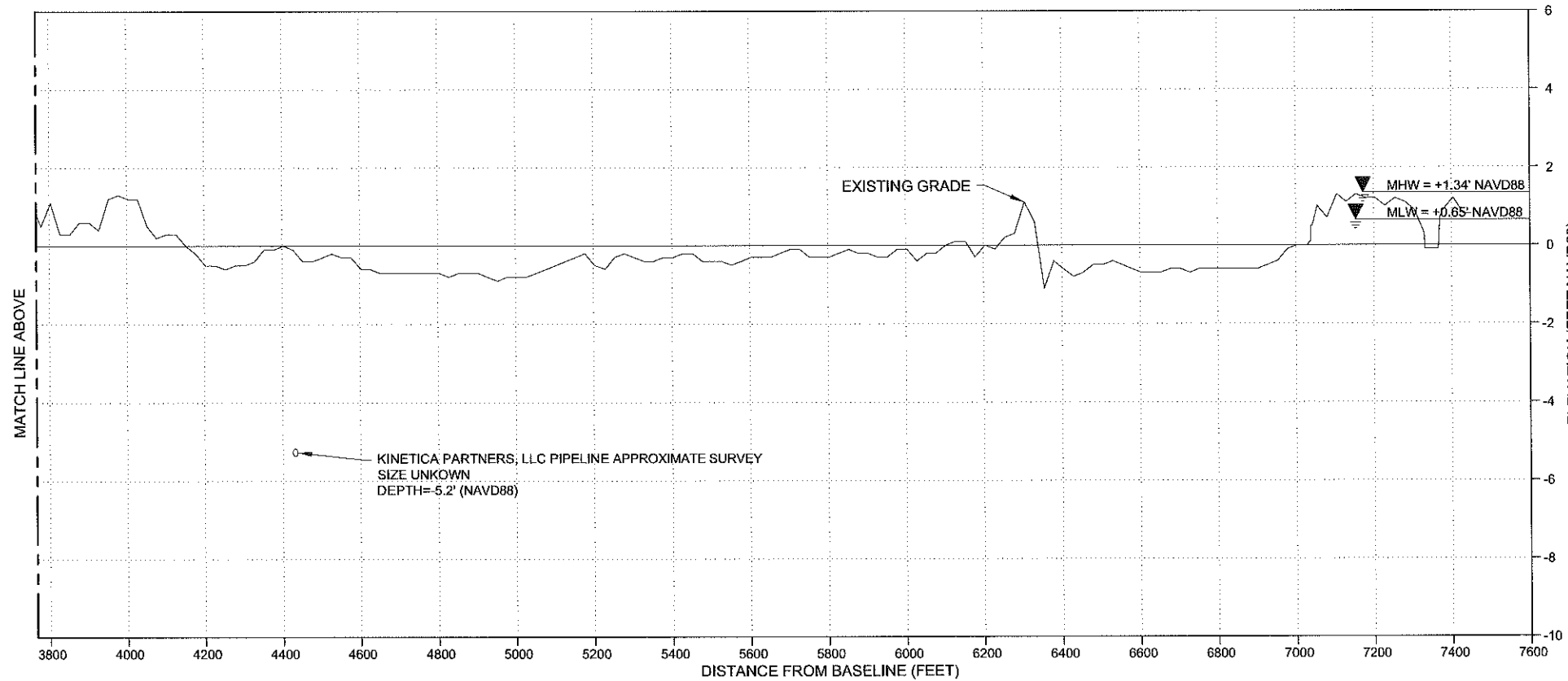
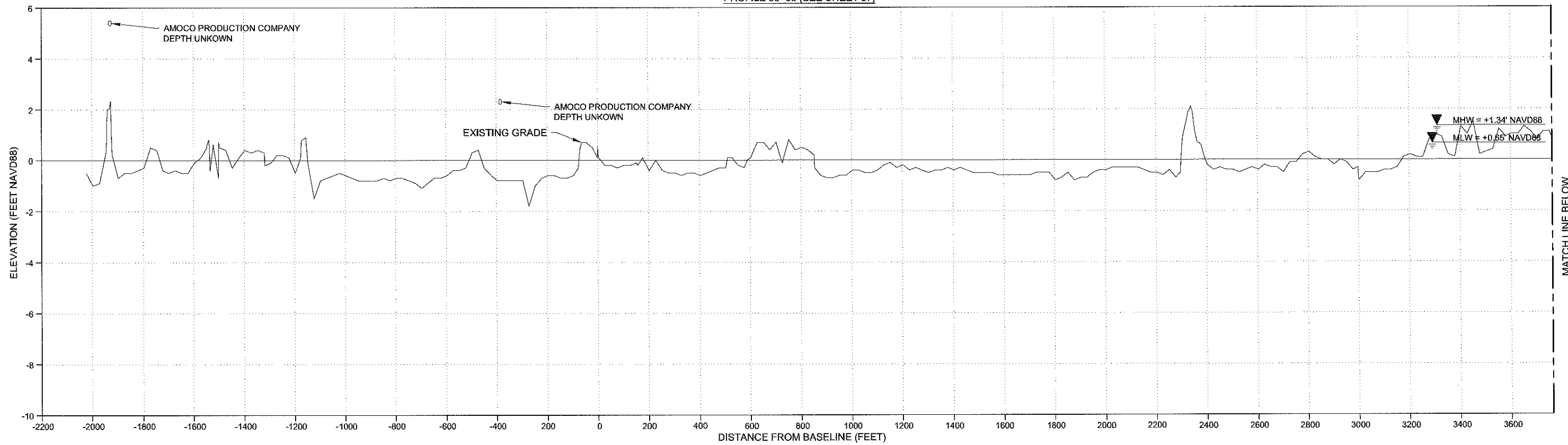

NOTES:

1. ELEVATIONS SHOWN HEREON ARE IN FEET BASED ON NAVD 1988.
2. SURVEY ELEVATIONS SHOWN ON THE PLANS ARE FROM SURVEY DATA COLLECTED IN AUGUST AND SEPTEMBER 2012 BY LONNIE G. HARPER AND ASSOCIATES.
3. LAYOUT ALL FILL AREAS BY CROSS SECTIONS.
4. POSITIVE RANGES ARE WEST OF BASELINE. NEGATIVE RANGES ARE EAST OF BASELINE.
5. LOCATIONS OF PIPELINES ARE APPROXIMATE. CONTRACTOR SHALL VERIFY EXACT LOCATION PRIOR TO EXCAVATION.
6. NO EXCAVATION IS ALLOWED WITHIN 50 FEET OF A PIPELINE.

REV.	DATE	DESCRIPTION	BY

CB&I COASTAL PLANNING & ENGINEERING, INC.

2481 N.W. BOCA RATON BOULEVARD
BOCA RATON, FLORIDA 33431

PH. (561) 391-8102
FAX (561) 391-9116

C.O.A. FL. #4028
C.O.A. LA. #2531
www.CBI.COM

COASTAL PROTECTION AND RESTORATION AUTHORITY

450 LAUREL STREET
BATON ROUGE, LOUISIANA 70801

DRAWN BY: GK

DESIGNED BY: CP

OYSTER BAYOU MARSH RESTORATION PROJECT

STATE PROJECT NUMBER: CS-59

FEDERAL PROJECT NUMBER: CS-59

APPROVED BY: WT

EXISTING CONDITIONS PROFILES

DATE: APRIL 13, 2016

SHEET 42 OF 69

PROFILE 35+00 (SEE SHEET 37)

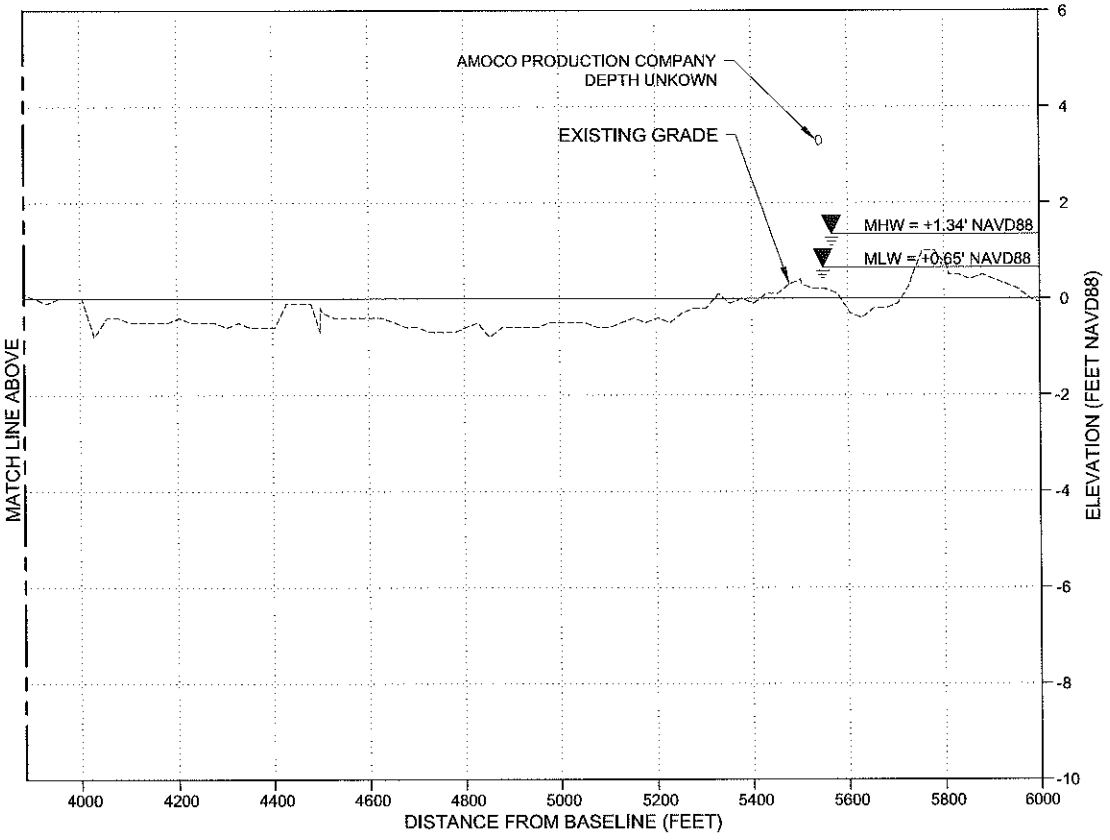
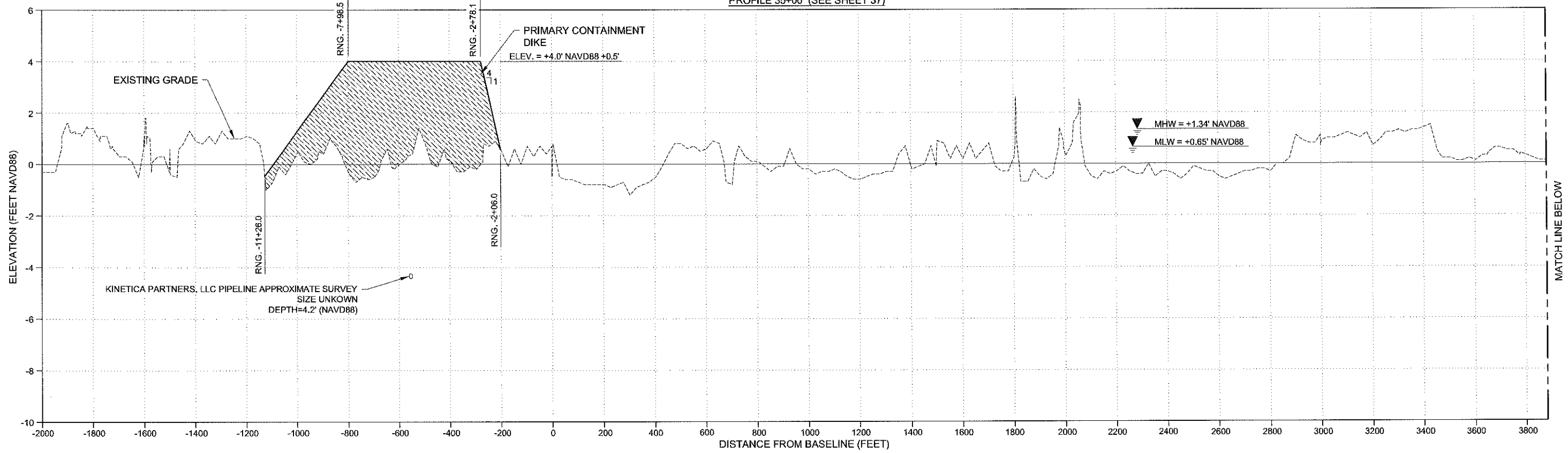

- LEGEND:**
- CONTAINMENT DIKE
 - MARSH FILL
 - FILL SOURCE

- NOTES:**
1. ELEVATIONS SHOWN HEREON ARE IN FEET BASED ON NAVD 1988.
 2. SURVEY ELEVATIONS SHOWN ON THE PLANS ARE FROM SURVEY DATA COLLECTED IN AUGUST AND SEPTEMBER 2012 BY LONNIE G. HARPER AND ASSOCIATES.
 3. LAYOUT ALL FILL AREAS BY CROSS SECTIONS.
 4. POSITIVE RANGES ARE WEST OF BASELINE. NEGATIVE RANGES ARE EAST OF BASELINE.
 5. LOCATIONS OF PIPELINES ARE APPROXIMATE. CONTRACTOR SHALL VERIFY EXACT LOCATION PRIOR TO EXCAVATION.
 6. NO EXCAVATION IS ALLOWED WITHIN 50 FEET OF A PIPELINE.
 7. SEE SHEET 39 FOR CONTAINMENT TYPICAL SECTION.

REV.	DATE	DESCRIPTION	BY

CB&I COASTAL PLANNING & ENGINEERING, INC.
 2481 N.W. BOCA RATON BOULEVARD
 BOCA RATON, FLORIDA 33431
 PH. (561) 391-8102
 FAX (561) 391-8116
 C.O.A. FL. #4028
 C.O.A. LA. #2531
 www.CBI.COM

COASTAL PROTECTION AND RESTORATION AUTHORITY
 450 LAUREL STREET
 BATON ROUGE, LOUISIANA 70801
 DRAWN BY: GK
 DESIGNED BY: CP

OYSTER BAYOU MARSH RESTORATION PROJECT
 STATE PROJECT NUMBER: CS-59
 FEDERAL PROJECT NUMBER: CS-59
 APPROVED BY: WT

MARSH CREATION CONSTRUCTION PROFILES
 DATE: APRIL 13, 2016
 SHEET 43 OF 69

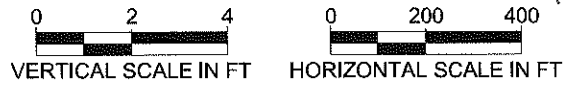
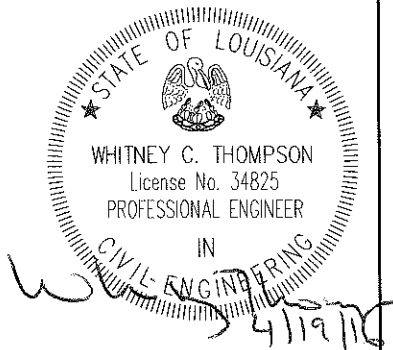

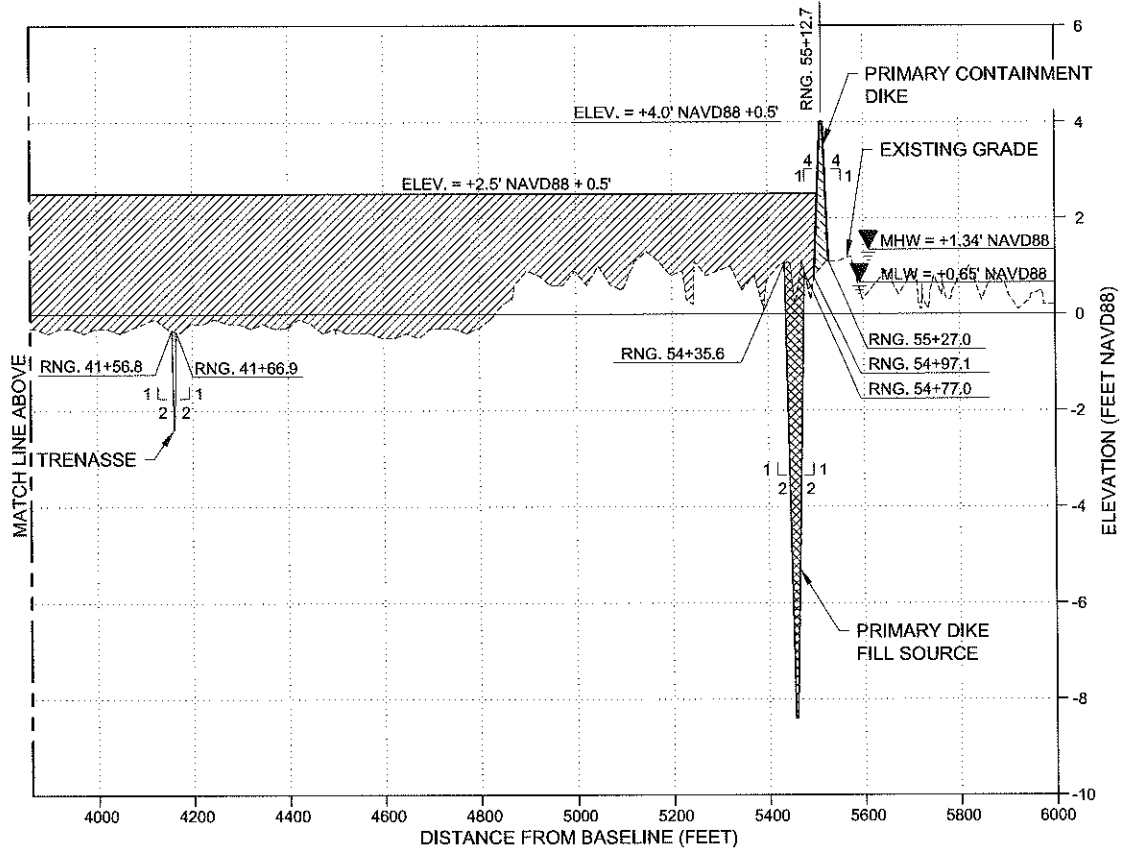
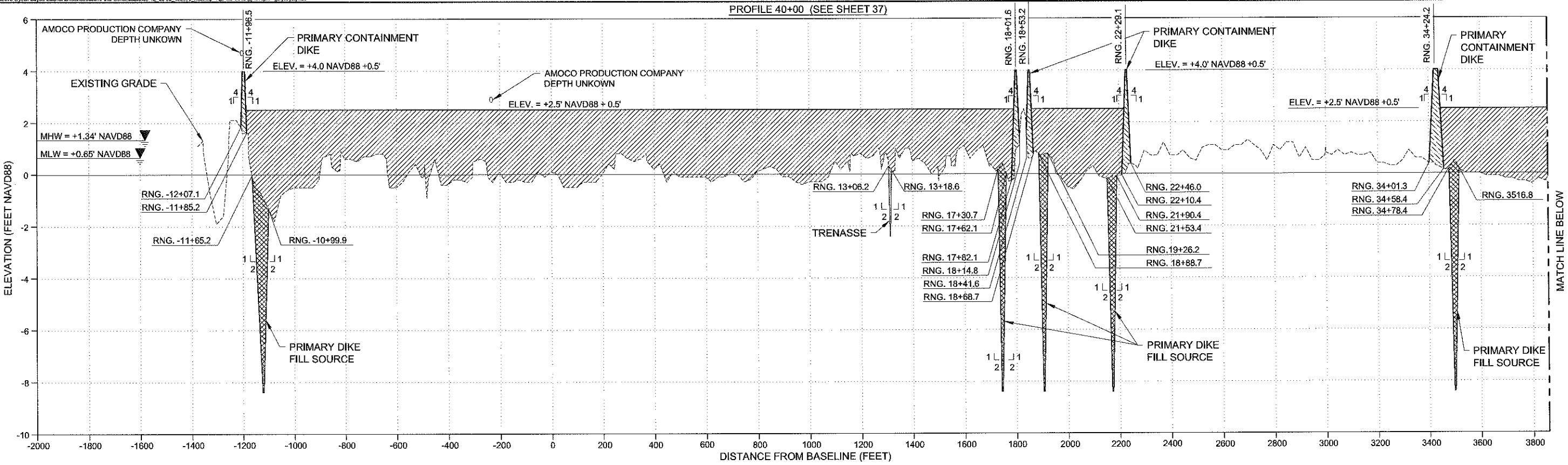

- LEGEND:**
- CONTAINMENT DIKE
 - MARSH FILL
 - FILL SOURCE
 - TRENASSE

- NOTES:**
1. ELEVATIONS SHOWN HEREON ARE IN FEET BASED ON NAVD 1988.
 2. SURVEY ELEVATIONS SHOWN ON THE PLANS ARE FROM SURVEY DATA COLLECTED IN AUGUST AND SEPTEMBER 2012 BY LONNIE G. HARPER AND ASSOCIATES.
 3. LAYOUT ALL FILL AREAS BY CROSS SECTIONS.
 4. POSITIVE RANGES ARE WEST OF BASELINE. NEGATIVE RANGES ARE EAST OF BASELINE.
 5. LOCATIONS OF PIPELINES ARE APPROXIMATE. CONTRACTOR SHALL VERIFY EXACT LOCATION PRIOR TO EXCAVATION.
 6. NO EXCAVATION IS ALLOWED WITHIN 50 FEET OF A PIPELINE.

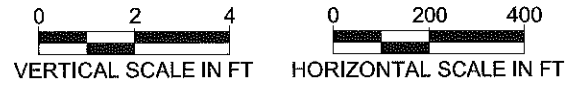
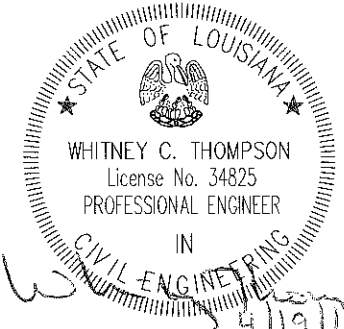

		CB&I COASTAL PLANNING & ENGINEERING, INC. 2481 N.W. BOCA RATON BOULEVARD BOCA RATON, FLORIDA 33431 PH. (561) 391-8102 FAX (561) 391-8116 C.O.A. FL. #4028 C.O.A. LA. #2531 www.CBI.com		COASTAL PROTECTION AND RESTORATION AUTHORITY 450 LAUREL STREET BATON ROUGE, LOUISIANA 70801 DRAWN BY: GK DESIGNED BY: CP		OYSTER BAYOU MARSH RESTORATION PROJECT		MARSH CREATION CONSTRUCTION PROFILES DATE: APRIL 13, 2016 SHEET 44 OF 69	
						STATE PROJECT NUMBER: CS-59 FEDERAL PROJECT NUMBER: CS-59 APPROVED BY: WT			
REV.	DATE	DESCRIPTION	BY						

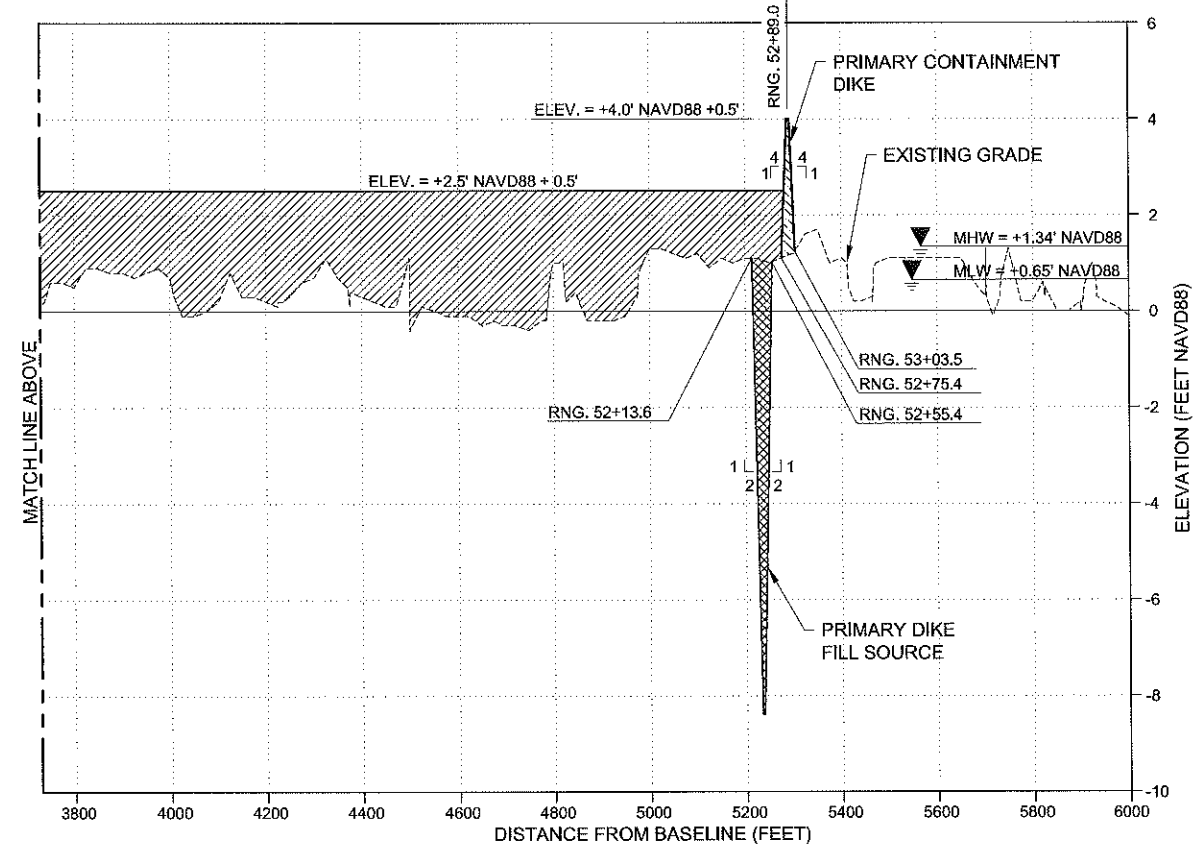
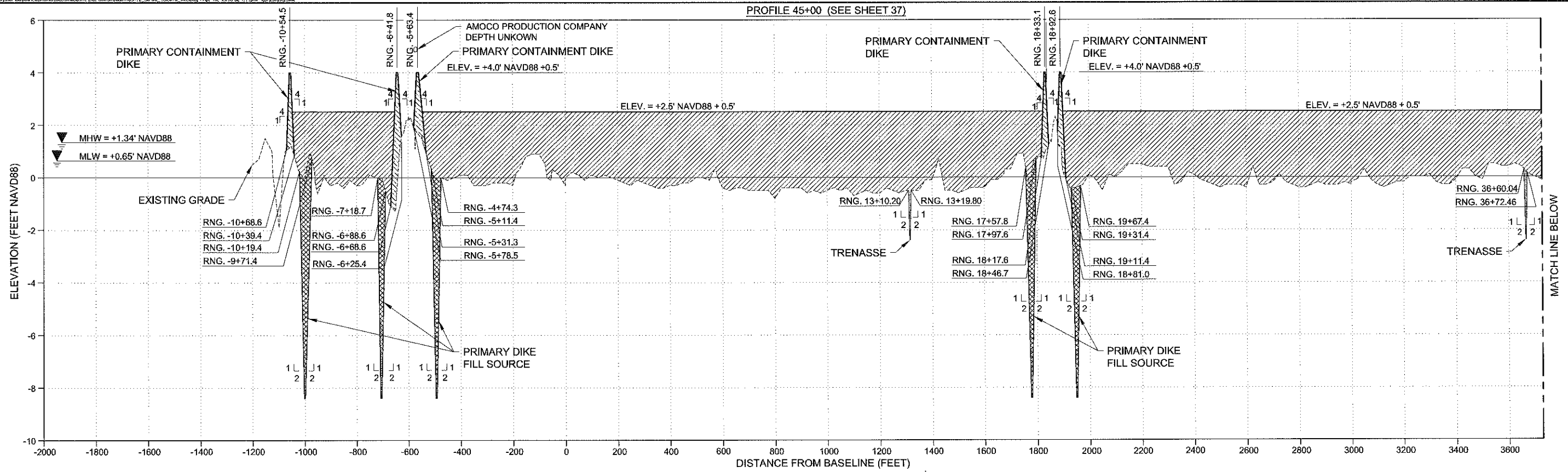

LEGEND:

- CONTAINMENT DIKE
- MARSH FILL
- FILL SOURCE
- TRENASSE

NOTES:

1. ELEVATIONS SHOWN HEREON ARE IN FEET BASED ON NAVD 1988.
2. SURVEY ELEVATIONS SHOWN ON THE PLANS ARE FROM SURVEY DATA COLLECTED IN AUGUST AND SEPTEMBER 2012 BY LONNIE G. HARPER AND ASSOCIATES.
3. LAYOUT ALL FILL AREAS BY CROSS SECTIONS.
4. POSITIVE RANGES ARE WEST OF BASELINE. NEGATIVE RANGES ARE EAST OF BASELINE.
5. LOCATIONS OF PIPELINES ARE APPROXIMATE. CONTRACTOR SHALL VERIFY EXACT LOCATION PRIOR TO EXCAVATION.
6. NO EXCAVATION IS ALLOWED WITHIN 50 FEET OF A PIPELINE.

REV.	DATE	DESCRIPTION	BY

CB&I COASTAL PLANNING & ENGINEERING, INC.
 2481 N.W. BOCA RATON BOULEVARD
 BOCA RATON, FLORIDA 33431
 PH. (561) 391-8102
 FAX (561) 391-9116
 C.O.A. FL #4028
 C.O.A. LA #2531
 www.CBI.COM

COASTAL PROTECTION AND RESTORATION AUTHORITY
 450 LAUREL STREET
 BATON ROUGE, LOUISIANA 70801
 DRAWN BY: GK
 DESIGNED BY: CP

OYSTER BAYOU MARSH RESTORATION PROJECT
 STATE PROJECT NUMBER: CS-59
 FEDERAL PROJECT NUMBER: CS-59
 APPROVED BY: WT

MARSH CREATION CONSTRUCTION PROFILES
 DATE: APRIL 13, 2016
 SHEET 45 OF 69

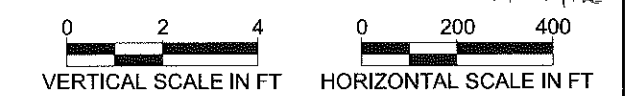
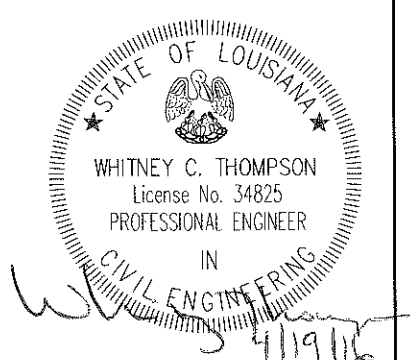

PROFILE 50+00 (SEE SHEET 37)

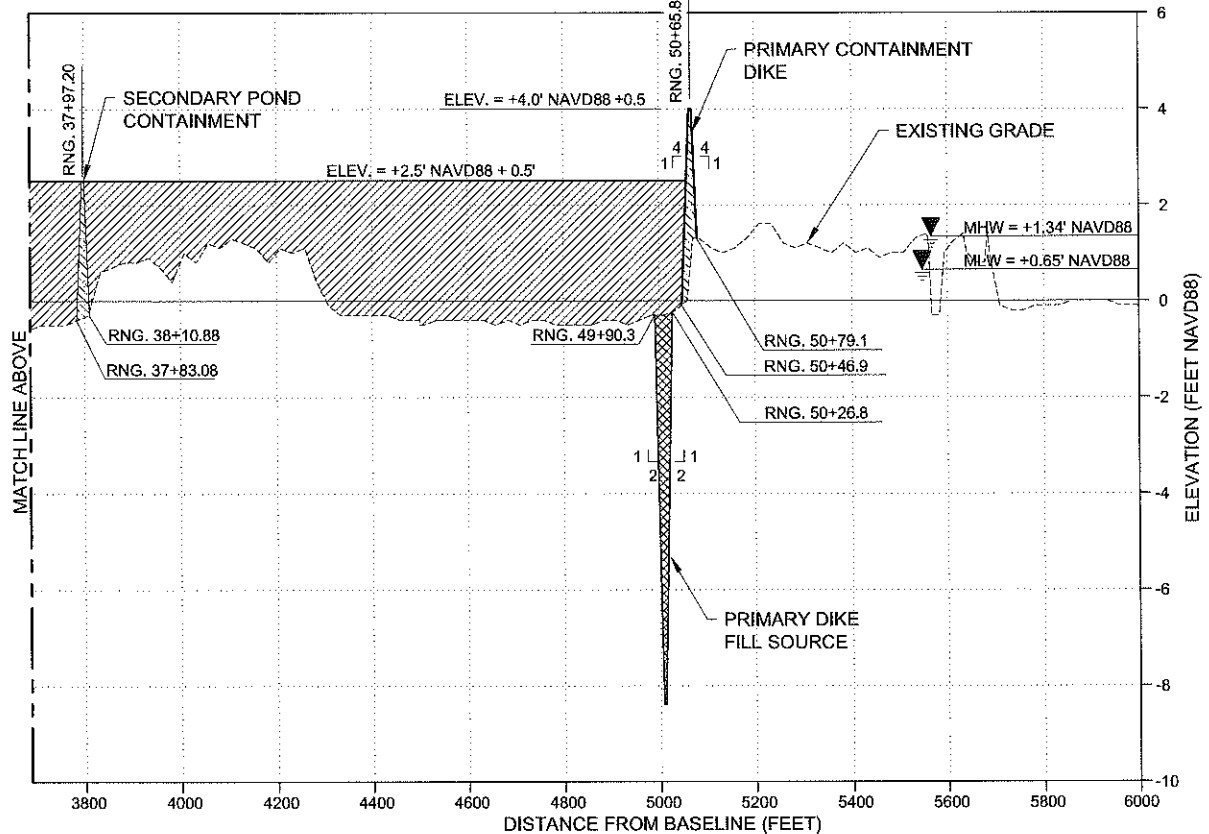
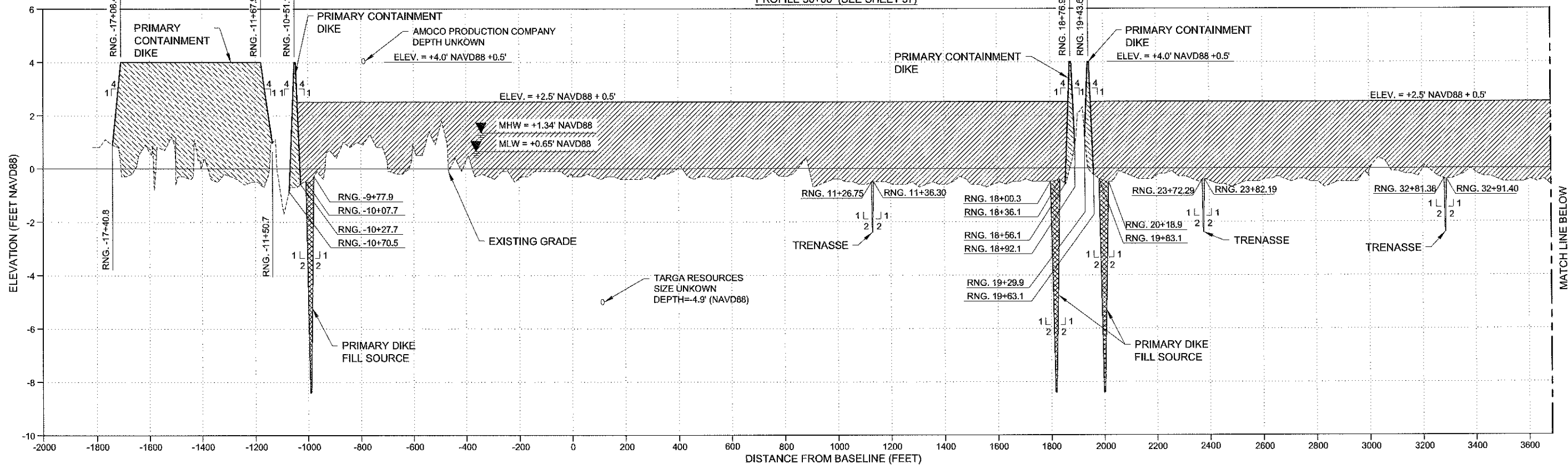

LEGEND:

- CONTAINMENT DIKE
- MARSH FILL
- FILL SOURCE
- TRENASSE

NOTES:

1. ELEVATIONS SHOWN HEREON ARE IN FEET BASED ON NAVD 1988.
2. SURVEY ELEVATIONS SHOWN ON THE PLANS ARE FROM SURVEY DATA COLLECTED IN AUGUST AND SEPTEMBER 2012 BY LONNIE G. HARPER AND ASSOCIATES.
3. LAYOUT ALL FILL AREAS BY CROSS SECTIONS.
4. POSITIVE RANGES ARE WEST OF BASELINE. NEGATIVE RANGES ARE EAST OF BASELINE.
5. LOCATIONS OF PIPELINES ARE APPROXIMATE. CONTRACTOR SHALL VERIFY EXACT LOCATION PRIOR TO EXCAVATION.
6. NO EXCAVATION IS ALLOWED WITHIN 50 FEET OF A PIPELINE.

REV.	DATE	DESCRIPTION	BY

CB&I COASTAL PLANNING & ENGINEERING, INC.

2481 N.W. BOCA RATON BOULEVARD
BOCA RATON, FLORIDA 33431

PH. (561) 391-8102
FAX (561) 391-9116

C.O.A. FL. #4028
C.O.A. LA. #2531
www.CBI.COM

COASTAL PROTECTION AND RESTORATION AUTHORITY

450 LAUREL STREET
BATON ROUGE, LOUISIANA 70801

DRAWN BY: GK

DESIGNED BY: CP

OYSTER BAYOU MARSH RESTORATION PROJECT

STATE PROJECT NUMBER: CS-59

FEDERAL PROJECT NUMBER: CS-59

APPROVED BY: WT

MARSH CREATION CONSTRUCTION PROFILES

DATE: APRIL 13, 2016

SHEET 46 OF 69

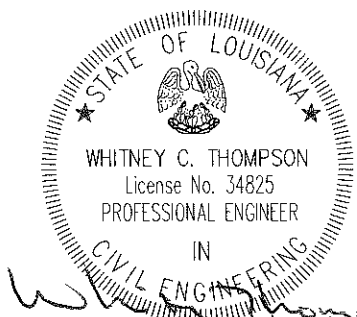

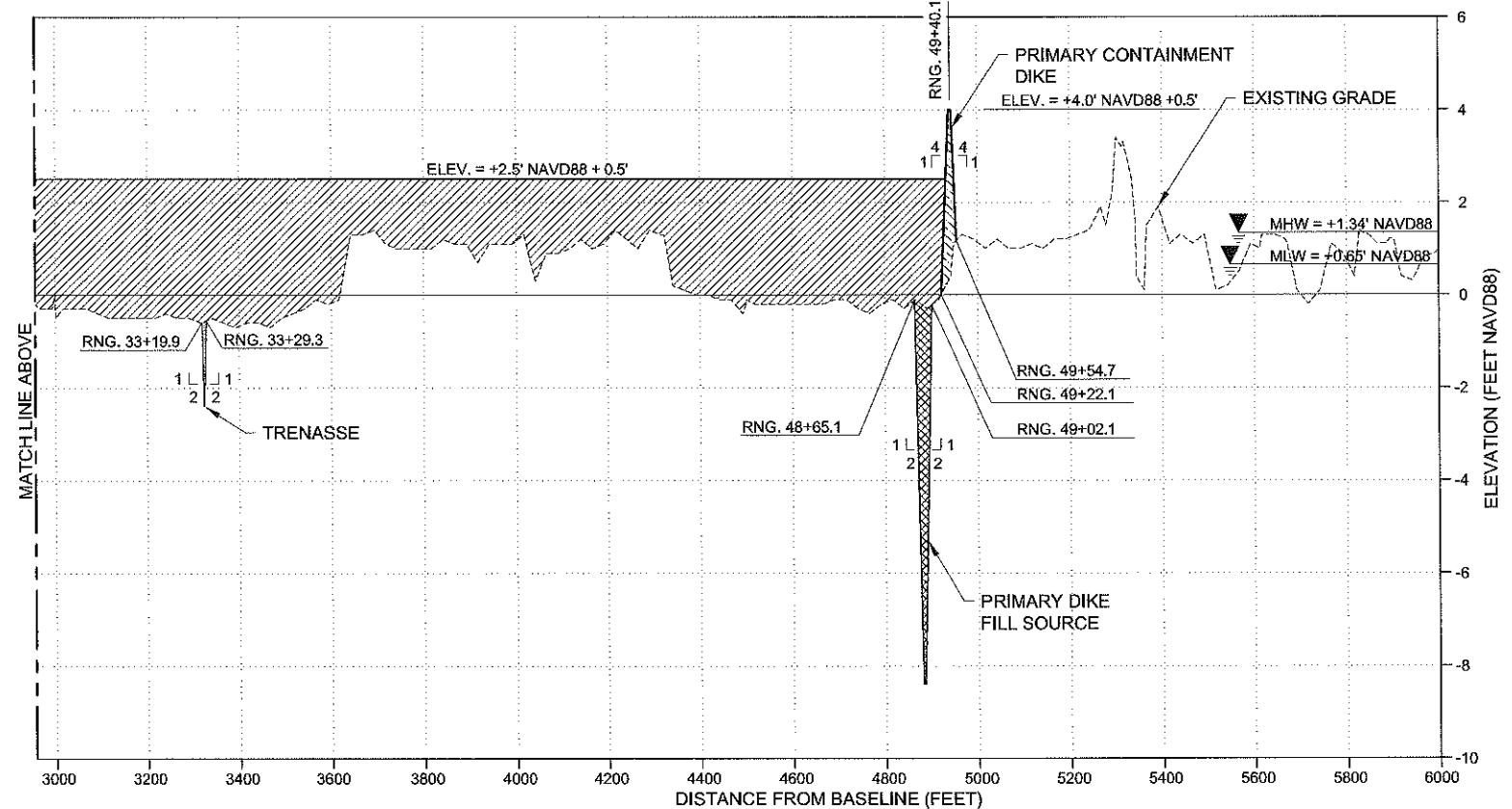
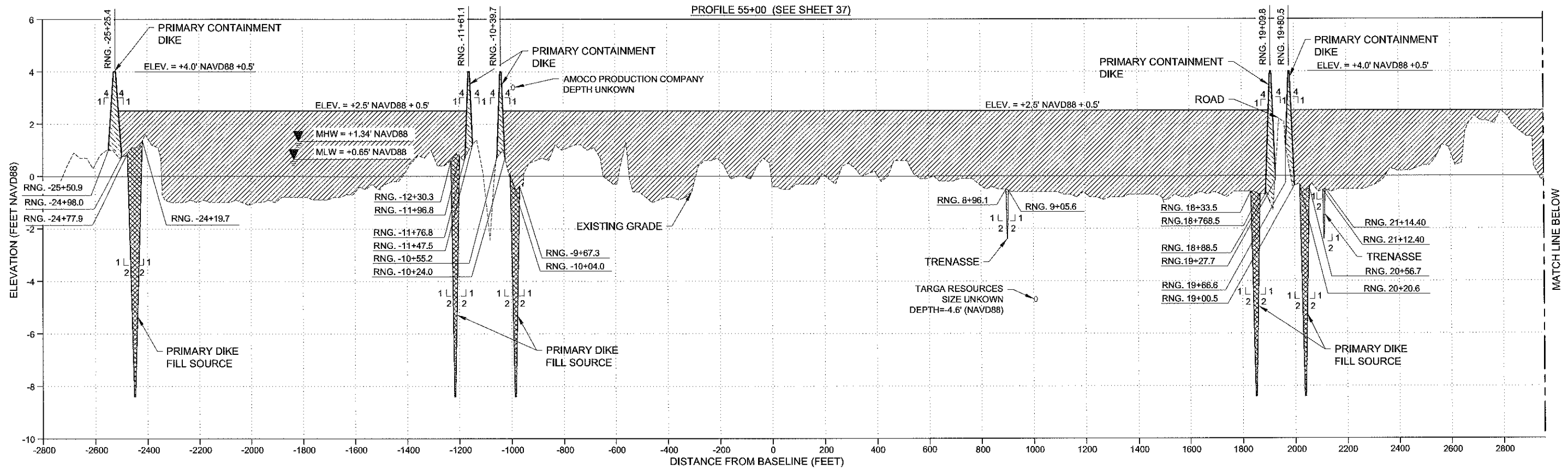

LEGEND:

- CONTAINMENT DIKE
- MARSH FILL
- FILL SOURCE
- TRENASSE

NOTES:

1. ELEVATIONS SHOWN HEREON ARE IN FEET BASED ON NAVD 1988.
2. SURVEY ELEVATIONS SHOWN ON THE PLANS ARE FROM SURVEY DATA COLLECTED IN AUGUST AND SEPTEMBER 2012 BY LONNIE G. HARPER AND ASSOCIATES.
3. LAYOUT ALL FILL AREAS BY CROSS SECTIONS.
4. POSITIVE RANGES ARE WEST OF BASELINE. NEGATIVE RANGES ARE EAST OF BASELINE.
5. LOCATIONS OF PIPELINES ARE APPROXIMATE. CONTRACTOR SHALL VERIFY EXACT LOCATION PRIOR TO EXCAVATION.
6. NO EXCAVATION IS ALLOWED WITHIN 50 FEET OF A PIPELINE.

REV.	DATE	DESCRIPTION	BY

CB&I COASTAL PLANNING & ENGINEERING, INC.
 2481 N.W. BOCA RATON BOULEVARD
 BOCA RATON, FLORIDA 33431
 PH. (561) 391-8102
 FAX (561) 391-9116
 C.O.A. FL. #4028
 C.O.A. LA. #2531
 www.CBI.COM

COASTAL PROTECTION AND RESTORATION AUTHORITY
 450 LAUREL STREET
 BATON ROUGE, LOUISIANA 70801
 DRAWN BY: GK
 DESIGNED BY: CP

OYSTER BAYOU MARSH RESTORATION PROJECT
 STATE PROJECT NUMBER: CS-59
 FEDERAL PROJECT NUMBER: CS-59
 APPROVED BY: WT

MARSH CREATION CONSTRUCTION PROFILES
 DATE: APRIL 13, 2016
 SHEET 47 OF 69

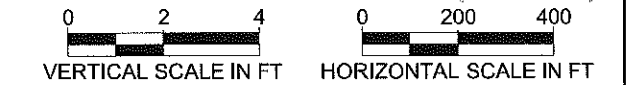
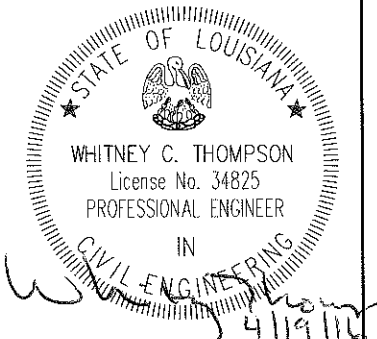

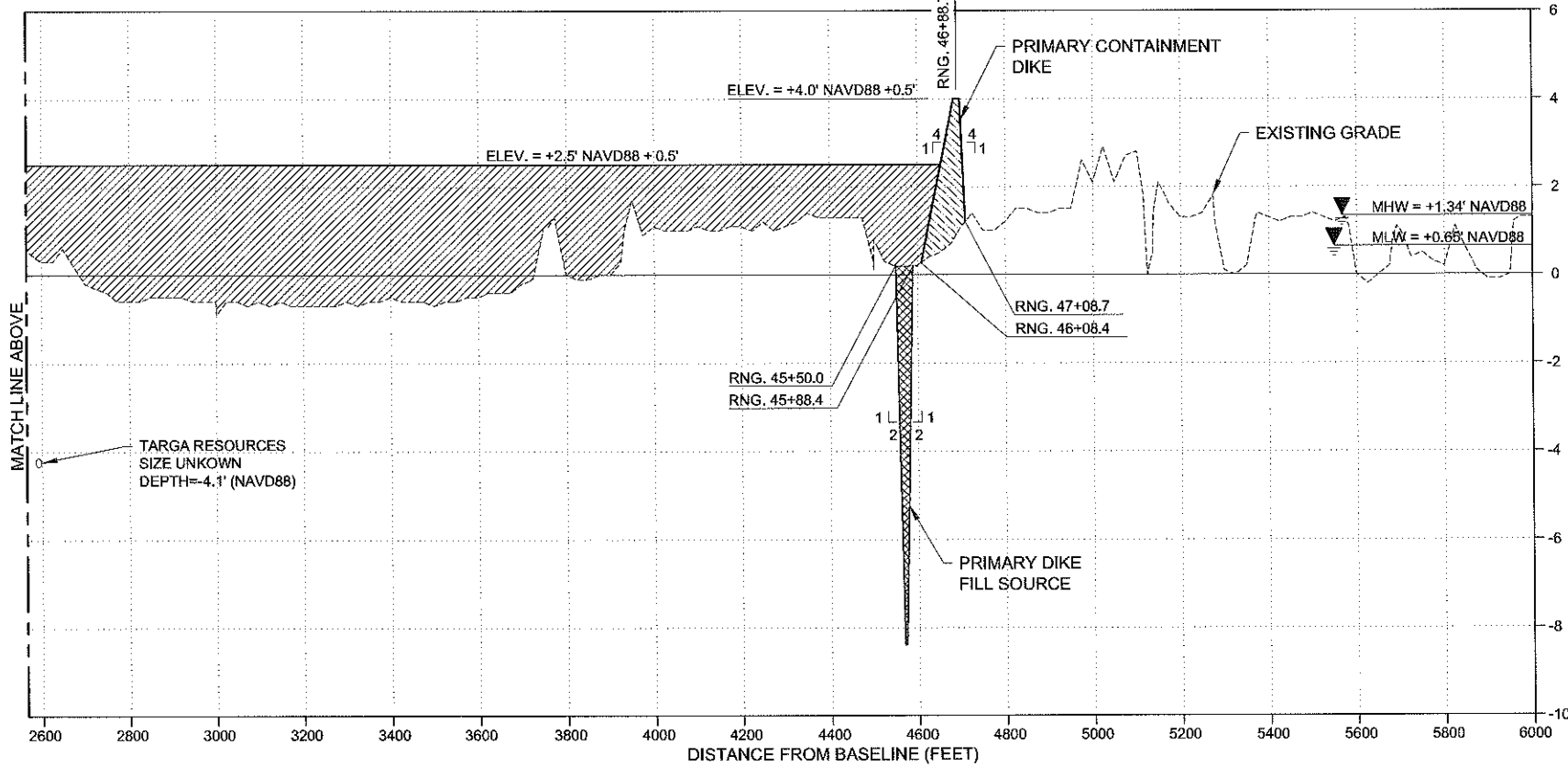
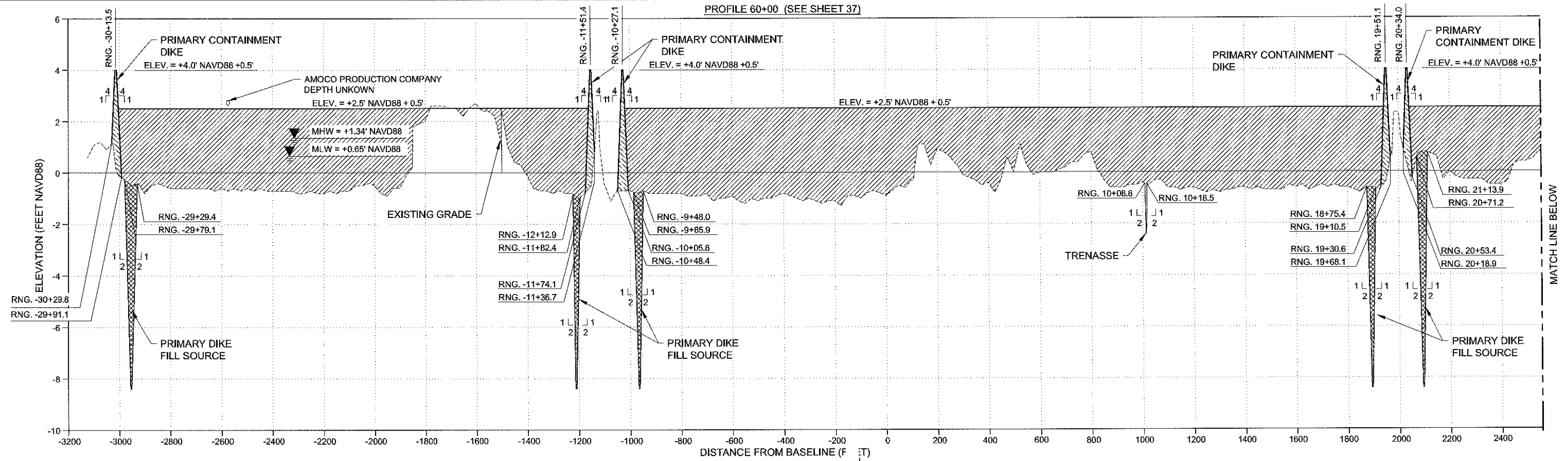

LEGEND:

- CONTAINMENT DIKE
- MARSH FILL
- FILL SOURCE
- TRENASSE

NOTES:

1. ELEVATIONS SHOWN HEREON ARE IN FEET BASED ON NAVD 1988.
2. SURVEY ELEVATIONS SHOWN ON THE PLANS ARE FROM SURVEY DATA COLLECTED IN AUGUST AND SEPTEMBER 2012 BY LONNIE G. HARPER AND ASSOCIATES.
3. LAYOUT ALL FILL AREAS BY CROSS SECTIONS.
4. POSITIVE RANGES ARE WEST OF BASELINE. NEGATIVE RANGES ARE EAST OF BASELINE.
5. LOCATIONS OF PIPELINES ARE APPROXIMATE. CONTRACTOR SHALL VERIFY EXACT LOCATION PRIOR TO EXCAVATION.
6. NO EXCAVATION IS ALLOWED WITHIN 50 FEET OF A PIPELINE.

REV.	DATE	DESCRIPTION	BY

CB&I COASTAL PLANNING & ENGINEERING, INC.

2481 N.W. BOCA RATON BOULEVARD
BOCA RATON, FLORIDA 33441

PH. (561) 391-8102
FAX (561) 391-9116

C.O.A. FL. #4028
C.O.A. LA. #2531
www.CBI.COM

COASTAL PROTECTION AND RESTORATION AUTHORITY

450 LAUREL STREET
BATON ROUGE, LOUISIANA 70801

DRAWN BY: GK

DESIGNED BY: CP

OYSTER BAYOU MARSH RESTORATION PROJECT

STATE PROJECT NUMBER: CS-59

FEDERAL PROJECT NUMBER: CS-59

APPROVED BY: WT

MARSH CREATION CONSTRUCTION PROFILES

DATE: APRIL 13, 2016

SHEET 48 OF 69

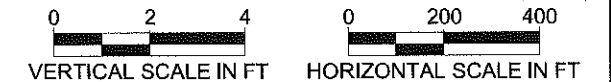
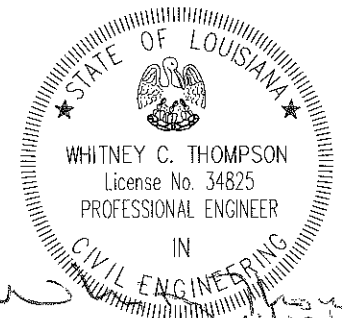

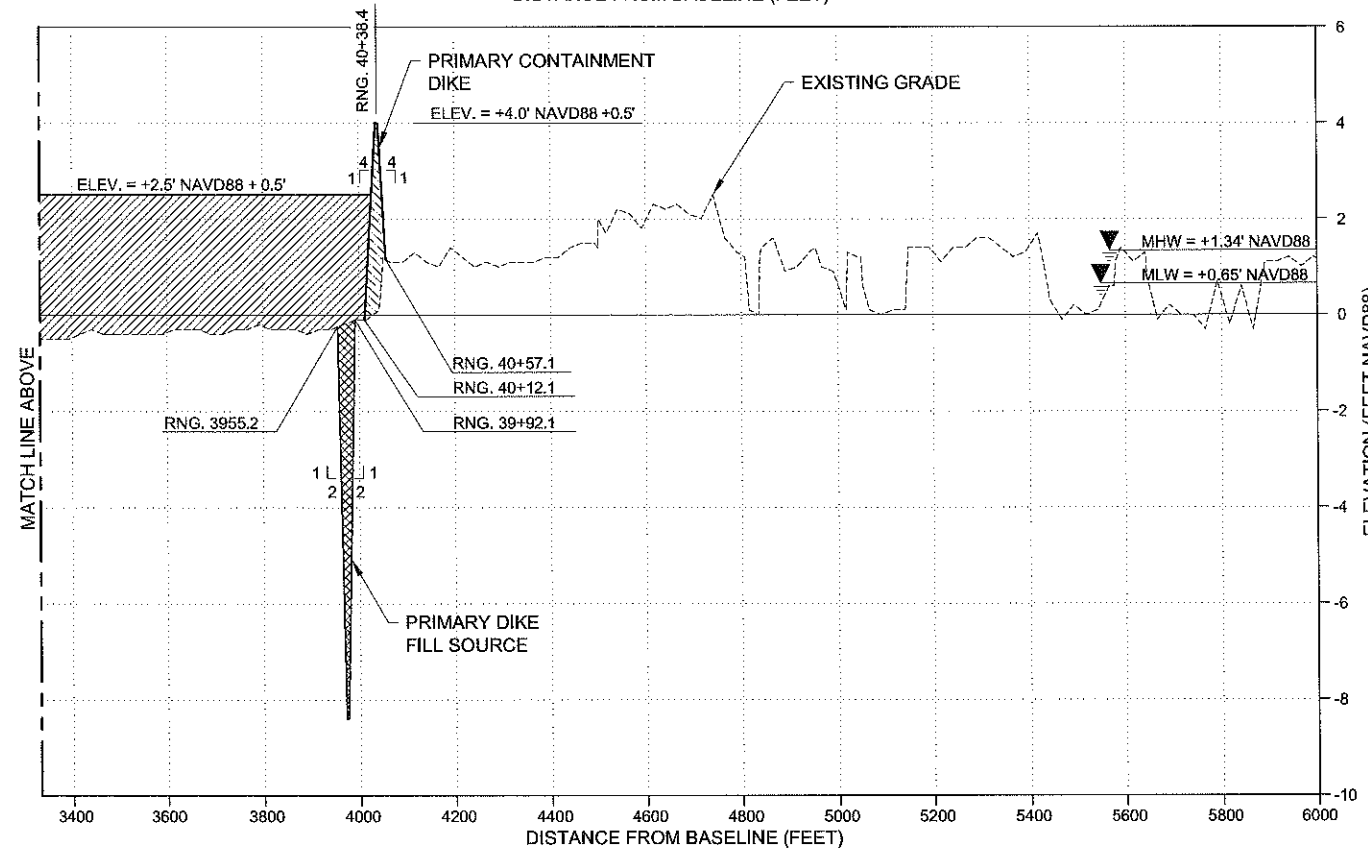
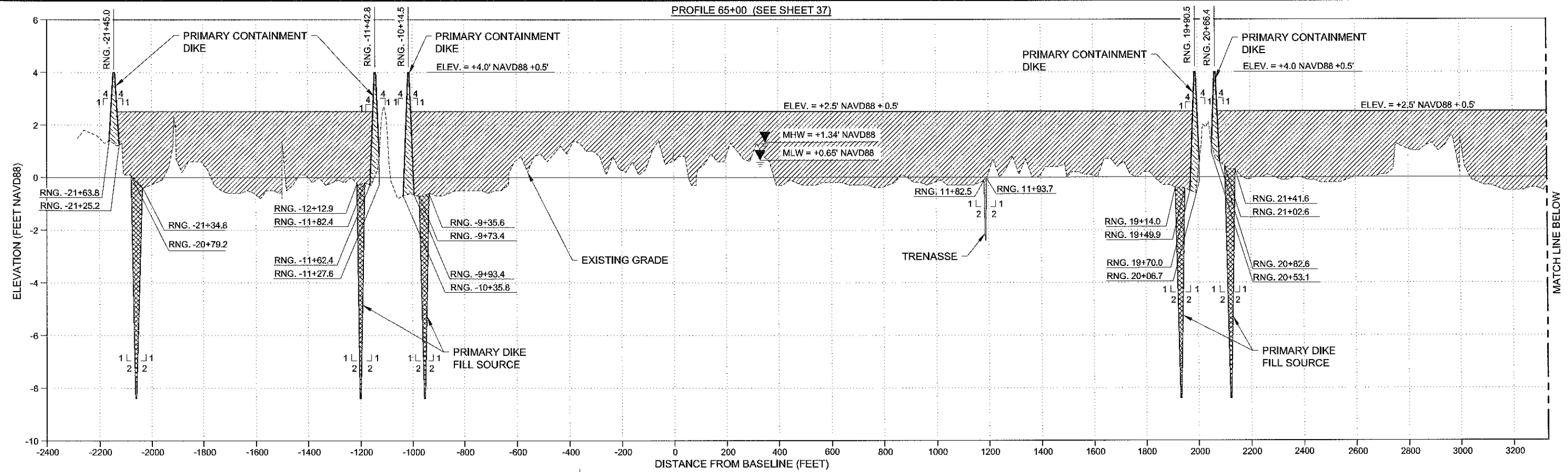

LEGEND:

- CONTAINMENT DIKE
- MARSH FILL
- FILL SOURCE
- TRENASSE

NOTES:

1. ELEVATIONS SHOWN HEREON ARE IN FEET BASED ON NAVD 1988.
2. SURVEY ELEVATIONS SHOWN ON THE PLANS ARE FROM SURVEY DATA COLLECTED IN AUGUST AND SEPTEMBER 2012 BY LONNIE G. HARPER AND ASSOCIATES.
3. LAYOUT ALL FILL AREAS BY CROSS SECTIONS.
4. POSITIVE RANGES ARE WEST OF BASELINE. NEGATIVE RANGES ARE EAST OF BASELINE.
5. LOCATIONS OF PIPELINES ARE APPROXIMATE. CONTRACTOR SHALL VERIFY EXACT LOCATION PRIOR TO EXCAVATION.
6. NO EXCAVATION IS ALLOWED WITHIN 50 FEET OF A PIPELINE.

REV.	DATE	DESCRIPTION	BY

CB&I COASTAL PLANNING & ENGINEERING, INC.
 2481 N.W. BOCA RATON BOULEVARD
 BOCA RATON, FLORIDA 33431
 PH. (561) 391-8102
 FAX (561) 391-9116
 C.O.A. FL. #4028
 C.O.A. LA. #2531
 www.CBI.COM

COASTAL PROTECTION AND RESTORATION AUTHORITY
 450 LAUREL STREET
 BATON ROUGE, LOUISIANA 70801
 DRAWN BY: GK
 DESIGNED BY: CP

OYSTER BAYOU MARSH RESTORATION PROJECT
 STATE PROJECT NUMBER: CS-59
 FEDERAL PROJECT NUMBER: CS-59
 APPROVED BY: WT

MARSH CREATION CONSTRUCTION PROFILES
 DATE: APRIL 13, 2016
 SHEET 49 OF 69

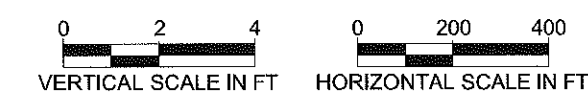
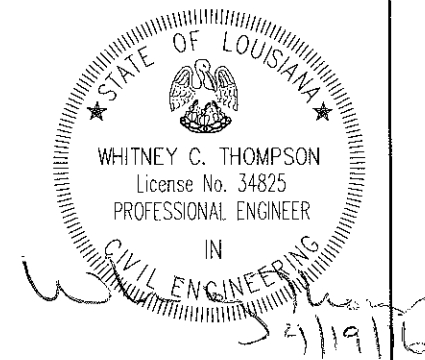

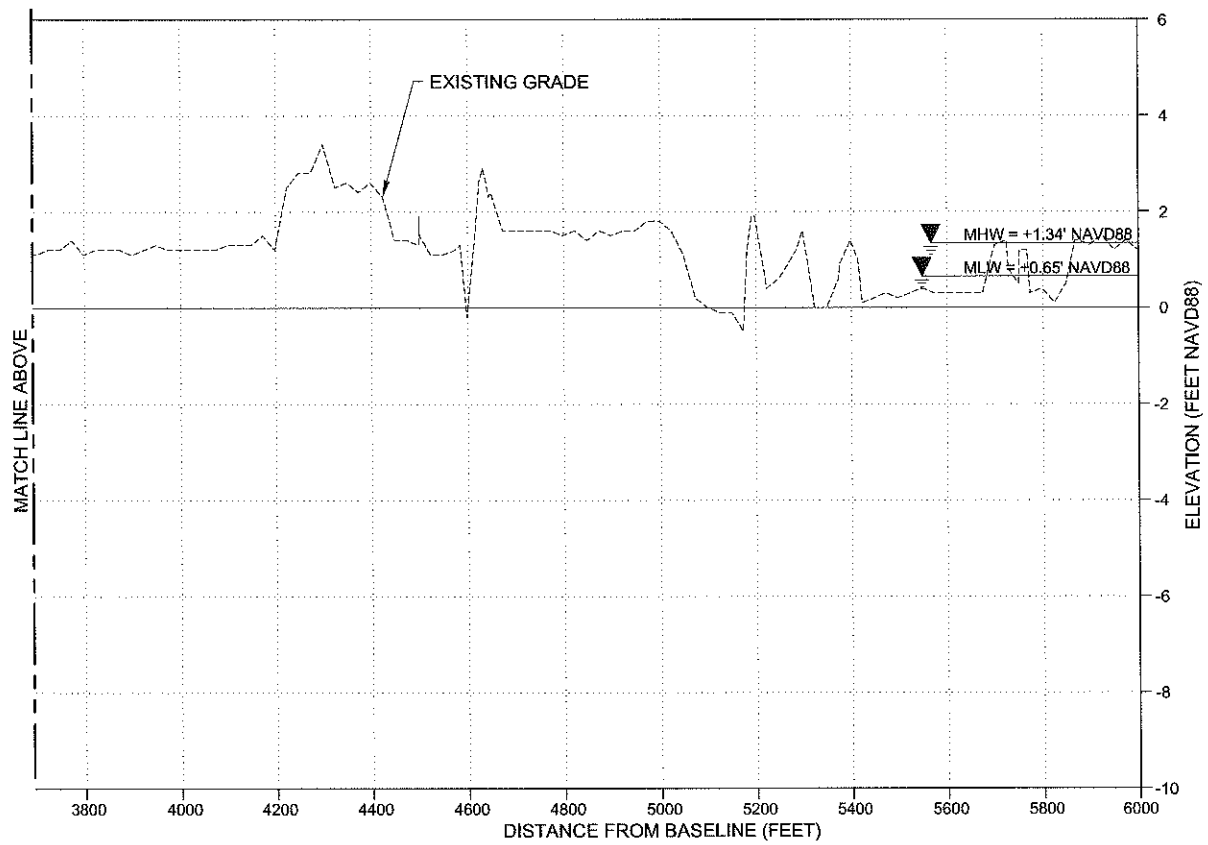
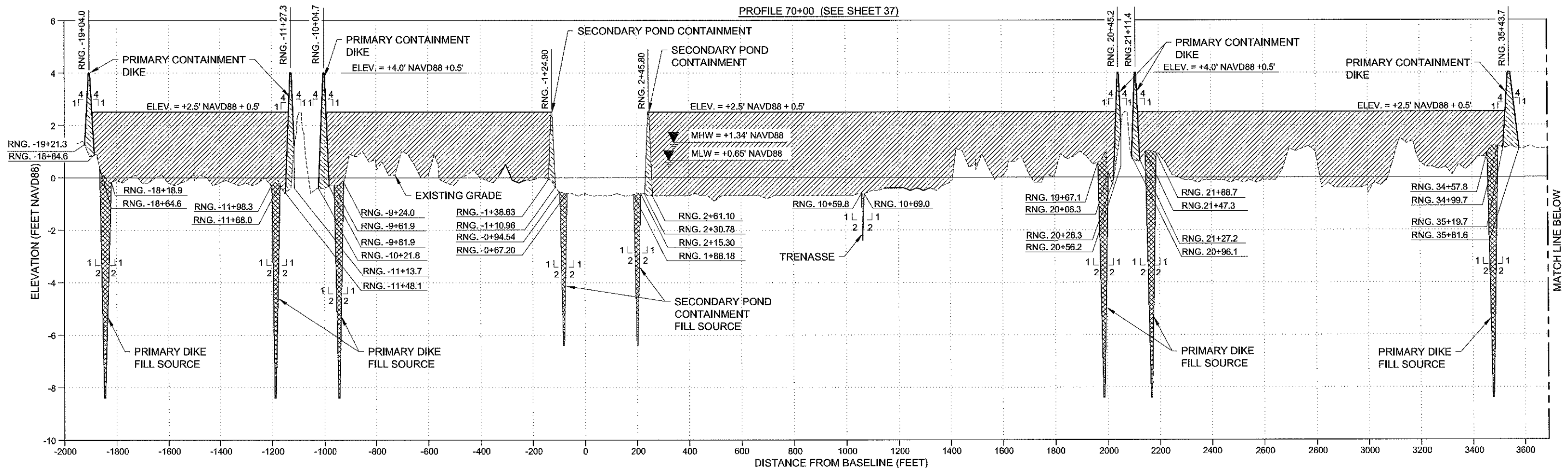

LEGEND:

- CONTAINMENT DIKE
- MARSH FILL
- FILL SOURCE
- TRENASSE

NOTES:

1. ELEVATIONS SHOWN HEREON ARE IN FEET BASED ON NAVD 1988.
2. SURVEY ELEVATIONS SHOWN ON THE PLANS ARE FROM SURVEY DATA COLLECTED IN AUGUST AND SEPTEMBER 2012 BY LONNIE G. HARPER AND ASSOCIATES.
3. LAYOUT ALL FILL AREAS BY CROSS SECTIONS.
4. POSITIVE RANGES ARE WEST OF BASELINE. NEGATIVE RANGES ARE EAST OF BASELINE.
5. LOCATIONS OF PIPELINES ARE APPROXIMATE. CONTRACTOR SHALL VERIFY EXACT LOCATION PRIOR TO EXCAVATION.
6. NO EXCAVATION IS ALLOWED WITHIN 50 FEET OF A PIPELINE.

REV.	DATE	DESCRIPTION	BY

CB&I COASTAL PLANNING & ENGINEERING, INC.
 2481 N.W. BOCA RATON BOULEVARD
 BOCA RATON, FLORIDA 33431
 PH. (561) 391-8102
 FAX (561) 391-9116
 C.O.A. FL. #4028
 C.O.A. LA. #2531
 www.CBI.COM

COASTAL PROTECTION AND RESTORATION AUTHORITY
 450 LAUREL STREET
 BATON ROUGE, LOUISIANA 70801

OYSTER BAYOU MARSH RESTORATION PROJECT
 STATE PROJECT NUMBER: CS-59
 FEDERAL PROJECT NUMBER: CS-59
 APPROVED BY: WT

MARSH CREATION CONSTRUCTION PROFILES
 DATE: APRIL 13, 2016
 SHEET 50 OF 69

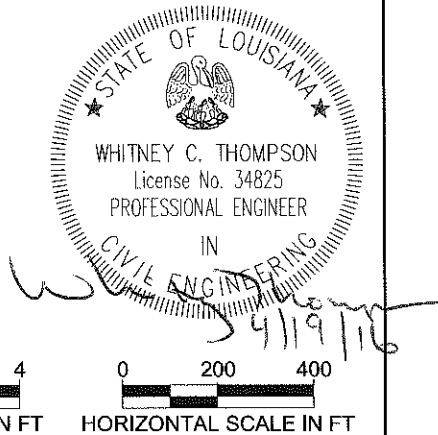

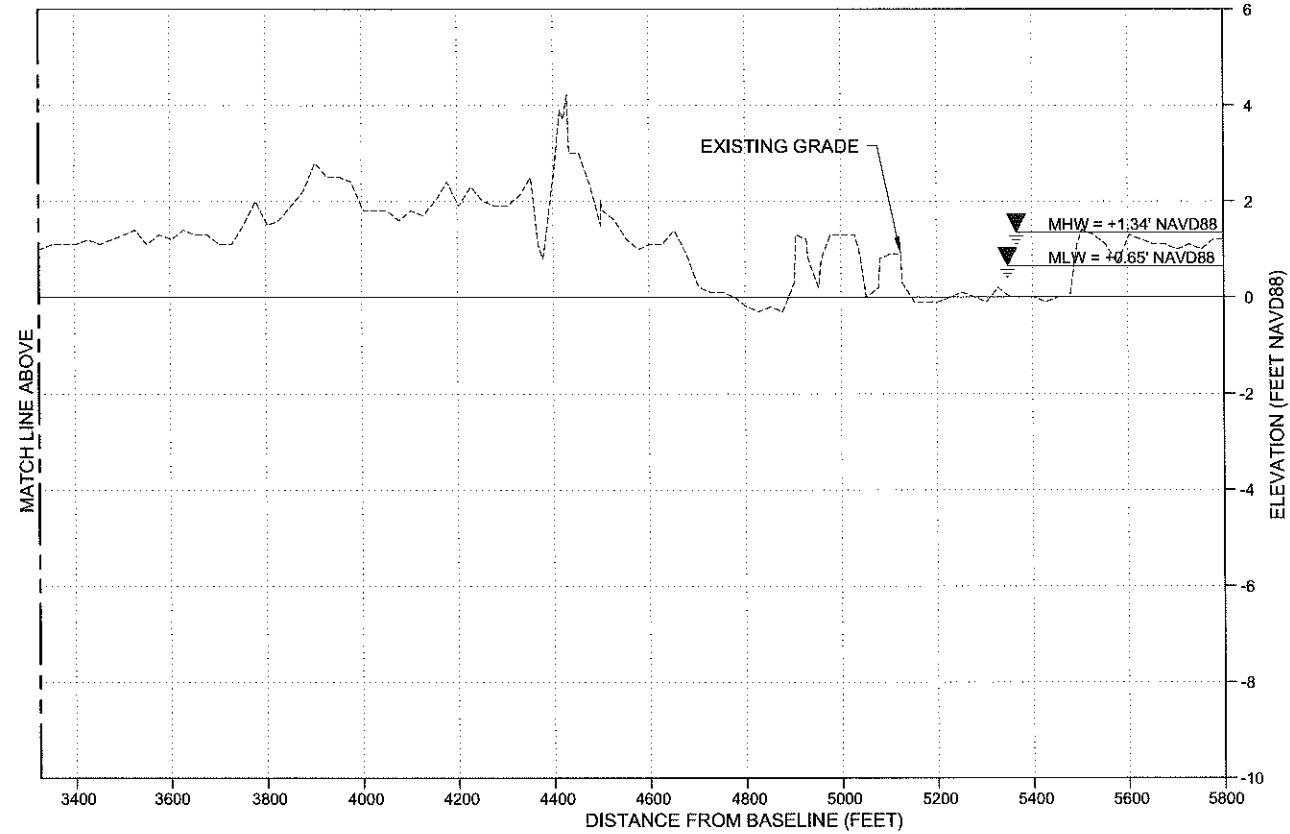
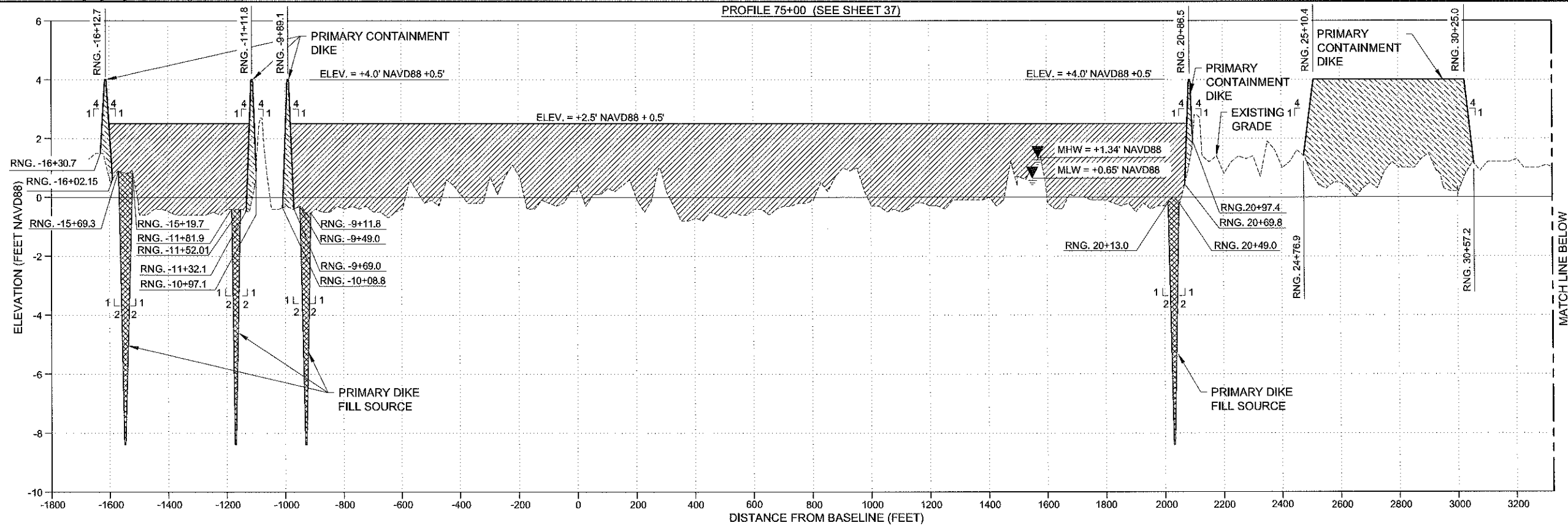

LEGEND:
 CONTAINMENT DIKE
 MARSH FILL
 FILL SOURCE

- NOTES:**
- ELEVATIONS SHOWN HEREON ARE IN FEET BASED ON NAVD 1988.
 - SURVEY ELEVATIONS SHOWN ON THE PLANS ARE FROM SURVEY DATA COLLECTED IN AUGUST AND SEPTEMBER 2012 BY LONNIE G. HARPER AND ASSOCIATES.
 - LAYOUT ALL FILL AREAS BY CROSS SECTIONS.
 - POSITIVE RANGES ARE WEST OF BASELINE. NEGATIVE RANGES ARE EAST OF BASELINE.
 - LOCATIONS OF PIPELINES ARE APPROXIMATE. CONTRACTOR SHALL VERIFY EXACT LOCATION PRIOR TO EXCAVATION.
 - NO EXCAVATION IS ALLOWED WITHIN 50 FEET OF A PIPELINE.

REV.	DATE	DESCRIPTION	BY

CB&I COASTAL PLANNING & ENGINEERING, INC.
 2481 N.W. BOCA RATON BOULEVARD
 BOCA RATON, FLORIDA 33431
 PH. (561) 391-9102
 FAX (561) 391-9116
 C.O.A. FL. #4028
 C.O.A. LA. #2531
 www.CBI.COM

COASTAL PROTECTION AND RESTORATION AUTHORITY
 450 LAUREL STREET
 BATON ROUGE, LOUISIANA 70801
 DRAWN BY: GK
 DESIGNED BY: CP

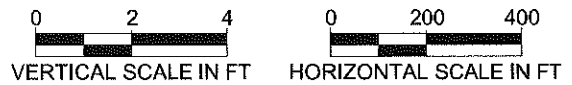
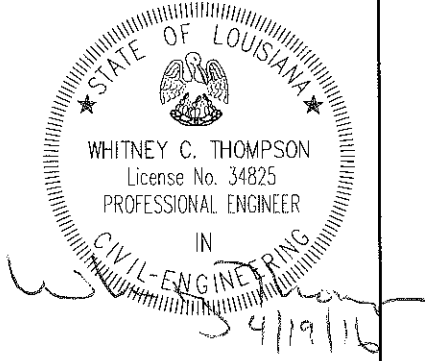

OYSTER BAYOU MARSH RESTORATION PROJECT
 STATE PROJECT NUMBER: CS-59
 FEDERAL PROJECT NUMBER: CS-59
 APPROVED BY: WT

MARSH CREATION CONSTRUCTION PROFILES
 DATE: APRIL 13, 2016
 SHEET 51 OF 69

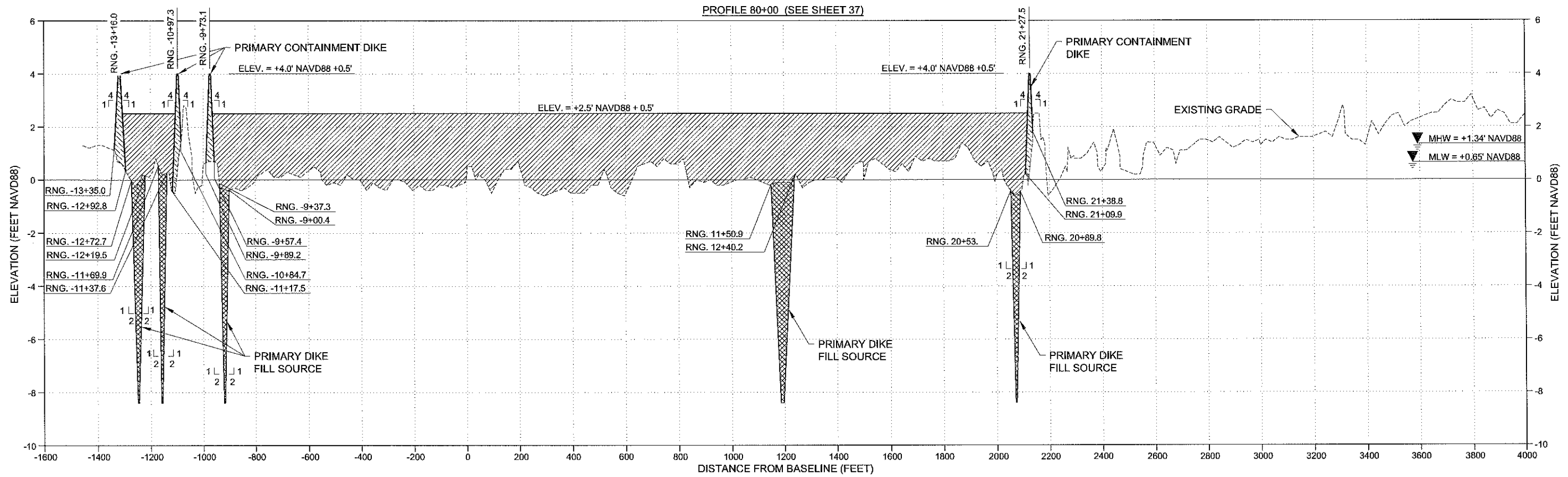



LEGEND:

-  CONTAINMENT DIKE
-  MARSH FILL
-  FILL SOURCE

NOTES:

1. ELEVATIONS SHOWN HEREON ARE IN FEET BASED ON NAVD 1988.
2. SURVEY ELEVATIONS SHOWN ON THE PLANS ARE FROM SURVEY DATA COLLECTED IN AUGUST AND SEPTEMBER 2012 BY LONNIE G. HARPER AND ASSOCIATES.
3. LAYOUT ALL FILL AREAS BY CROSS SECTIONS.
4. POSITIVE RANGES ARE WEST OF BASELINE. NEGATIVE RANGES ARE EAST OF BASELINE.
5. LOCATIONS OF PIPELINES ARE APPROXIMATE. CONTRACTOR SHALL VERIFY EXACT LOCATION PRIOR TO EXCAVATION.
6. NO EXCAVATION IS ALLOWED WITHIN 50 FEET OF A PIPELINE.

REV.	DATE	DESCRIPTION	BY

CB&I COASTAL PLANNING & ENGINEERING, INC.

2481 N.W. BOCA RATON BOULEVARD
BOCA RATON, FLORIDA 33431

PH. (561) 391-9102
FAX (561) 391-9116

C.O.A. FL. #4028
C.O.A. LA. #2531
www.CBI.COM

COASTAL PROTECTION AND RESTORATION AUTHORITY

450 LAUREL STREET
BATON ROUGE, LOUISIANA 70801

DRAWN BY: GK

DESIGNED BY: CP

OYSTER BAYOU MARSH RESTORATION PROJECT

STATE PROJECT NUMBER: CS-59

FEDERAL PROJECT NUMBER: CS-59

APPROVED BY: WT

MARSH CREATION CONSTRUCTION PROFILES

DATE: APRIL 13, 2016

SHEET 52 OF 69

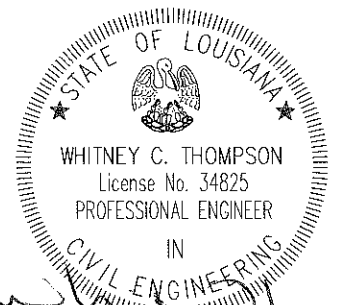

Whitney C. Thompson
4/13/16



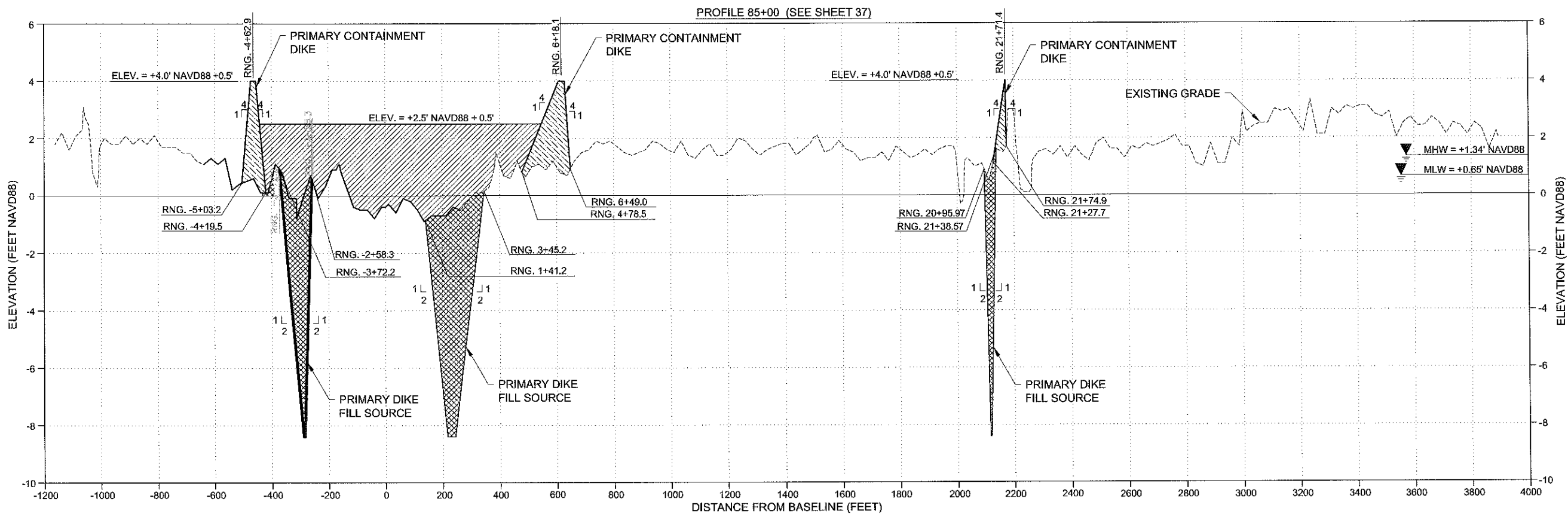

LEGEND:

- CONTAINMENT DIKE
- MARSH FILL
- FILL SOURCE

NOTES:

1. ELEVATIONS SHOWN HEREON ARE IN FEET BASED ON NAVD 1988.
2. SURVEY ELEVATIONS SHOWN ON THE PLANS ARE FROM SURVEY DATA COLLECTED IN AUGUST AND SEPTEMBER 2012 BY LONNIE G. HARPER AND ASSOCIATES.
3. LAYOUT ALL FILL AREAS BY CROSS SECTIONS.
4. POSITIVE RANGES ARE WEST OF BASELINE. NEGATIVE RANGES ARE EAST OF BASELINE.
5. LOCATIONS OF PIPELINES ARE APPROXIMATE. CONTRACTOR SHALL VERIFY EXACT LOCATION PRIOR TO EXCAVATION.
6. NO EXCAVATION IS ALLOWED WITHIN 50 FEET OF A PIPELINE.

REV.	DATE	DESCRIPTION	BY

CB&I COASTAL PLANNING & ENGINEERING, INC.

2481 N.W. BOCA RATON BOULEVARD
BOCA RATON, FLORIDA 33431

PH. (561) 391-8102
FAX (561) 391-8116

C.O.A. FL. #4028
C.O.A. LA. #2531
www.CBI.COM

COASTAL PROTECTION AND RESTORATION AUTHORITY

450 LAUREL STREET
BATON ROUGE, LOUISIANA 70801

DRAWN BY: GK

DESIGNED BY: CP

OYSTER BAYOU MARSH RESTORATION PROJECT

STATE PROJECT NUMBER: CS-59

FEDERAL PROJECT NUMBER: CS-59

APPROVED BY: WT

MARSH CREATION CONSTRUCTION PROFILES

DATE: APRIL 13, 2016

SHEET 53 OF 69

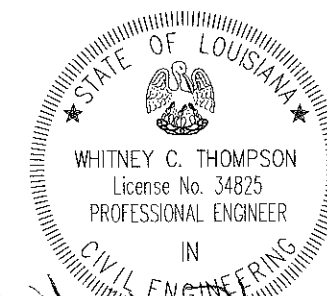

Whitney C. Thompson
4/19/16

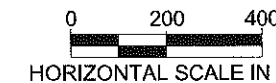
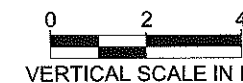

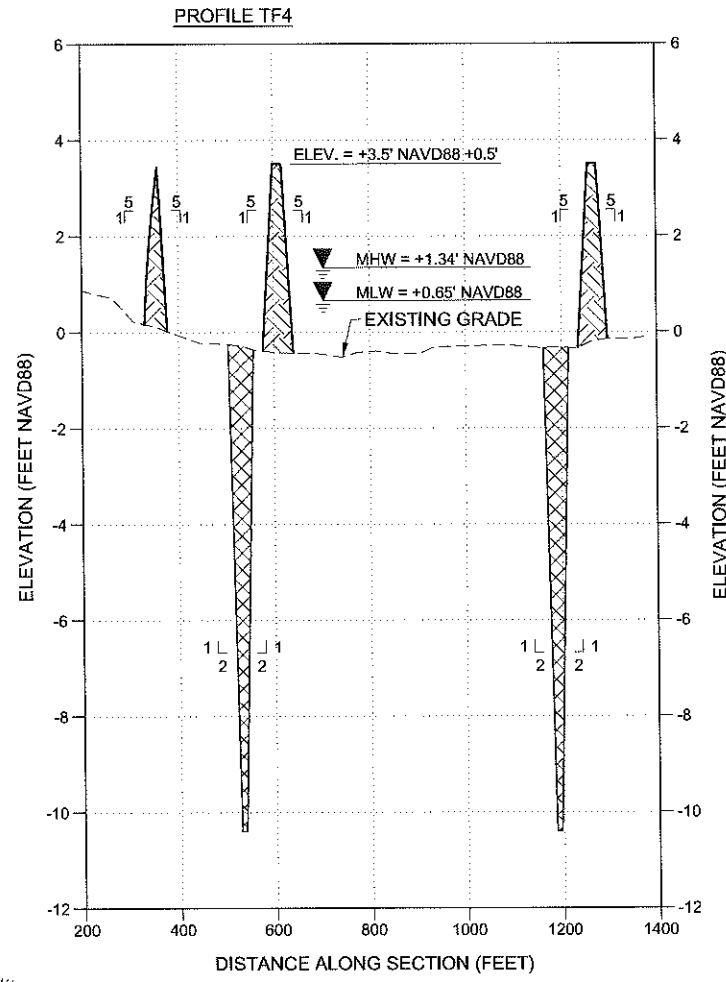
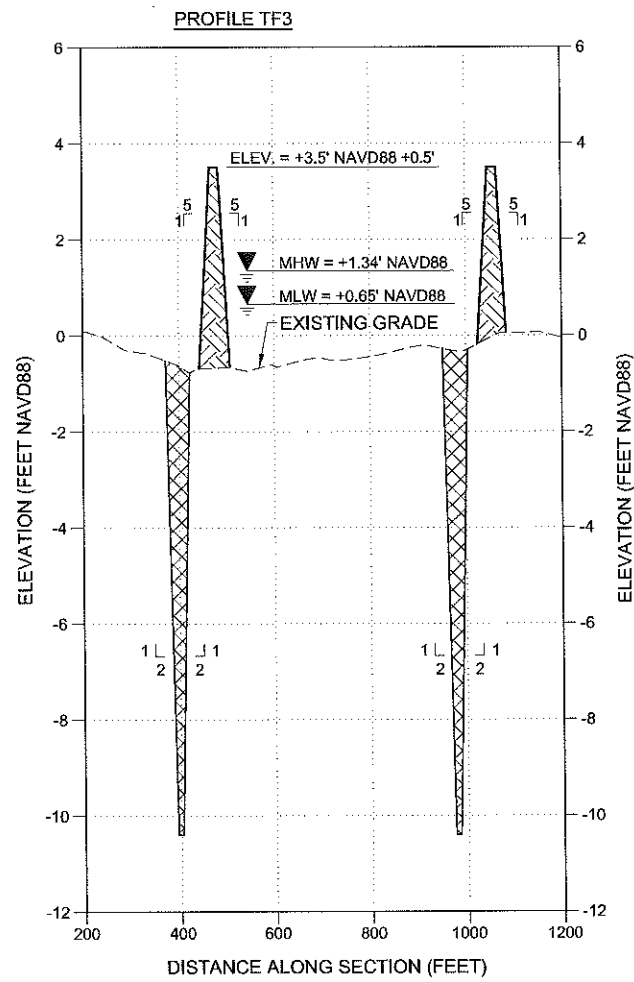
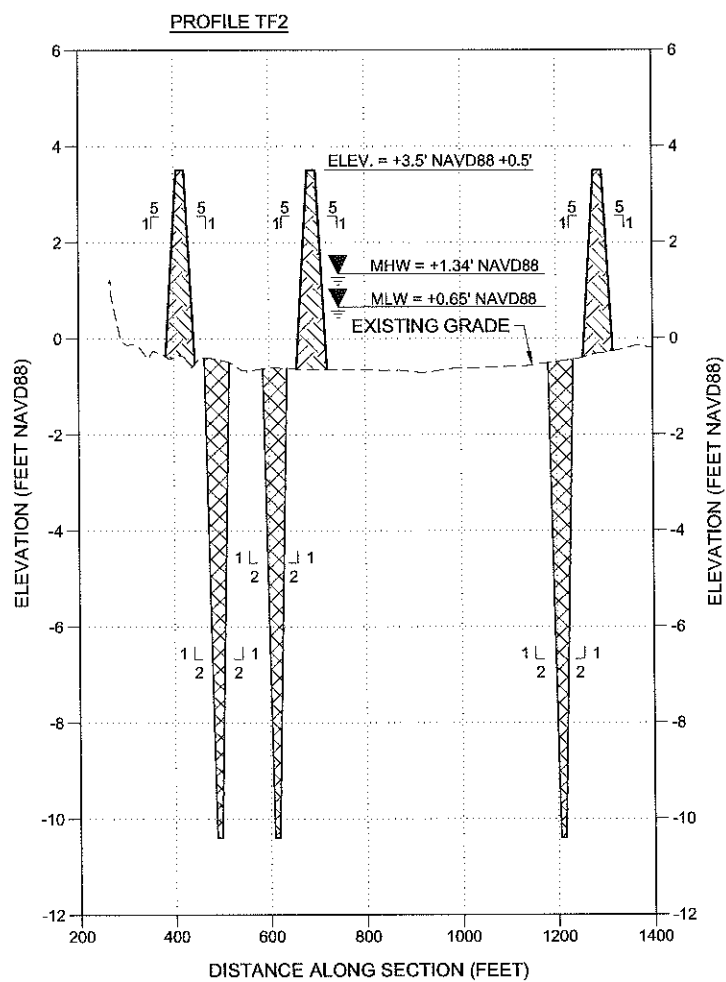
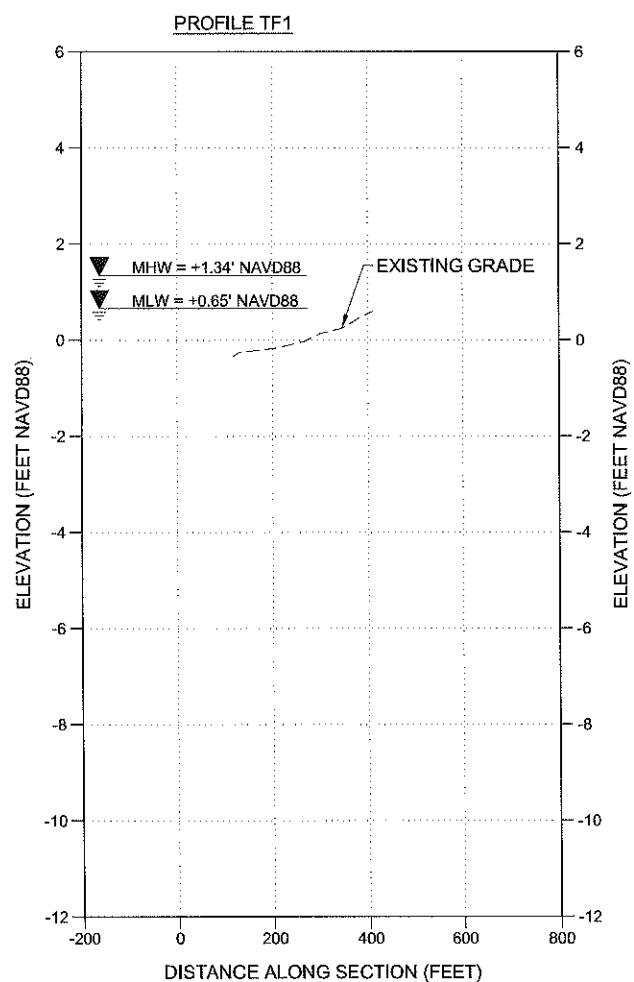

LEGEND:

- EARTHEN TERRACE ELEV. +3.5'
- EARTHEN TERRACE BORROW AREA ELEV. -10.4' (MAX)

NOTES:

1. ELEVATIONS SHOWN HEREON ARE IN FEET BASED ON NAVD 1988.
2. SURVEY ELEVATIONS SHOWN ON THE PLANS ARE FROM SURVEY DATA COLLECTED IN AUGUST AND SEPTEMBER 2012 BY LONNIE G. HARPER AND ASSOCIATES.
3. LAY OUT ALL FILL AREAS BY ALIGNMENT TABLE ON SHEET 4.
4. DISTANCES ARE ALONG SECTION LINE.
5. LOCATIONS OF PIPELINES ARE APPROXIMATE. CONTRACTOR SHALL VERIFY EXACT LOCATION PRIOR TO EXCAVATION.
6. NO EXCAVATION IS ALLOWED WITHIN 50 FEET OF A PIPELINE.
7. SEE SHEETS 16 AND 17 FOR TERRACE FIELD DETAILS.

REV.	DATE	DESCRIPTION	BY

CB&I COASTAL PLANNING & ENGINEERING, INC.
 2481 N.W. BOCA RATON BOULEVARD
 BOCA RATON, FLORIDA 33431

PH. (561) 391-8102
 FAX (561) 391-8116

C.O.A. FL. #4028
 C.O.A. LA. #2531
 www.CBI.COM

COASTAL PROTECTION AND RESTORATION AUTHORITY

450 LAUREL STREET
 BATON ROUGE, LOUISIANA 70801

DRAWN BY: GK

DESIGNED BY: CP

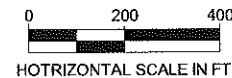
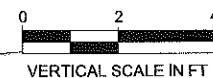
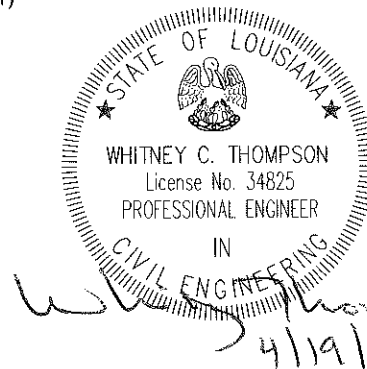

OYSTER BAYOU MARSH RESTORATION PROJECT

STATE PROJECT NUMBER: CS-59

FEDERAL PROJECT NUMBER: CS-59

APPROVED BY: WT

TERRACE FIELD CONSTRUCTION PROFILES

DATE: APRIL 13, 2016

SHEET 54 OF 69

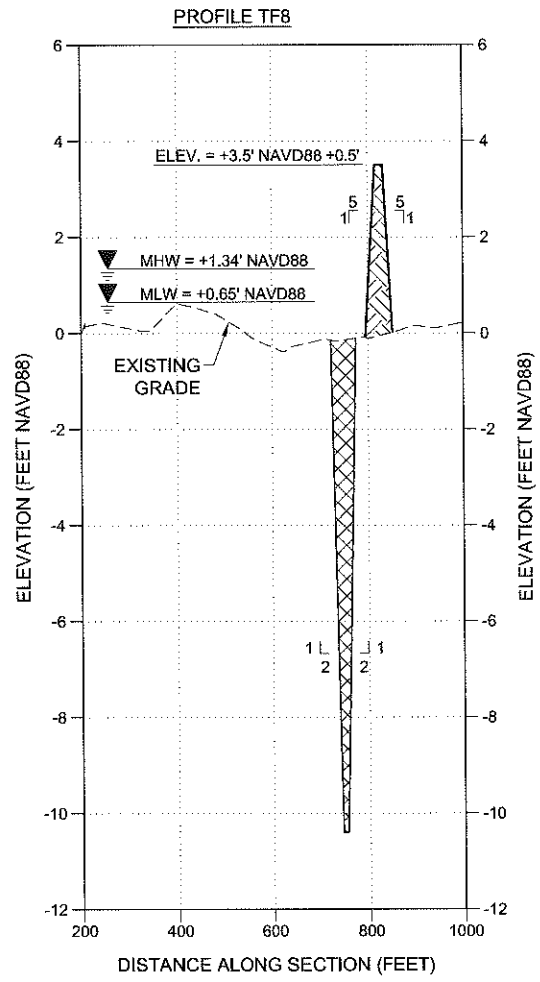
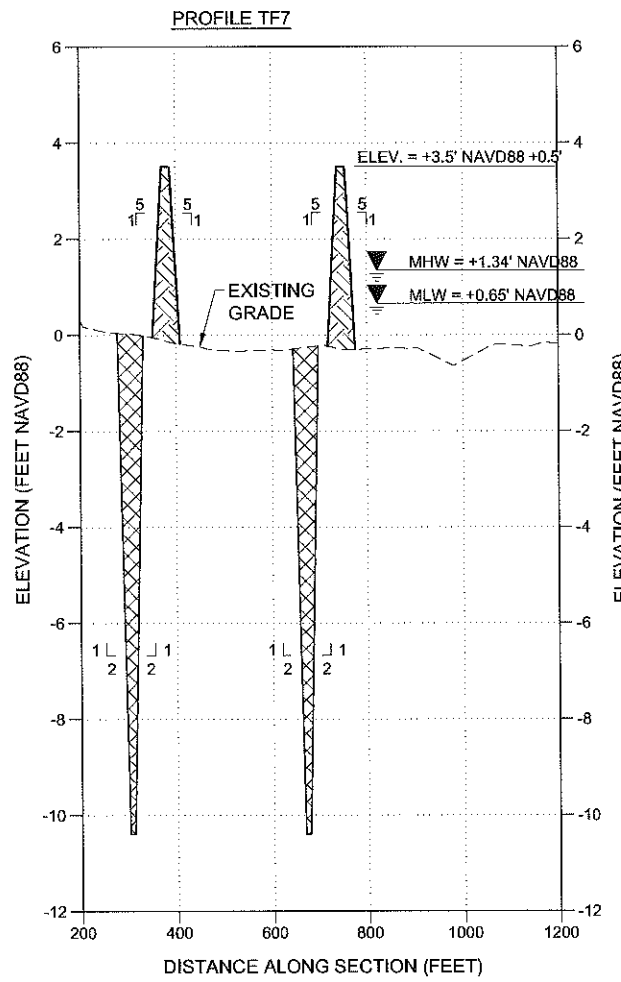
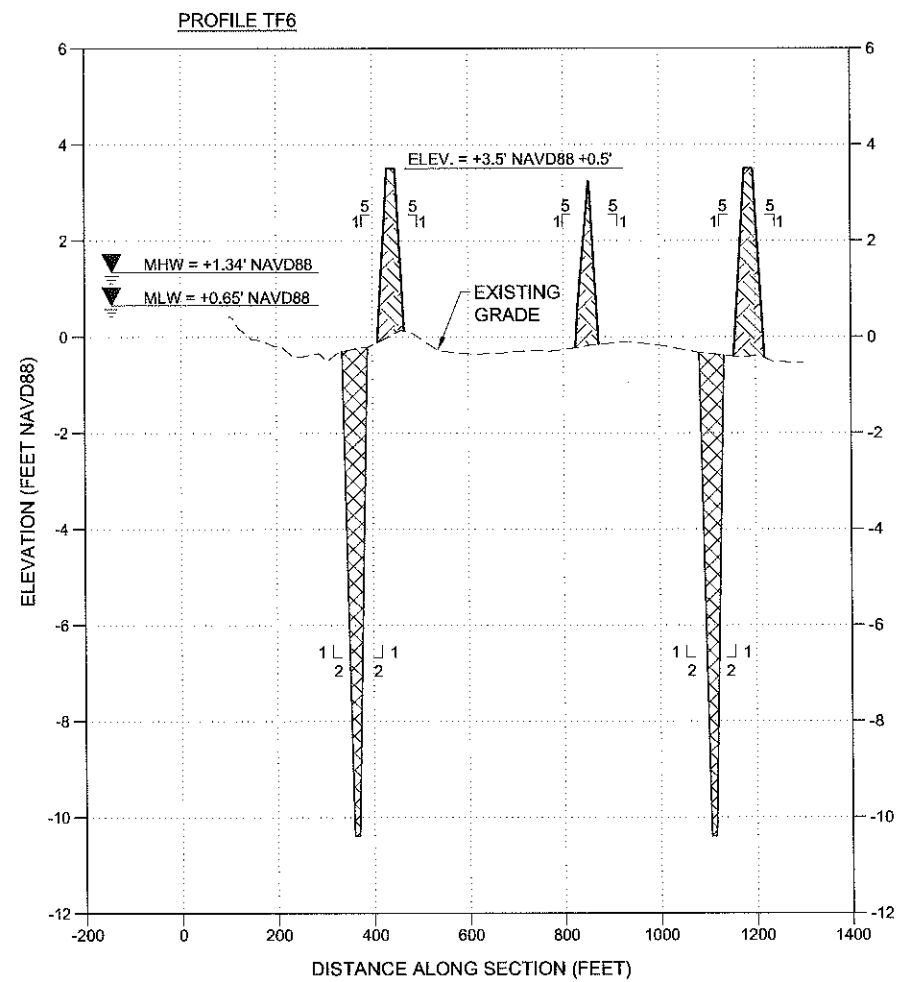
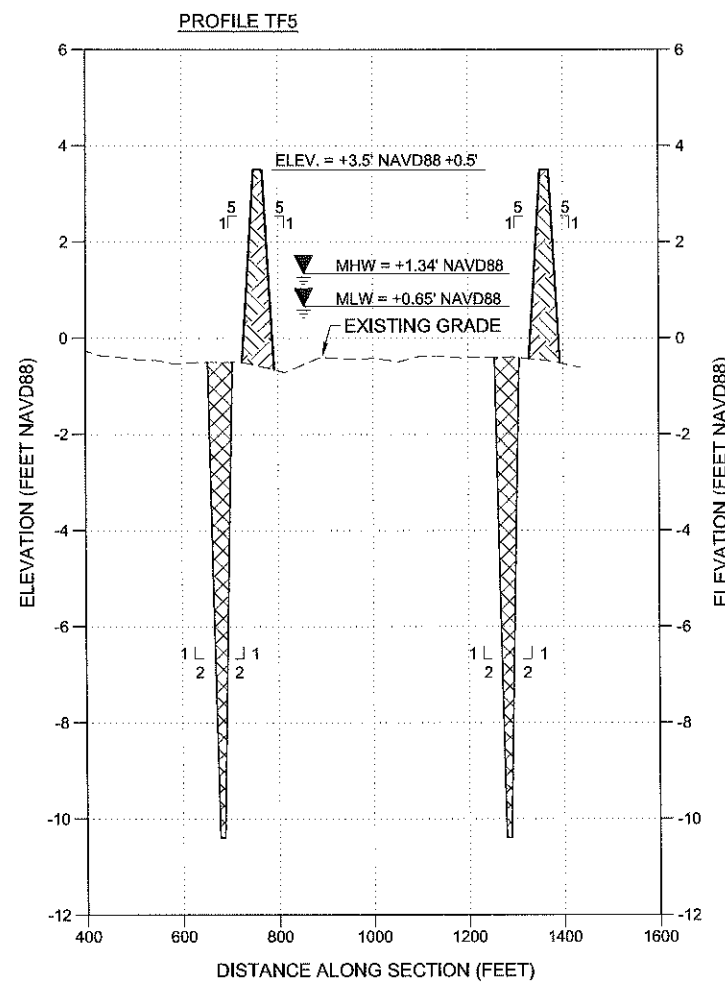

LEGEND:

- EARTHEN TERRACE ELEV. +3.5'
- EARTHEN TERRACE BORROW AREA ELEV. -10.4' (MAX)

NOTES:

1. ELEVATIONS SHOWN HEREON ARE IN FEET BASED ON NAVD 1988.
2. SURVEY ELEVATIONS SHOWN ON THE PLANS ARE FROM SURVEY DATA COLLECTED IN AUGUST AND SEPTEMBER 2012 BY LONNIE G. HARPER AND ASSOCIATES.
3. LAY OUT ALL FILL AREAS BY ALIGNMENT TABLE ON SHEET 4.
4. DISTANCES ARE ALONG SECTION LINE.
5. LOCATIONS OF PIPELINES ARE APPROXIMATE. CONTRACTOR SHALL VERIFY EXACT LOCATION PRIOR TO EXCAVATION.
6. NO EXCAVATION IS ALLOWED WITHIN 50 FEET OF A PIPELINE.
7. SEE SHEETS 16 AND 17 FOR TERRACE FIELD DETAILS.

REV.	DATE	DESCRIPTION	BY

CB&I COASTAL PLANNING & ENGINEERING, INC.
 2481 N.W. BOCA RATON BOULEVARD
 BOCA RATON, FLORIDA 33431

PH. (561) 391-8102
 FAX (561) 391-8116

C.O.A. FL #4028
 C.O.A. LA #2631
 www.CBI.COM

COASTAL PROTECTION AND RESTORATION AUTHORITY

450 LAUREL STREET
 BATON ROUGE, LOUISIANA 70801

DRAWN BY: GK

DESIGNED BY: CP

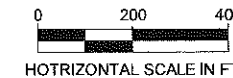
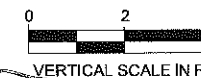
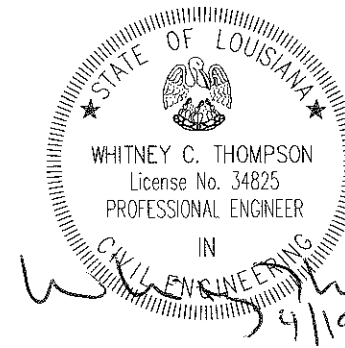

OYSTER BAYOU MARSH RESTORATION PROJECT

STATE PROJECT NUMBER: CS-59

FEDERAL PROJECT NUMBER: CS-59

APPROVED BY: WT

TERRACE FIELD CONSTRUCTION PROFILES

DATE: APRIL 13, 2016

SHEET 55 OF 69

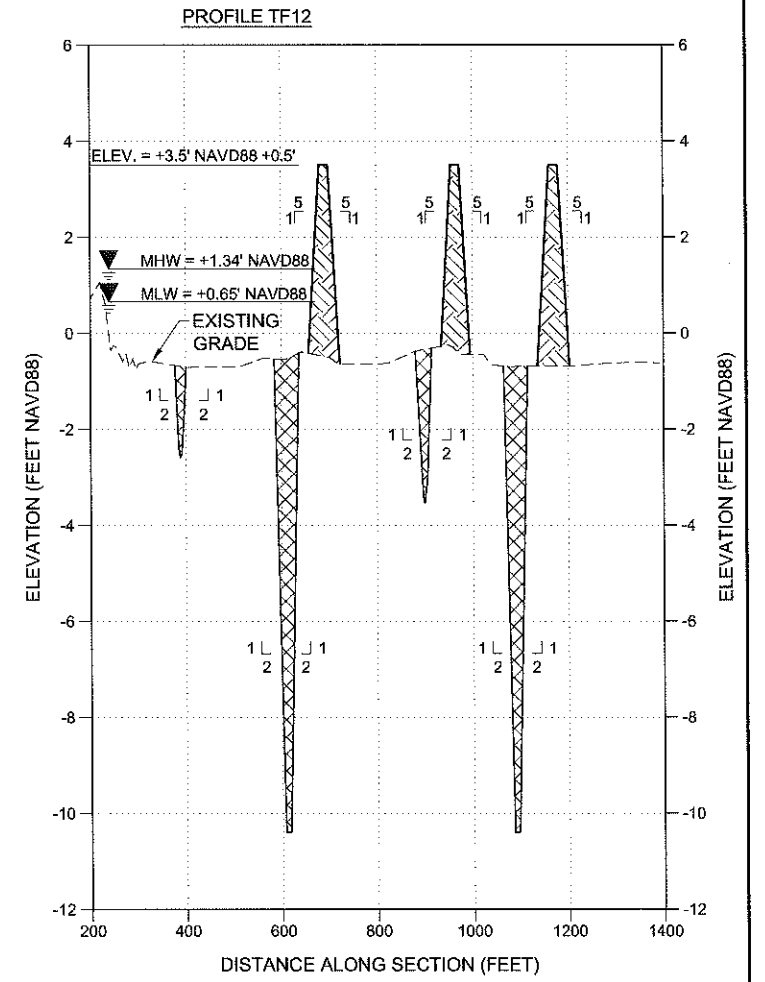
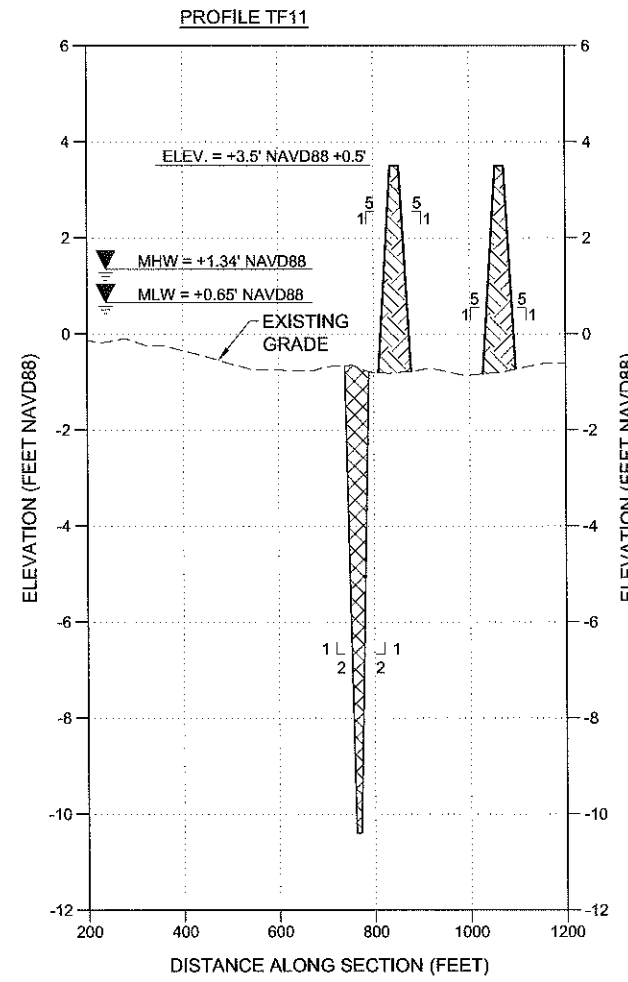
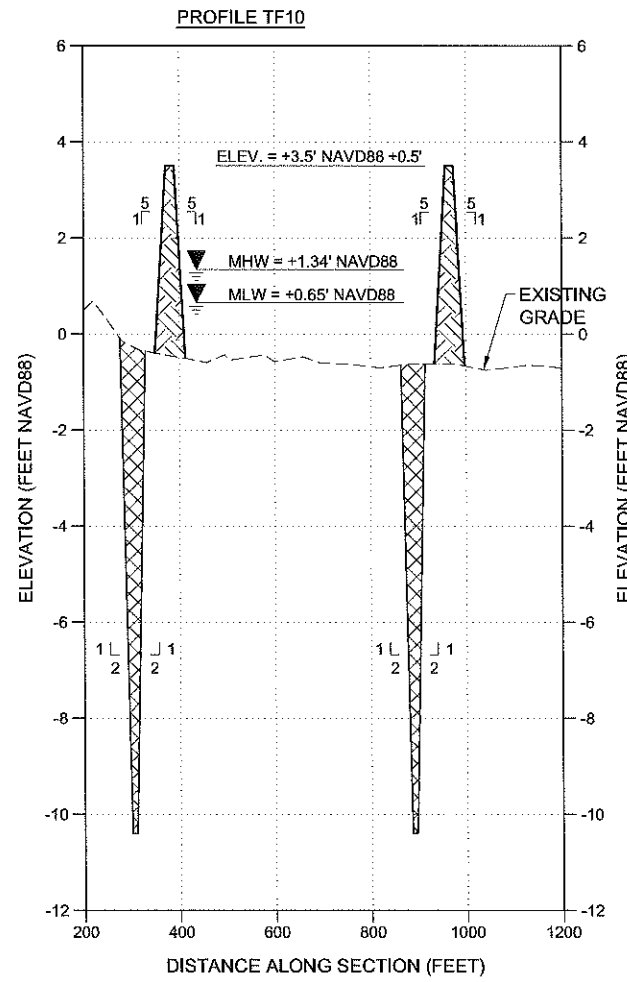
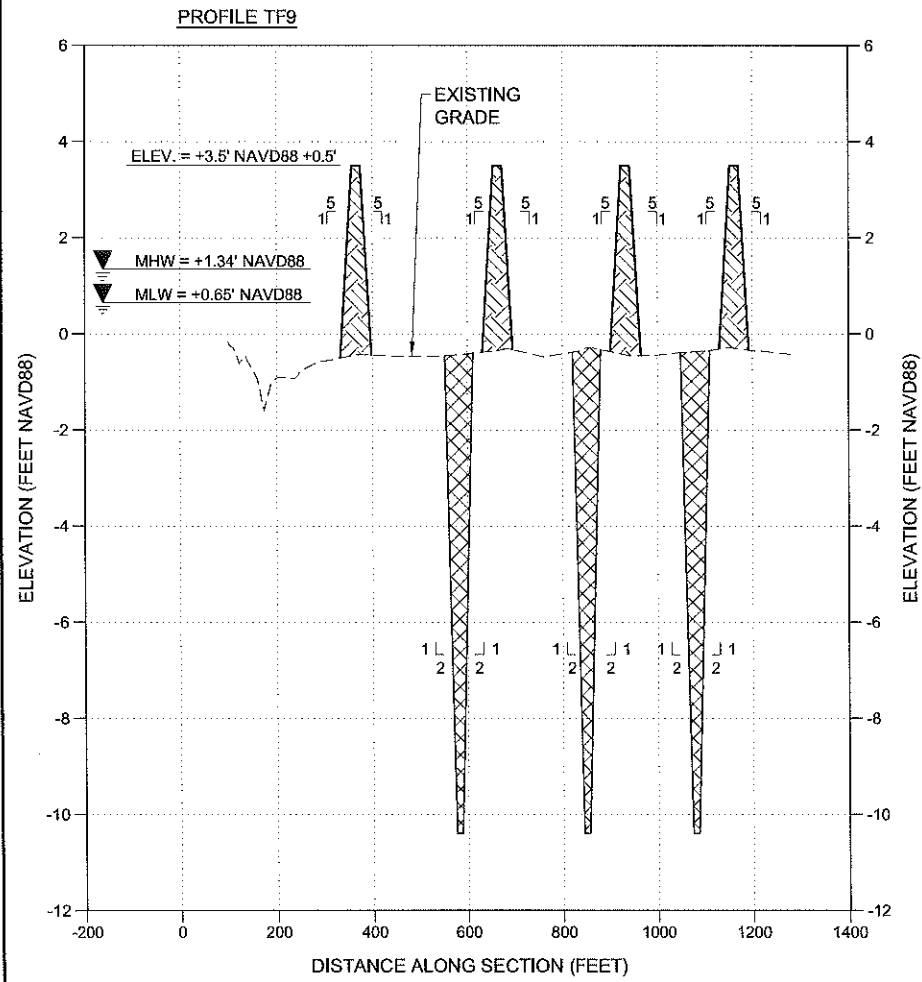

LEGEND:

- EARTHEN TERRACE ELEV. +3.5'
- EARTHEN TERRACE BORROW AREA ELEV. -10.4' (MAX)

NOTES:

1. ELEVATIONS SHOWN HEREON ARE IN FEET BASED ON NAVD 1988.
2. SURVEY ELEVATIONS SHOWN ON THE PLANS ARE FROM SURVEY DATA COLLECTED IN AUGUST AND SEPTEMBER 2012 BY LONNIE G. HARPER AND ASSOCIATES.
3. LAY OUT ALL FILL AREAS BY ALIGNMENT TABLE ON SHEET 4.
4. DISTANCES ARE ALONG SECTION LINE.
5. LOCATIONS OF PIPELINES ARE APPROXIMATE. CONTRACTOR SHALL VERIFY EXACT LOCATION PRIOR TO EXCAVATION.
6. NO EXCAVATION IS ALLOWED WITHIN 50 FEET OF A PIPELINE.
7. SEE SHEETS 16 AND 17 FOR TERRACE FIELD DETAILS.

REV.	DATE	DESCRIPTION	BY

CB&I COASTAL PLANNING & ENGINEERING, INC.
 2481 N.W. BOCA RATON BOULEVARD
 BOCA RATON, FLORIDA 33431
 PH. (561) 391-8102
 FAX (561) 391-9116
 C.O.A. FL #4028
 C.O.A. LA #2531
 www.CBI.COM

COASTAL PROTECTION AND RESTORATION AUTHORITY
 450 LAUREL STREET
 BATON ROUGE, LOUISIANA 70801
 DRAWN BY: GK
 DESIGNED BY: CP

OYSTER BAYOU MARSH RESTORATION PROJECT
 STATE PROJECT NUMBER: CS-59
 FEDERAL PROJECT NUMBER: CS-59
 APPROVED BY: WT

TERRACE FIELD CONSTRUCTION PROFILES
 DATE: APRIL 13, 2016
 SHEET 56 OF 69

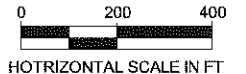
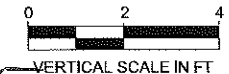
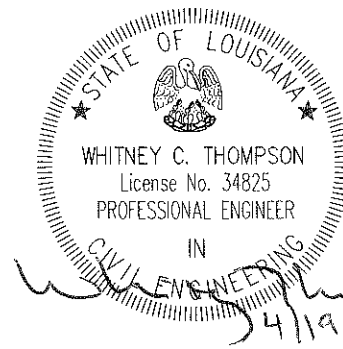

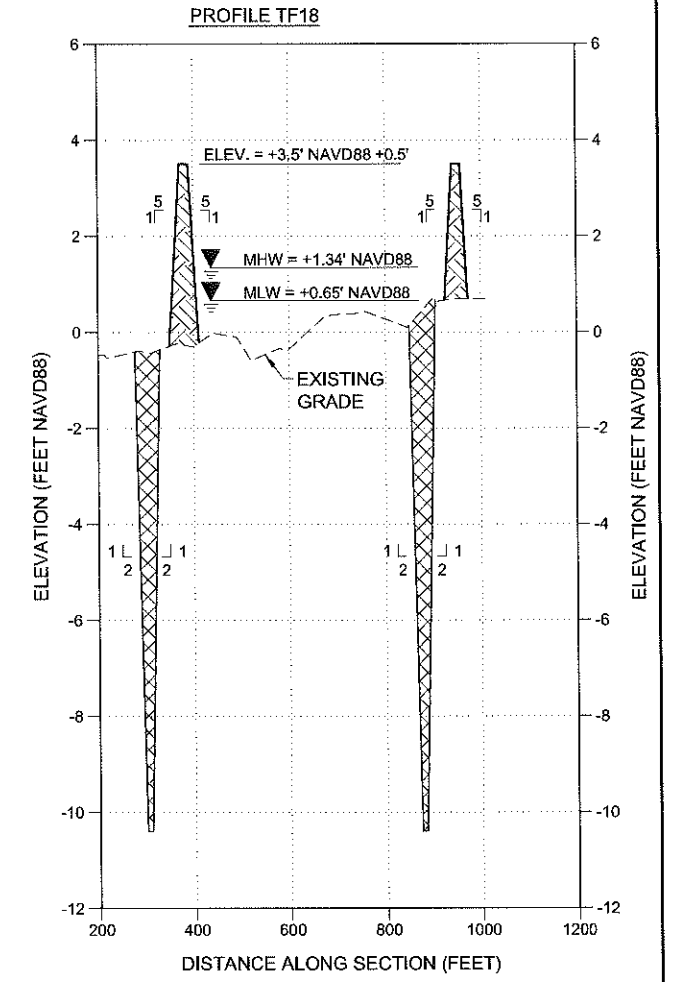
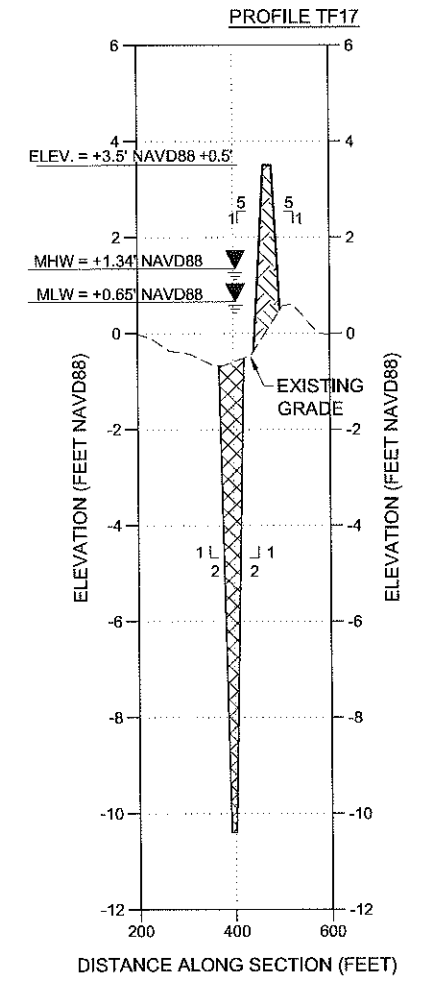
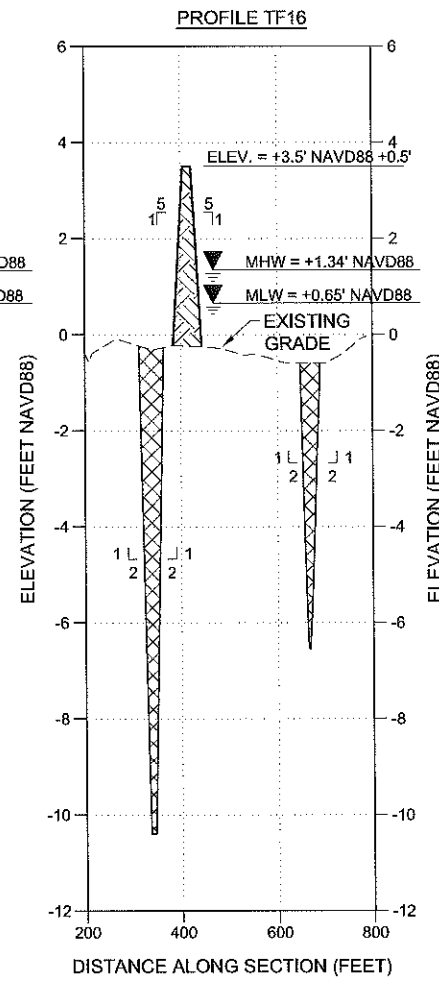
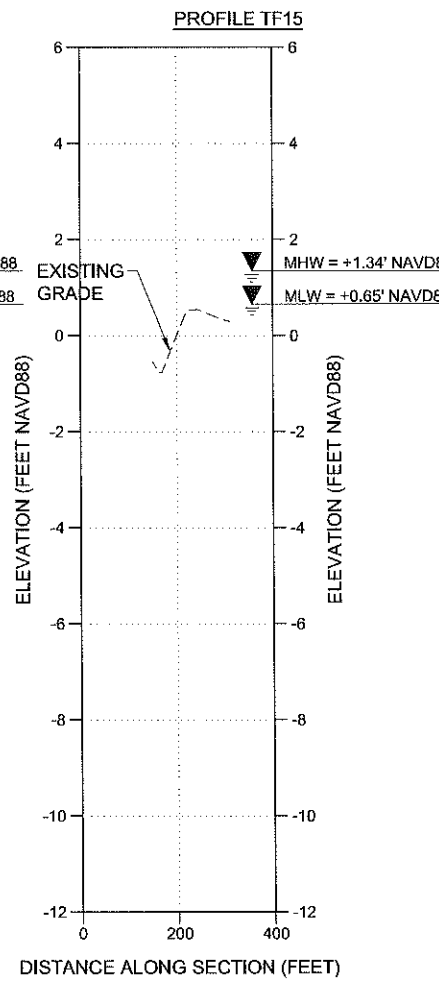
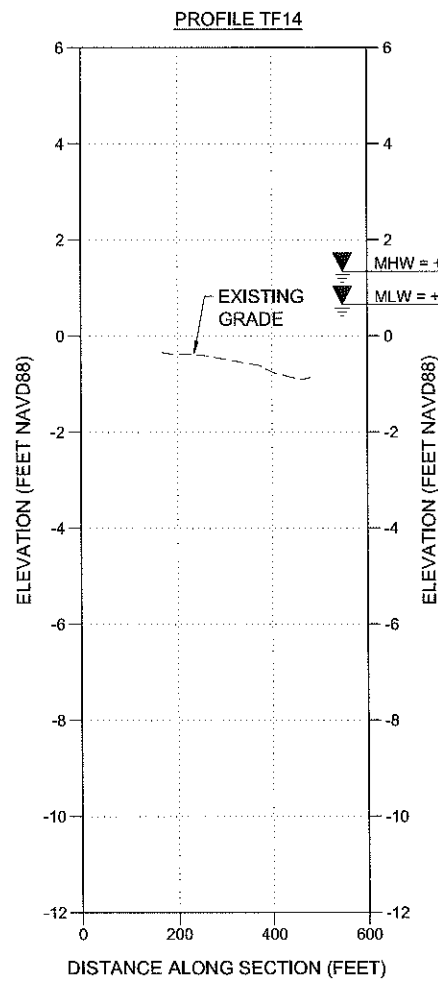
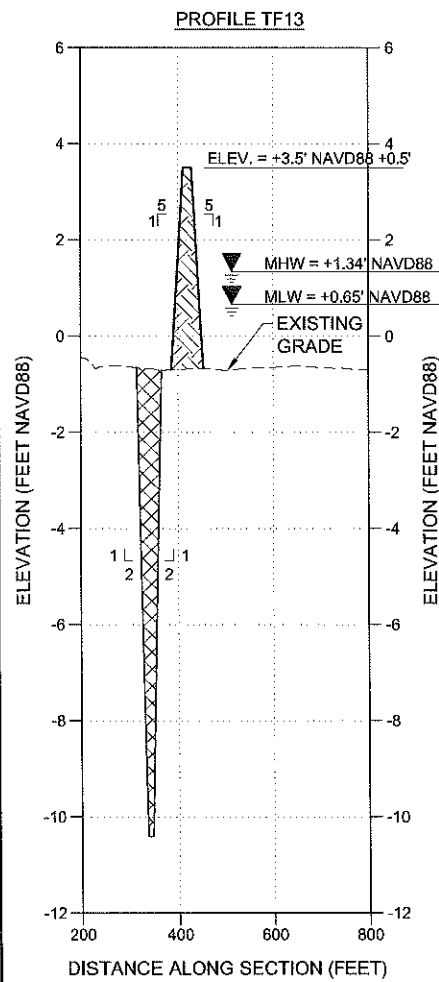

LEGEND:

- EARTHEN TERRACE ELEV. +3.5'
- EARTHEN TERRACE BORROW AREA ELEV. -10.4' (MAX)

NOTES:

1. ELEVATIONS SHOWN HEREON ARE IN FEET BASED ON NAVD 1988.
2. SURVEY ELEVATIONS SHOWN ON THE PLANS ARE FROM SURVEY DATA COLLECTED IN AUGUST AND SEPTEMBER 2012 BY LONNIE G. HARPER AND ASSOCIATES.
3. LAY OUT ALL FILL AREAS BY ALIGNMENT TABLE ON SHEET 4.
4. DISTANCES ARE ALONG SECTION LINE.
5. LOCATIONS OF PIPELINES ARE APPROXIMATE. CONTRACTOR SHALL VERIFY EXACT LOCATION PRIOR TO EXCAVATION.
6. NO EXCAVATION IS ALLOWED WITHIN 50 FEET OF A PIPELINE.
7. SEE SHEETS 16 AND 17 FOR TERRACE FIELD DETAILS.

REV.	DATE	DESCRIPTION	BY

CB&I COASTAL PLANNING & ENGINEERING, INC.
 2481 N.W. BOCA RATON BOULEVARD
 BOCA RATON, FLORIDA 33431

PH. (561) 391-8102
 FAX (561) 391-8116

C.O.A. FL #4028
 C.O.A. LA. #2531
 www.CBI.COM

COASTAL PROTECTION AND RESTORATION AUTHORITY

450 LAUREL STREET
 BATON ROUGE, LOUISIANA 70801

DRAWN BY: GK

DESIGNED BY: CP

OYSTER BAYOU MARSH RESTORATION PROJECT

STATE PROJECT NUMBER: CS-59

FEDERAL PROJECT NUMBER: CS-59

APPROVED BY: WT

TERRACE FIELD CONSTRUCTION PROFILES

DATE: APRIL 13, 2016

SHEET 57 OF 69

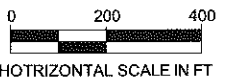
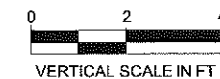
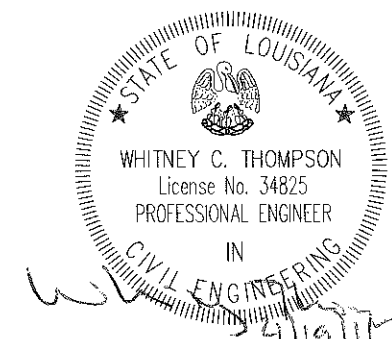

ACCESS ROUTE NO.	BEGINNING		ENDING	
	NORTHING	EASTING	NORTHING	EASTING
CL 1	467713.69	2618320.27	473722.18	2618107.09
CL 2	472296.49	2618448.63	472461.97	2618861.6
CL 3	471230.12	2623602.71	477615.09	2626706.36
CL 4	466915.85	2626375.68	477223.57	2626044.61

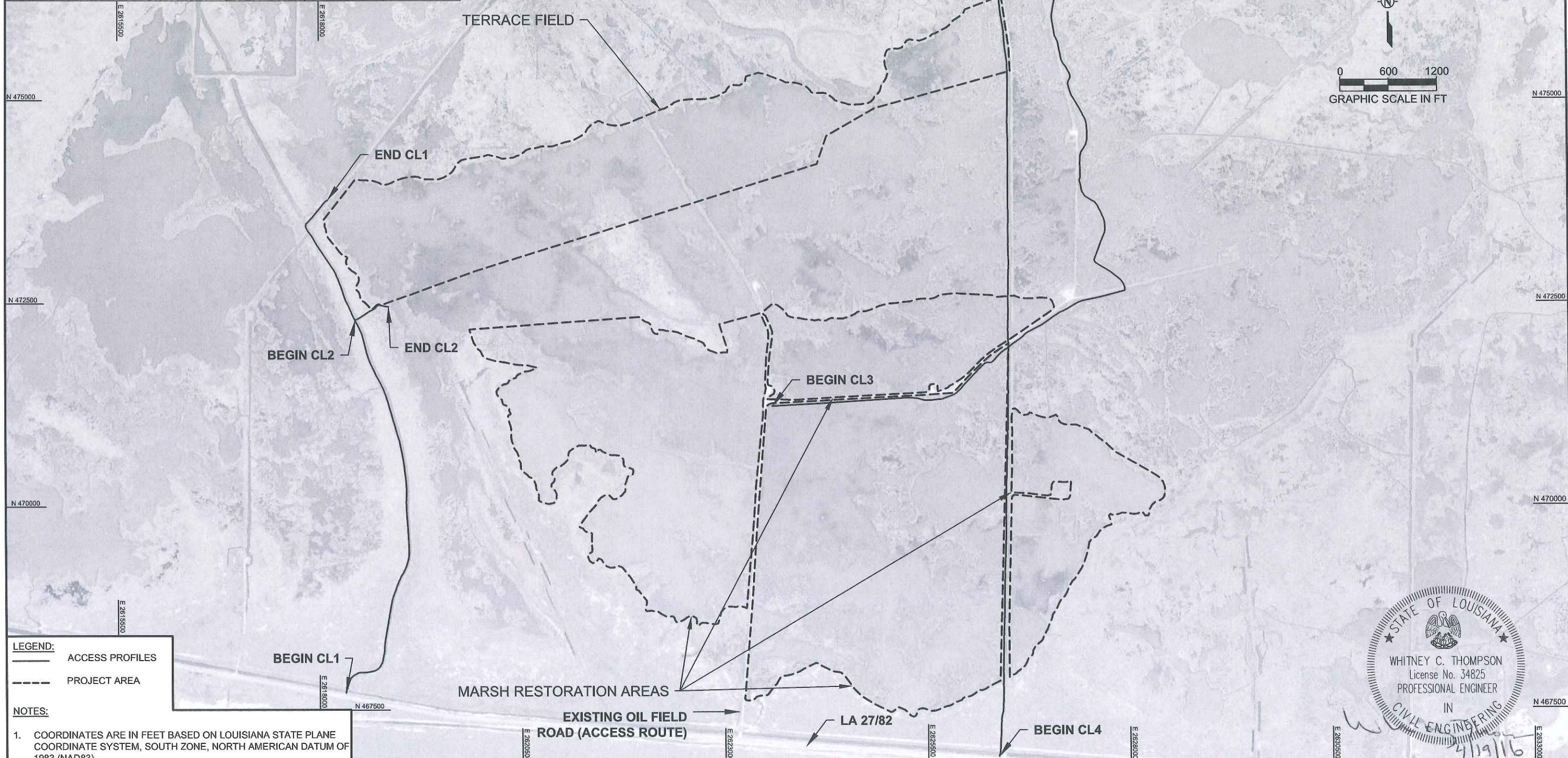

LEGEND:
 — ACCESS PROFILES
 - - - PROJECT AREA

NOTES:

- COORDINATES ARE IN FEET BASED ON LOUISIANA STATE PLANE COORDINATE SYSTEM, SOUTH ZONE, NORTH AMERICAN DATUM OF 1983 (NAD83).
- SURVEY ELEVATIONS SHOWN ON THE PLANS ARE FROM SURVEY DATA COLLECTED IN AUGUST AND SEPTEMBER 2012 BY LONNIE G. HARPER AND ASSOCIATES.
- DATE OF AERIAL IMAGERY: 2013
- THE CONTRACTOR SHALL BE RESPONSIBLE FOR NAVIGATING FROM A NAVIGABLE WATER BODY TO THE PROJECT AREA. THE CONTRACTOR SHALL ALSO BE RESPONSIBLE FOR NAVIGATING WITHIN THE LIMITS OF THE PROJECT PLAN AREA. NO ACCESS DREDGING IS PERMITTED.

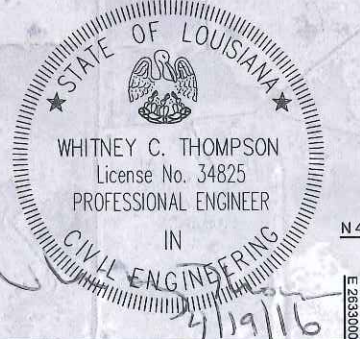

CB&I COASTAL PLANNING & ENGINEERING, INC. 2481 N.W. BOCA RATON BOULEVARD BOCA RATON, FLORIDA 33431 PH. (561) 391-8102 FAX (561) 391-8116 C.O.A. FL. #4028 C.O.A. LA. #2531 www.CBI.COM		COASTAL PROTECTION AND RESTORATION AUTHORITY 450 LAUREL STREET BATON ROUGE, LOUISIANA 70801 DRAWN BY: GK DESIGNED BY: CP		OYSTER BAYOU MARSH RESTORATION PROJECT STATE PROJECT NUMBER: CS-59 FEDERAL PROJECT NUMBER: CS-59 APPROVED BY: WT		ACCESS ROUTES PLAN VIEW DATE: APRIL 13, 2016 SHEET 58 OF 69	
--	--	---	--	--	--	--	--

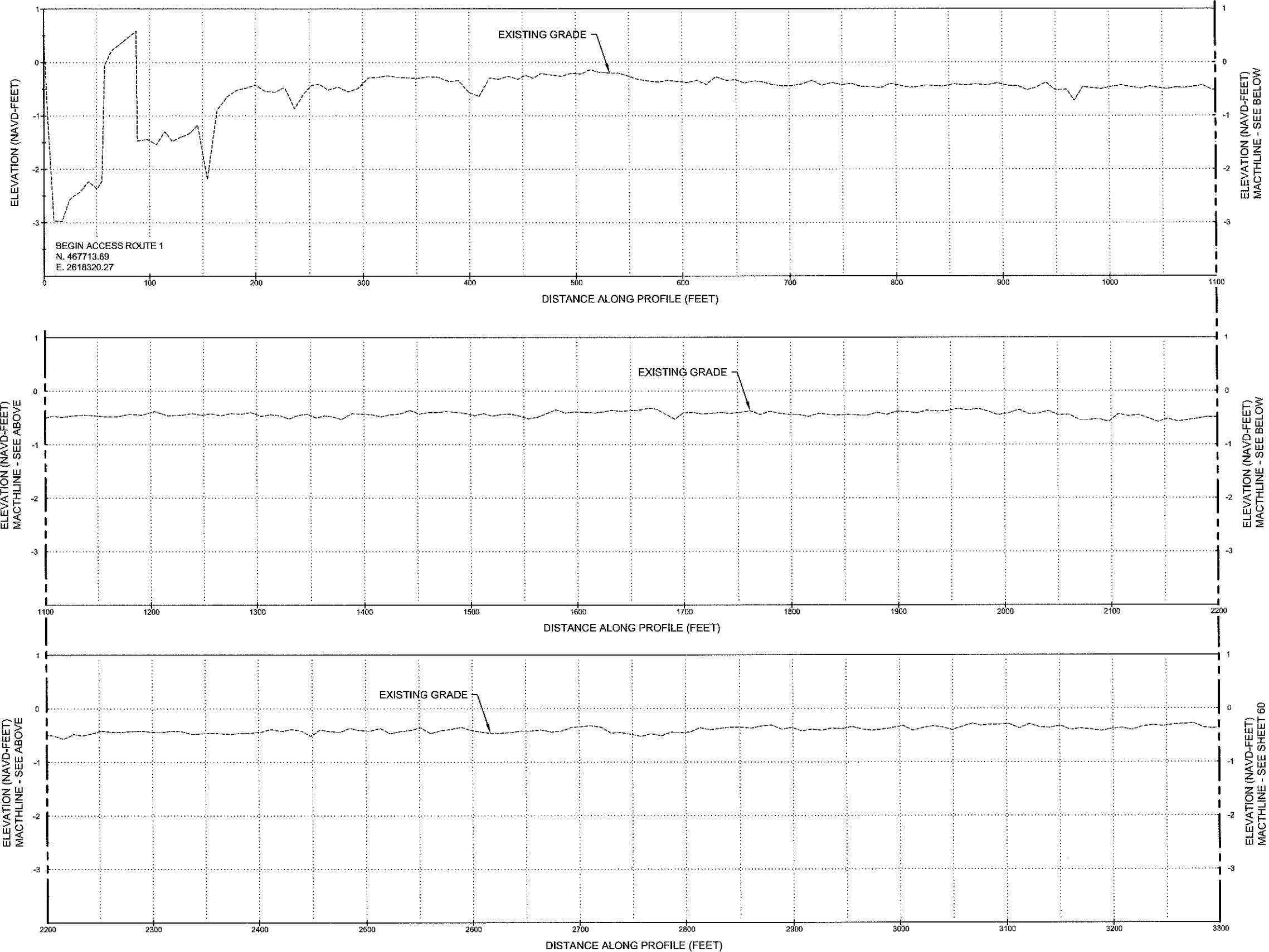

STATE OF LOUISIANA
 ★  ★
 WHITNEY C. THOMPSON
 License No. 34825
 PROFESSIONAL ENGINEER
 IN
 CIVIL ENGINEERING
Whitney C. Thompson
 4/19/16

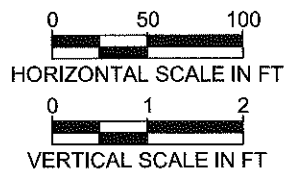

NOTES:

1. SURVEY ELEVATIONS SHOWN ON THE PLANS ARE FROM SURVEY DATA COLLECTED IN AUGUST AND SEPTEMBER 2012 BY LONNIE G. HARPER AND ASSOCIATES.
2. THE CONTRACTOR SHALL BE RESPONSIBLE FOR NAVIGATING FROM A NAVIGABLE WATER BODY TO THE PROJECT AREA. THE CONTRACTOR SHALL ALSO BE RESPONSIBLE FOR NAVIGATING WITHIN THE LIMITS OF THE PROJECT PLAN AREA. NO ACCESS DREDGING IS PERMITTED.

REV.	DATE	DESCRIPTION	BY

CB&I COASTAL PLANNING & ENGINEERING, INC.
 2481 N.W. BOCA RATON BOULEVARD
 BOCA RATON, FLORIDA 33431
 PH. (561) 391-8102
 FAX (561) 391-8116
 C.O.A. FL. #4028
 C.O.A. LA. #2531
 www.CBI.COM

COASTAL PROTECTION AND RESTORATION AUTHORITY
 450 LAUREL STREET
 BATON ROUGE, LOUISIANA 70801
 DRAWN BY: GK
 DESIGNED BY: CP

OYSTER BAYOU MARSH RESTORATION PROJECT
 STATE PROJECT NUMBER: CS-59
 FEDERAL PROJECT NUMBER: CS-59
 APPROVED BY: WT

ACCESS ROUTE "CL1"
 DATE: APRIL 13, 2016
 SHEET 59 OF 69

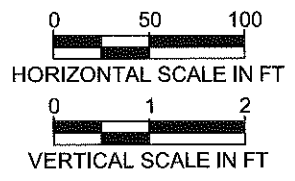
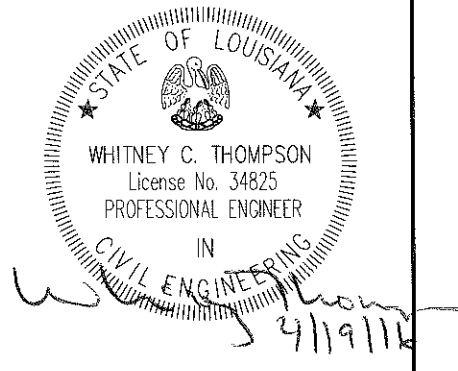
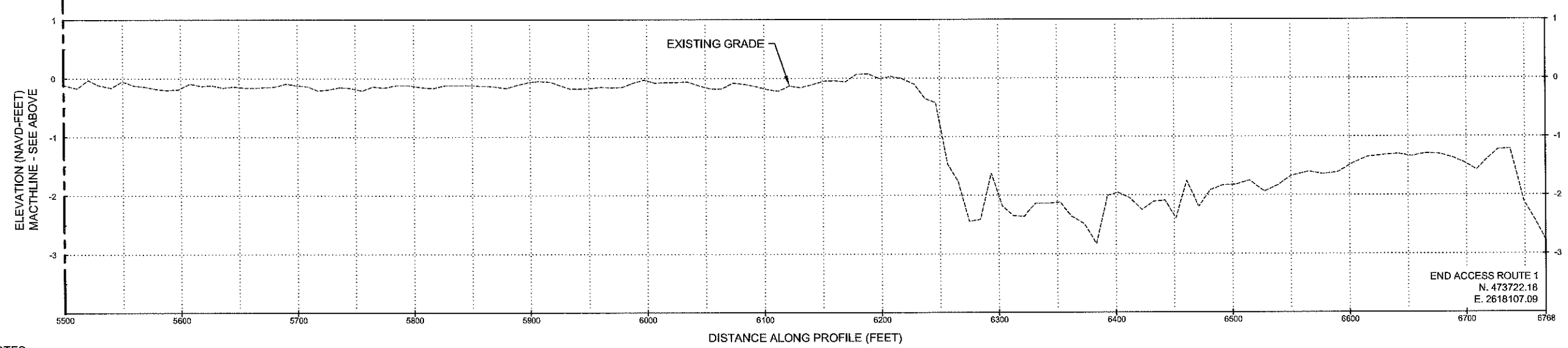
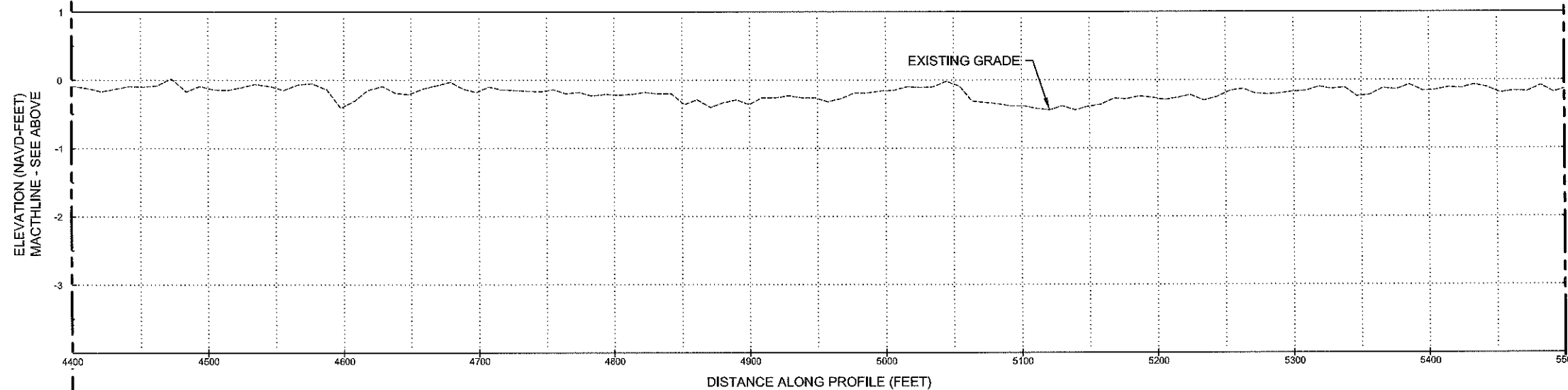
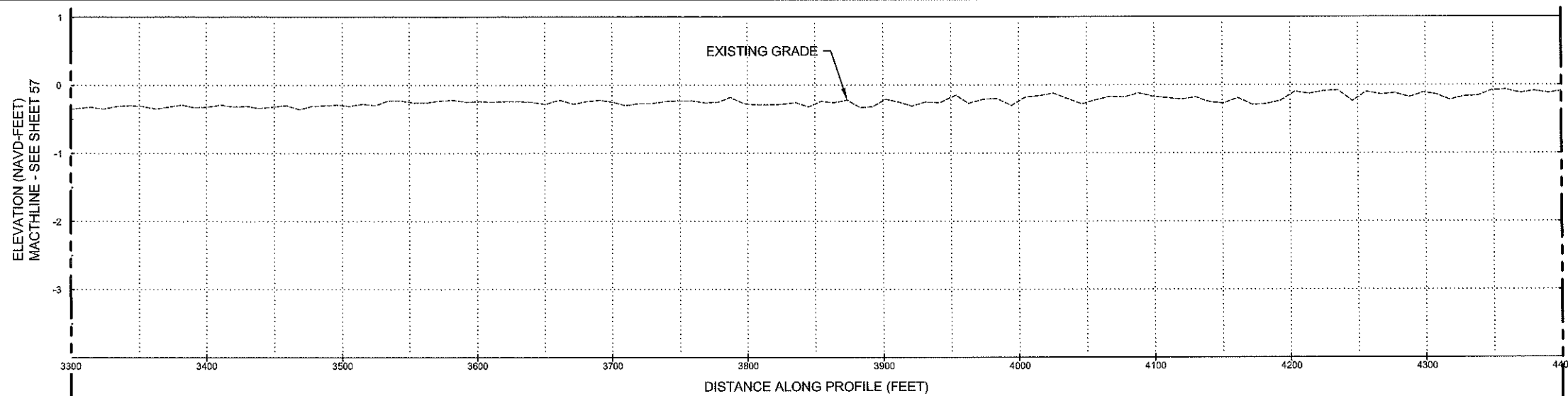

NOTES:

1. SURVEY ELEVATIONS SHOWN ON THE PLANS ARE FROM SURVEY DATA COLLECTED IN AUGUST AND SEPTEMBER 2012 BY LONNIE G. HARPER AND ASSOCIATES.
2. THE CONTRACTOR SHALL BE RESPONSIBLE FOR NAVIGATING FROM A NAVIGABLE WATER BODY TO THE PROJECT AREA. THE CONTRACTOR SHALL ALSO BE RESPONSIBLE FOR NAVIGATING WITHIN THE LIMITS OF THE PROJECT PLAN AREA. NO ACCESS DREDGING IS PERMITTED.

REV.	DATE	DESCRIPTION	BY

CB&I COASTAL PLANNING & ENGINEERING, INC.
 2481 N.W. BOCA RATON BOULEVARD
 BOCA RATON, FLORIDA 33431
 PH. (561) 391-8102
 FAX (561) 391-9116
 C.O.A. FL. #4028
 C.O.A. LA. #2531
 www.CBI.COM

COASTAL PROTECTION AND RESTORATION AUTHORITY
 450 LAUREL STREET
 BATON ROUGE, LOUISIANA 70801
 DRAWN BY: GK
 DESIGNED BY: CP

OYSTER BAYOU MARSH RESTORATION PROJECT
 STATE PROJECT NUMBER: CS-59
 FEDERAL PROJECT NUMBER: CS-59
 APPROVED BY: WT

ACCESS ROUTE "CL1"
 DATE: APRIL 13, 2016
 SHEET 60 OF 69

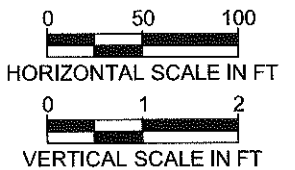
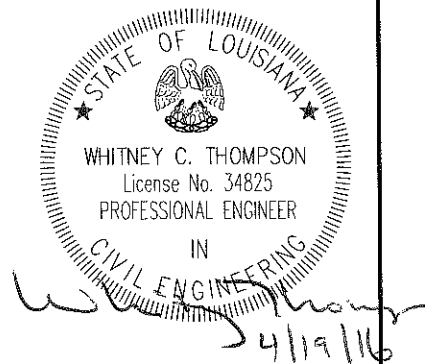
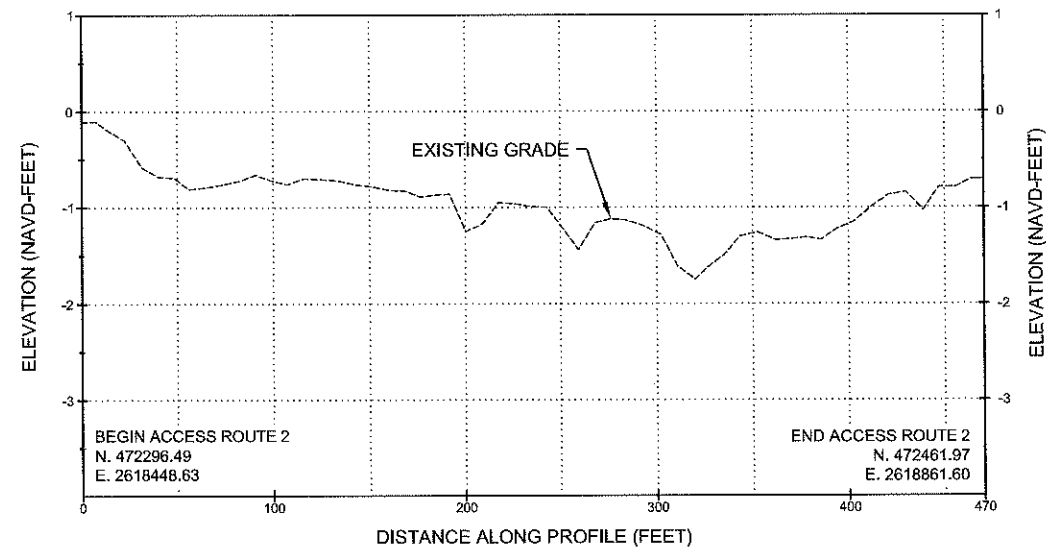

NOTES:

1. SURVEY ELEVATIONS SHOWN ON THE PLANS ARE FROM SURVEY DATA COLLECTED IN AUGUST AND SEPTEMBER 2012 BY LONNIE G. HARPER AND ASSOCIATES.
2. THE CONTRACTOR SHALL BE RESPONSIBLE FOR NAVIGATING FROM A NAVIGABLE WATER BODY TO THE PROJECT AREA. THE CONTRACTOR SHALL ALSO BE RESPONSIBLE FOR NAVIGATING WITHIN THE LIMITS OF THE PROJECT PLAN AREA. NO ACCESS DREDGING IS PERMITTED.

REV.	DATE	DESCRIPTION	BY	CB&I COASTAL PLANNING & ENGINEERING, INC. 2481 N.W. BOCA RATON BOULEVARD BOCA RATON, FLORIDA 33431 PH. (561) 391-8102 FAX (561) 391-9116 C.O.A. FL. #4028 C.O.A. LA. #2531 www.CBI.COM	COASTAL PROTECTION AND RESTORATION AUTHORITY 450 LAUREL STREET BATON ROUGE, LOUISIANA 70801	OYSTER BAYOU MARSH RESTORATION PROJECT	ACCESS ROUTE "CL2"
						STATE PROJECT NUMBER: CS-59	DATE: APRIL 13, 2016
						FEDERAL PROJECT NUMBER: CS-59	SHEET 61 OF 69
				DRAWN BY: GK	DESIGNED BY: CP	APPROVED BY: WT	

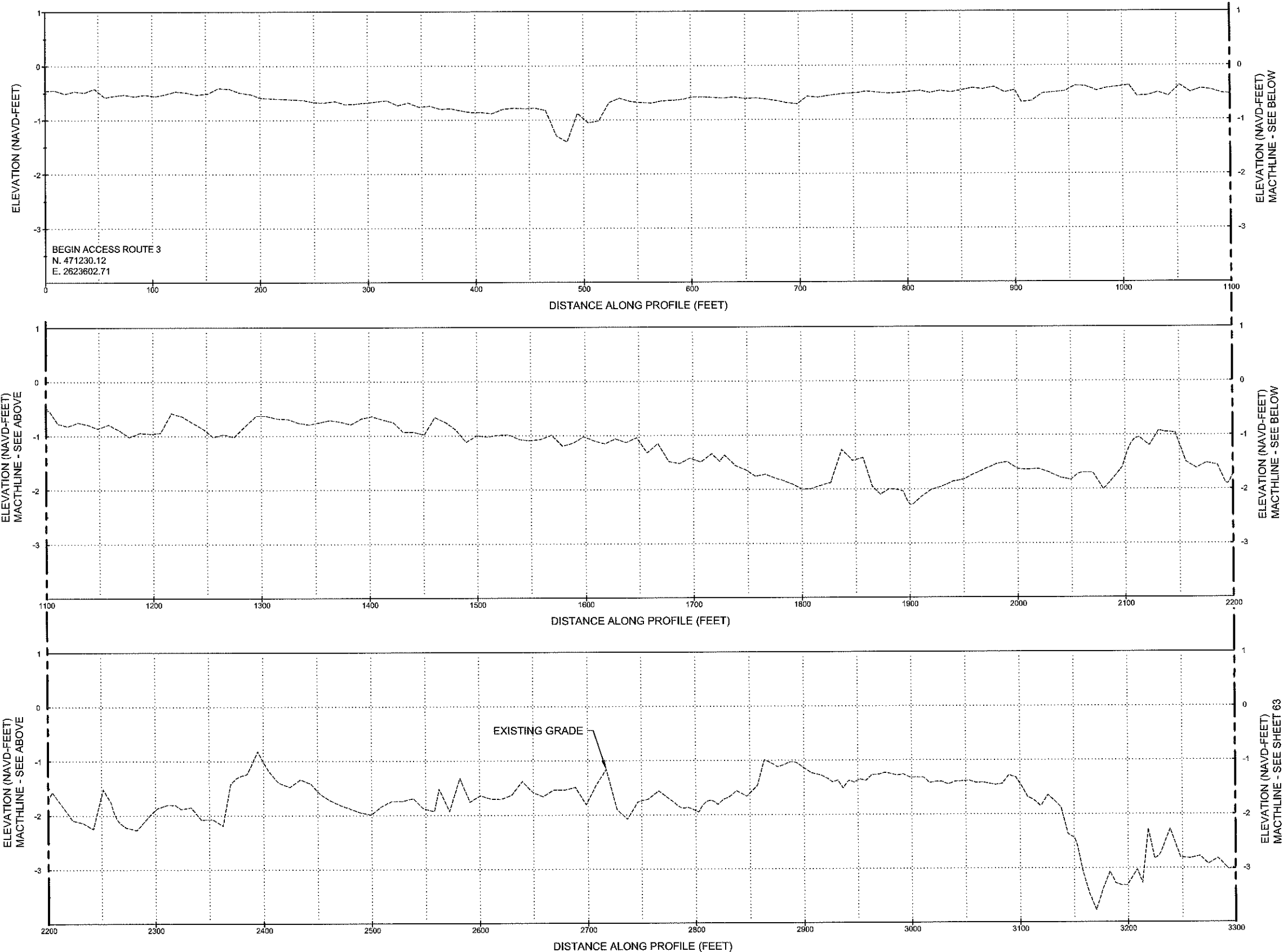

BEGIN ACCESS ROUTE 3
N. 471230.12
E. 2623602.71

EXISTING GRADE

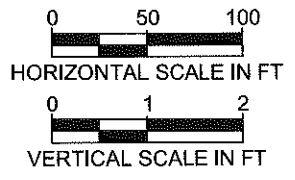
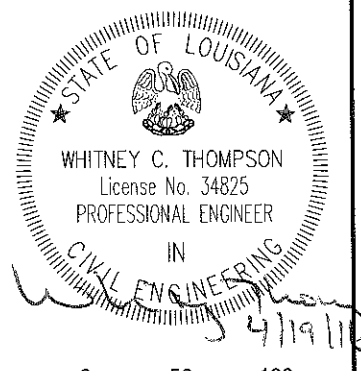

NOTES:

1. SURVEY ELEVATIONS SHOWN ON THE PLANS ARE FROM SURVEY DATA COLLECTED IN AUGUST AND SEPTEMBER 2012 BY LONNIE G. HARPER AND ASSOCIATES.
2. THE CONTRACTOR SHALL BE RESPONSIBLE FOR NAVIGATING FROM A NAVIGABLE WATER BODY TO THE PROJECT AREA. THE CONTRACTOR SHALL ALSO BE RESPONSIBLE FOR NAVIGATING WITHIN THE LIMITS OF THE PROJECT PLAN AREA. NO ACCESS DREDGING IS PERMITTED.

REV.	DATE	DESCRIPTION	BY

CB&I COASTAL PLANNING & ENGINEERING, INC.
2481 N.W. BOCA RATON BOULEVARD
BOCA RATON, FLORIDA 33431

PH. (561) 391-8102
FAX (561) 391-8116

C.O.A. FL. #4028
C.O.A. LA. #2531
www.CBI.COM

COASTAL PROTECTION AND RESTORATION AUTHORITY
450 LAUREL STREET
BATON ROUGE, LOUISIANA 70801

DRAWN BY: GK DESIGNED BY: CP

OYSTER BAYOU MARSH RESTORATION PROJECT

STATE PROJECT NUMBER: CS-59
FEDERAL PROJECT NUMBER: CS-59

APPROVED BY: WT

ACCESS ROUTE "CL3"

DATE: APRIL 13, 2016
SHEET 62 OF 69

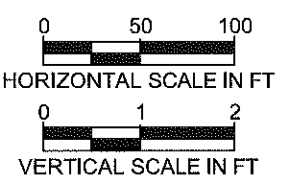
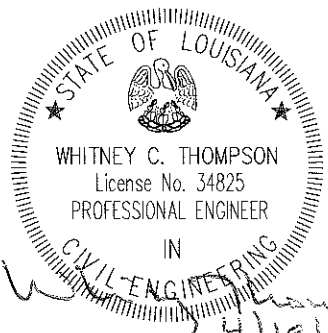
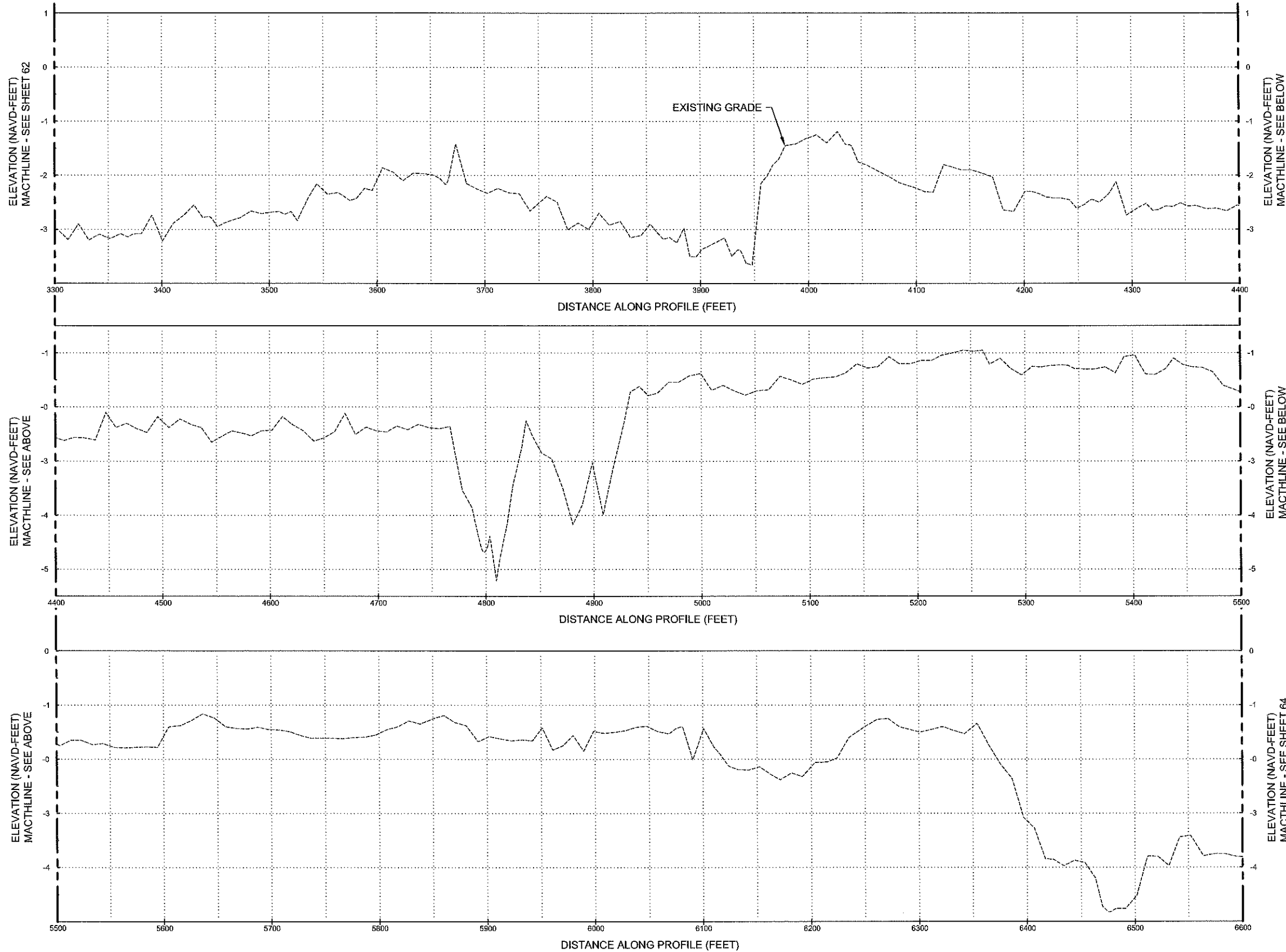

NOTES:

1. SURVEY ELEVATIONS SHOWN ON THE PLANS ARE FROM SURVEY DATA COLLECTED IN AUGUST AND SEPTEMBER 2012 BY LONNIE G. HARPER AND ASSOCIATES.
2. THE CONTRACTOR SHALL BE RESPONSIBLE FOR NAVIGATING FROM A NAVIGABLE WATER BODY TO THE PROJECT AREA. THE CONTRACTOR SHALL ALSO BE RESPONSIBLE FOR NAVIGATING WITHIN THE LIMITS OF THE PROJECT PLAN AREA. NO ACCESS DREDGING IS PERMITTED.

REV.	DATE	DESCRIPTION	BY

CB&I COASTAL PLANNING & ENGINEERING, INC.
 2481 N.W. BOCA RATON BOULEVARD
 BOCA RATON, FLORIDA 33431
 PH. (561) 391-8102
 FAX (561) 391-8116
 C.O.A. FL. #4028
 C.O.A. LA. #2531
 www.CBI.COM

COASTAL PROTECTION AND RESTORATION AUTHORITY
 450 LAUREL STREET
 BATON ROUGE, LOUISIANA 70801
 DRAWN BY: GK
 DESIGNED BY: CP

OYSTER BAYOU MARSH RESTORATION PROJECT
 STATE PROJECT NUMBER: CS-59
 FEDERAL PROJECT NUMBER: CS-59
 APPROVED BY: WT

ACCESS ROUTE "CL3"
 DATE: APRIL 13, 2016
 SHEET 63 OF 69

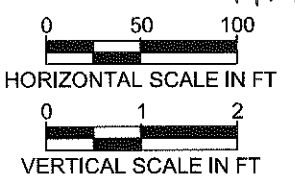
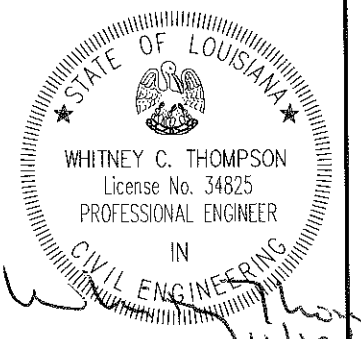
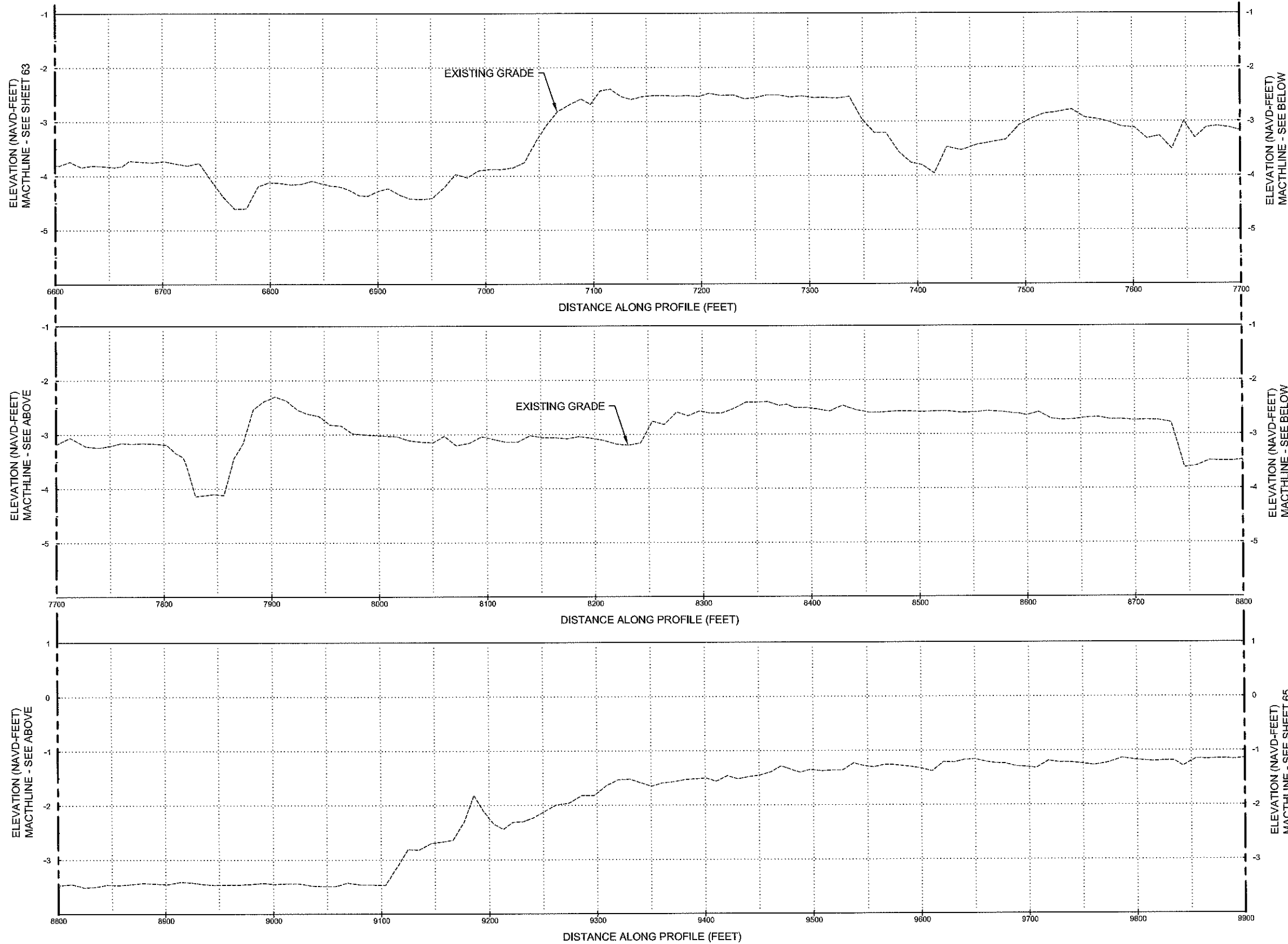

NOTES:

1. SURVEY ELEVATIONS SHOWN ON THE PLANS ARE FROM SURVEY DATA COLLECTED IN AUGUST AND SEPTEMBER 2012 BY LONNIE G. HARPER AND ASSOCIATES.
2. THE CONTRACTOR SHALL BE RESPONSIBLE FOR NAVIGATING FROM A NAVIGABLE WATER BODY TO THE PROJECT AREA. THE CONTRACTOR SHALL ALSO BE RESPONSIBLE FOR NAVIGATING WITHIN THE LIMITS OF THE PROJECT PLAN AREA. NO ACCESS DREDGING IS PERMITTED.

REV.	DATE	DESCRIPTION	BY

CB&I COASTAL PLANNING & ENGINEERING, INC.
 2481 N.W. BOCA RATON BOULEVARD
 BOCA RATON, FLORIDA 33431
 PH. (561) 391-8102
 FAX (561) 391-9116
 C.O.A. FL. #4028
 C.O.A. LA. #2531
 www.CBICOM

COASTAL PROTECTION AND RESTORATION AUTHORITY
 450 LAUREL STREET
 BATON ROUGE, LOUISIANA 70801
 DRAWN BY: GK
 DESIGNED BY: CP

OYSTER BAYOU MARSH RESTORATION PROJECT
 STATE PROJECT NUMBER: CS-59
 FEDERAL PROJECT NUMBER: CS-59
 APPROVED BY: WT

ACCESS ROUTE "CL3"
 DATE: APRIL 13, 2016
 SHEET 64 OF 69

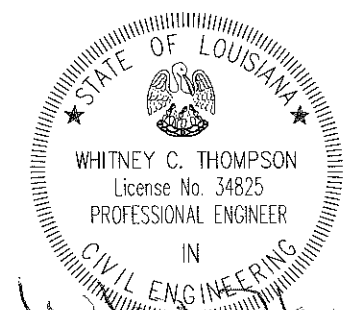
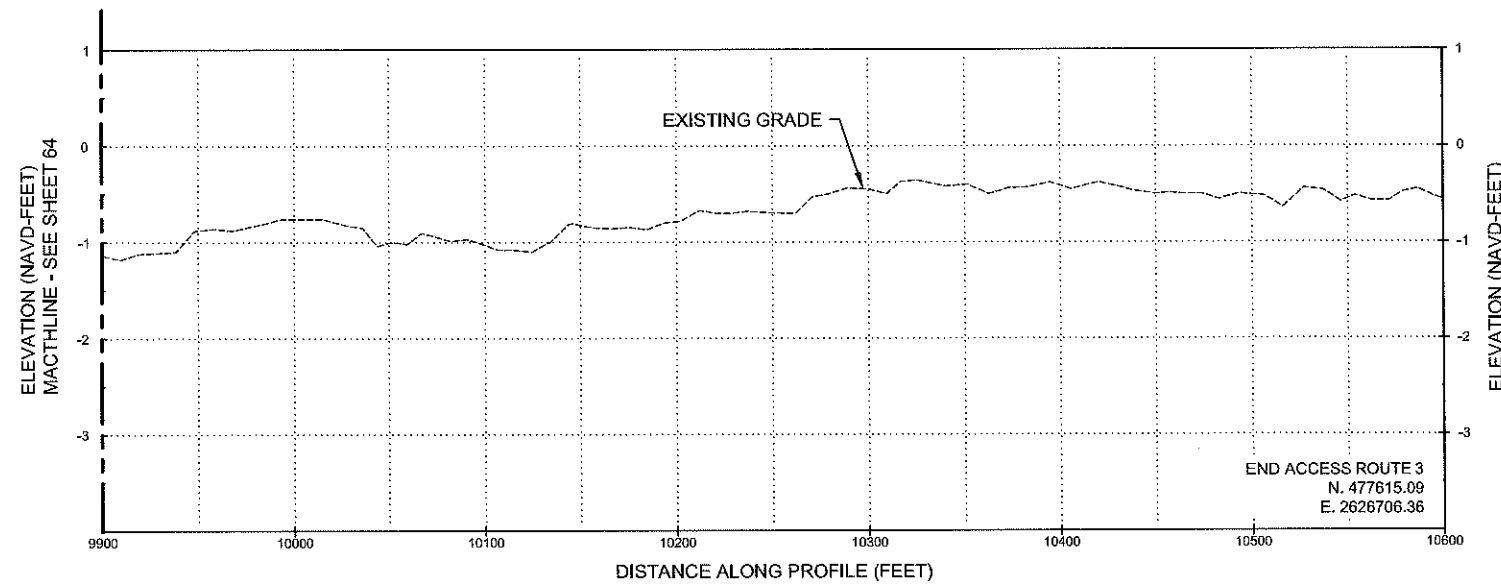

Whitney C. Thompson
4/19/16

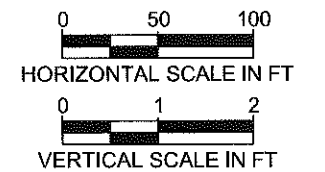

NOTES:

1. SURVEY ELEVATIONS SHOWN ON THE PLANS ARE FROM SURVEY DATA COLLECTED IN AUGUST AND SEPTEMBER 2012 BY LONNIE G. HARPER AND ASSOCIATES.
2. THE CONTRACTOR SHALL BE RESPONSIBLE FOR NAVIGATING FROM A NAVIGABLE WATER BODY TO THE PROJECT AREA. THE CONTRACTOR SHALL ALSO BE RESPONSIBLE FOR NAVIGATING WITHIN THE LIMITS OF THE PROJECT PLAN AREA. NO ACCESS DREDGING IS PERMITTED.

REV.	DATE	DESCRIPTION	BY

CB&I COASTAL PLANNING & ENGINEERING, INC.
 2481 N.W. BOCA RATON BOULEVARD
 BOCA RATON, FLORIDA 33431
 PH. (561) 391-8102
 FAX (561) 391-8116
 C.O.A. FL. #4028
 C.O.A. LA. #2531
 www.CBICOM

COASTAL PROTECTION AND RESTORATION AUTHORITY
 450 LAUREL STREET
 BATON ROUGE, LOUISIANA 70801
 DRAWN BY: GK
 DESIGNED BY: CP

OYSTER BAYOU MARSH RESTORATION PROJECT
 STATE PROJECT NUMBER: CS-59
 FEDERAL PROJECT NUMBER: CS-59
 APPROVED BY: WT

ACCESS ROUTE "CL3"
 DATE: APRIL 13, 2016
 SHEET 65 OF 69

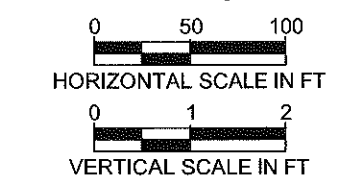
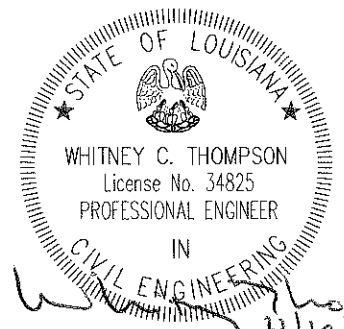
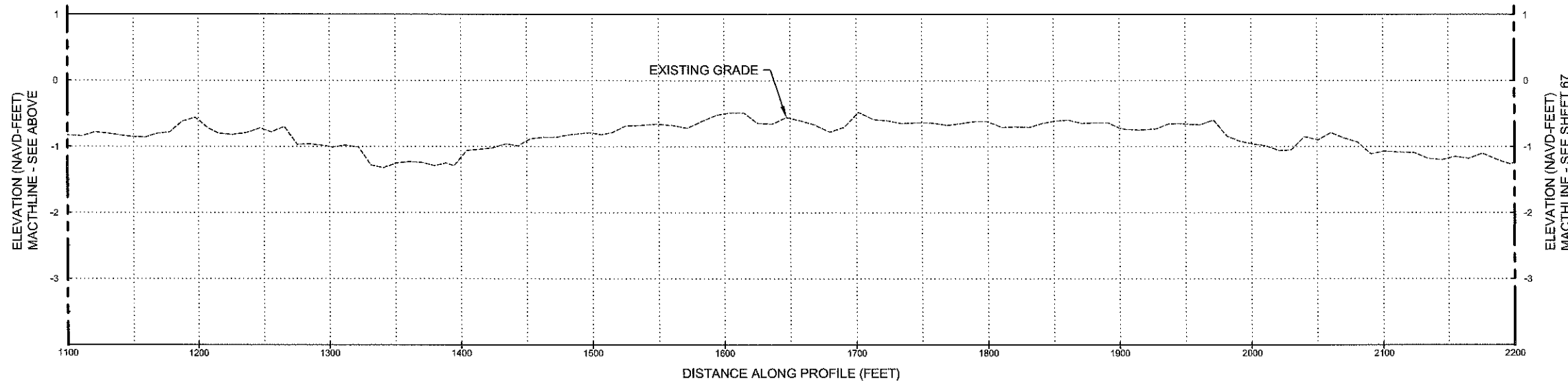
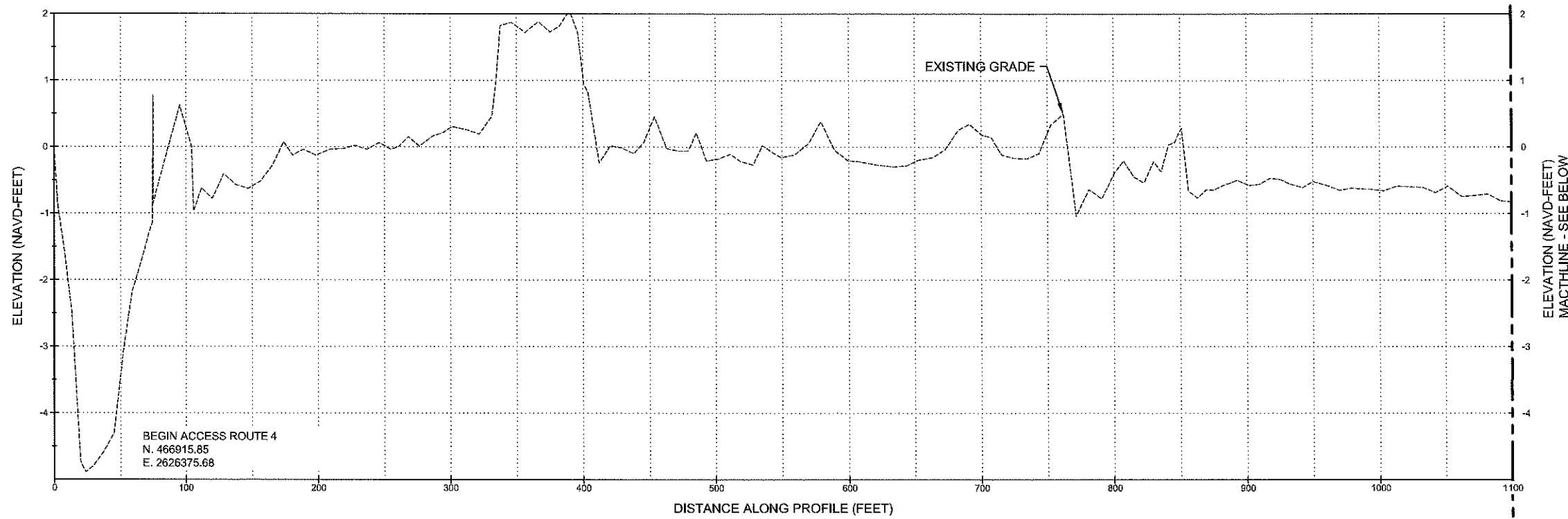

NOTES:

1. SURVEY ELEVATIONS SHOWN ON THE PLANS ARE FROM SURVEY DATA COLLECTED IN AUGUST AND SEPTEMBER 2012 BY LONNIE G. HARPER AND ASSOCIATES.
2. THE CONTRACTOR SHALL BE RESPONSIBLE FOR NAVIGATING FROM A NAVIGABLE WATER BODY TO THE PROJECT AREA. THE CONTRACTOR SHALL ALSO BE RESPONSIBLE FOR NAVIGATING WITHIN THE LIMITS OF THE PROJECT PLAN AREA. NO ACCESS DREDGING IS PERMITTED.

REV.	DATE	DESCRIPTION	BY

CB&I COASTAL PLANNING & ENGINEERING, INC.

2481 N.W. BOCA RATON BOULEVARD
BOCA RATON, FLORIDA 33431
PH. (561) 391-8102
FAX (561) 391-8116
C.O.A. FL. #4028
C.O.A. LA. #2531
www.CBI.COM

COASTAL PROTECTION AND RESTORATION AUTHORITY

450 LAUREL STREET
BATON ROUGE, LOUISIANA 70801

DRAWN BY: GK

DESIGNED BY: CP

OYSTER BAYOU MARSH RESTORATION PROJECT

STATE PROJECT NUMBER: CS-59

FEDERAL PROJECT NUMBER: CS-59

APPROVED BY: WT

ACCESS ROUTE "CL4"

DATE: APRIL 13, 2016

SHEET 66 OF 69

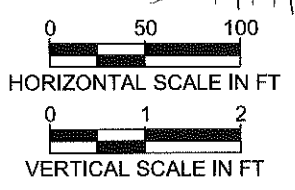
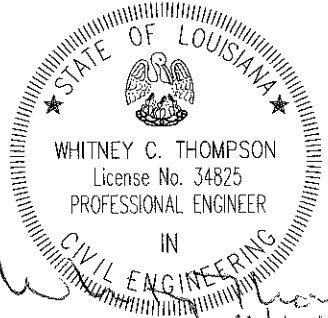
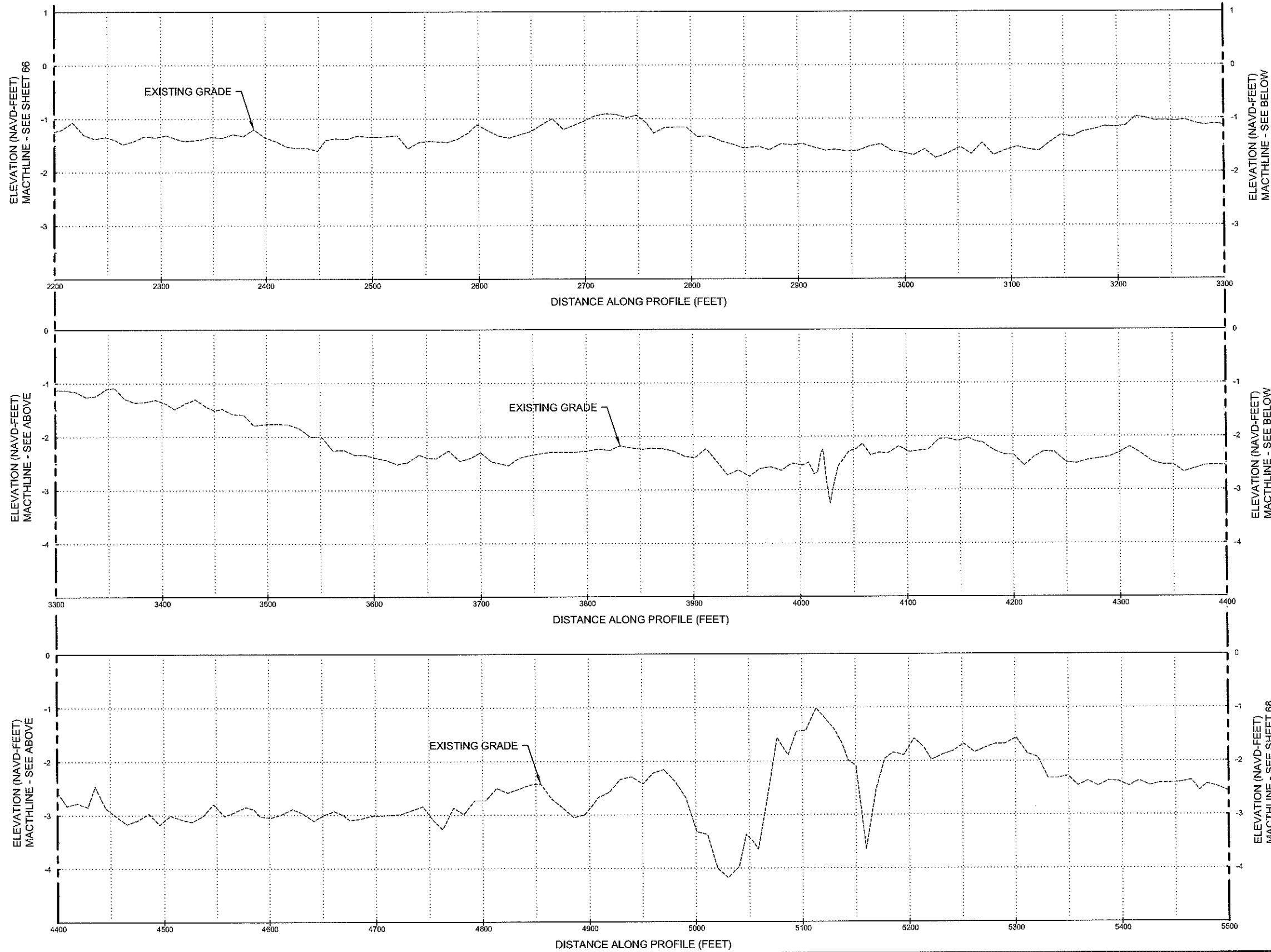

NOTES:

1. SURVEY ELEVATIONS SHOWN ON THE PLANS ARE FROM SURVEY DATA COLLECTED IN AUGUST AND SEPTEMBER 2012 BY LONNIE G. HARPER AND ASSOCIATES.
2. THE CONTRACTOR SHALL BE RESPONSIBLE FOR NAVIGATING FROM A NAVIGABLE WATER BODY TO THE PROJECT AREA. THE CONTRACTOR SHALL ALSO BE RESPONSIBLE FOR NAVIGATING WITHIN THE LIMITS OF THE PROJECT PLAN AREA. NO ACCESS DREDGING IS PERMITTED.

REV.	DATE	DESCRIPTION	BY

CB&I COASTAL PLANNING & ENGINEERING, INC.
 2481 N.W. BOCA RATON BOULEVARD
 BOCA RATON, FLORIDA 33431
 PH. (561) 391-8102
 FAX (561) 391-9116
 C.O.A. FL. #4028
 C.O.A. LA. #2531
 www.CBI.COM

COASTAL PROTECTION AND RESTORATION AUTHORITY
 450 LAUREL STREET
 BATON ROUGE, LOUISIANA 70801
 DRAWN BY: GK
 DESIGNED BY: CP

OYSTER BAYOU MARSH RESTORATION PROJECT
 STATE PROJECT NUMBER: CS-59
 FEDERAL PROJECT NUMBER: CS-59
 APPROVED BY: WT

ACCESS ROUTE "CL4"
 DATE: APRIL 13, 2016
 SHEET 67 OF 69

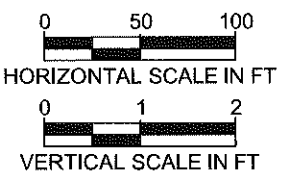
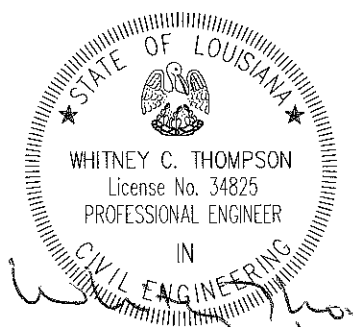
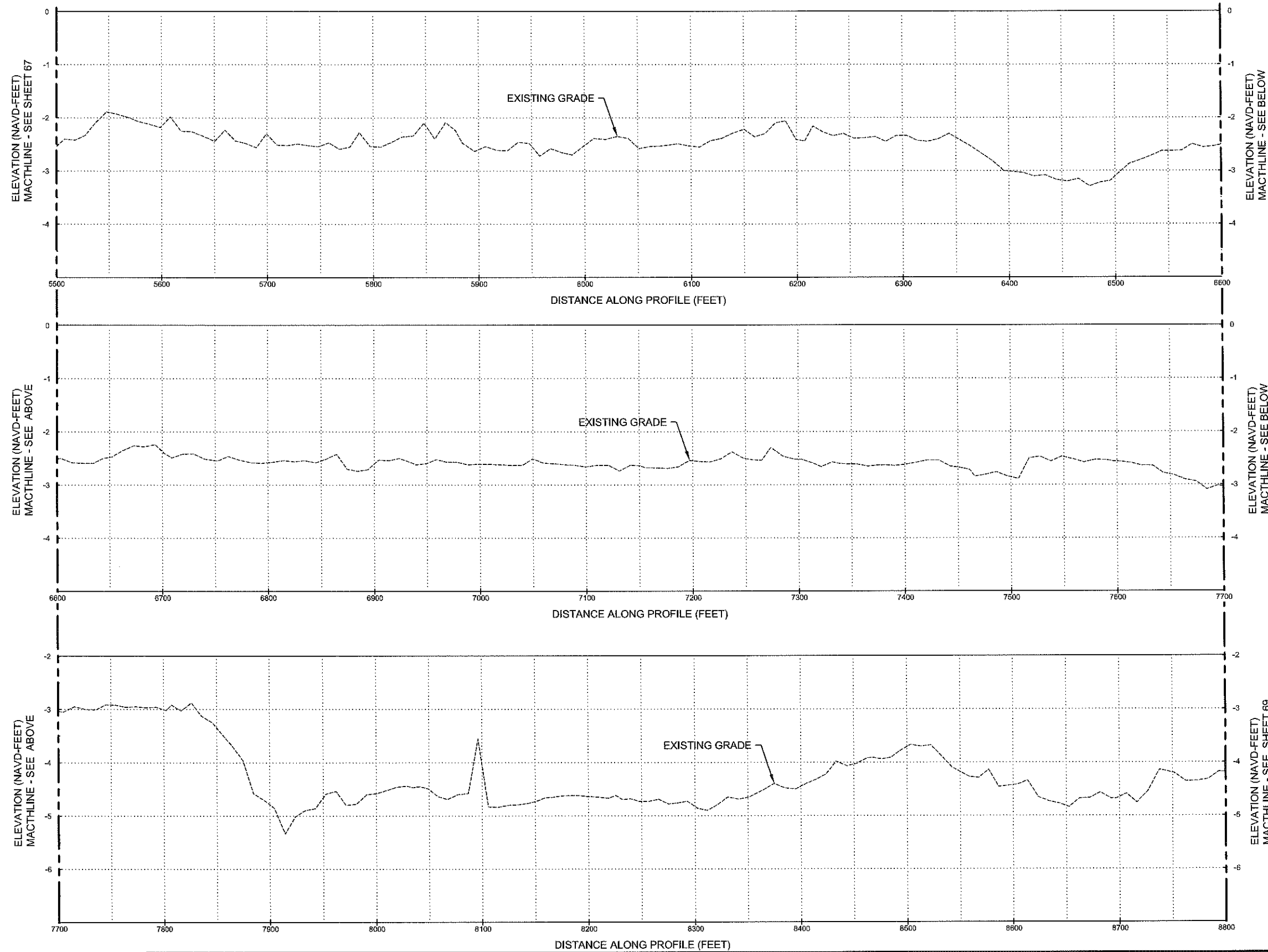

NOTES:

1. SURVEY ELEVATIONS SHOWN ON THE PLANS ARE FROM SURVEY DATA COLLECTED IN AUGUST AND SEPTEMBER 2012 BY LONNIE G. HARPER AND ASSOCIATES.
2. THE CONTRACTOR SHALL BE RESPONSIBLE FOR NAVIGATING FROM A NAVIGABLE WATER BODY TO THE PROJECT AREA. THE CONTRACTOR SHALL ALSO BE RESPONSIBLE FOR NAVIGATING WITHIN THE LIMITS OF THE PROJECT PLAN AREA. NO ACCESS DREDGING IS PERMITTED.

REV.	DATE	DESCRIPTION	BY

CB&I COASTAL PLANNING & ENGINEERING, INC.
 2481 N.W. BOCA RATON BOULEVARD
 BOCA RATON, FLORIDA 33431

PH. (561) 391-8102
 FAX (561) 391-8116

C.O.A. FL #4028
 C.O.A. LA #2631
 www.CBI.COM

COASTAL PROTECTION AND RESTORATION AUTHORITY

450 LAUREL STREET
 BATON ROUGE, LOUISIANA 70801

DRAWN BY: GK

DESIGNED BY: CP

OYSTER BAYOU MARSH RESTORATION PROJECT

STATE PROJECT NUMBER: CS-59

FEDERAL PROJECT NUMBER: CS-59

APPROVED BY: WT

ACCESS ROUTE "CL4"

DATE: APRIL 13, 2016

SHEET 68 OF 69

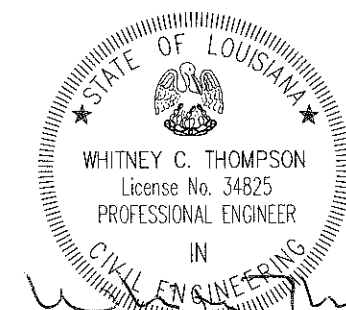
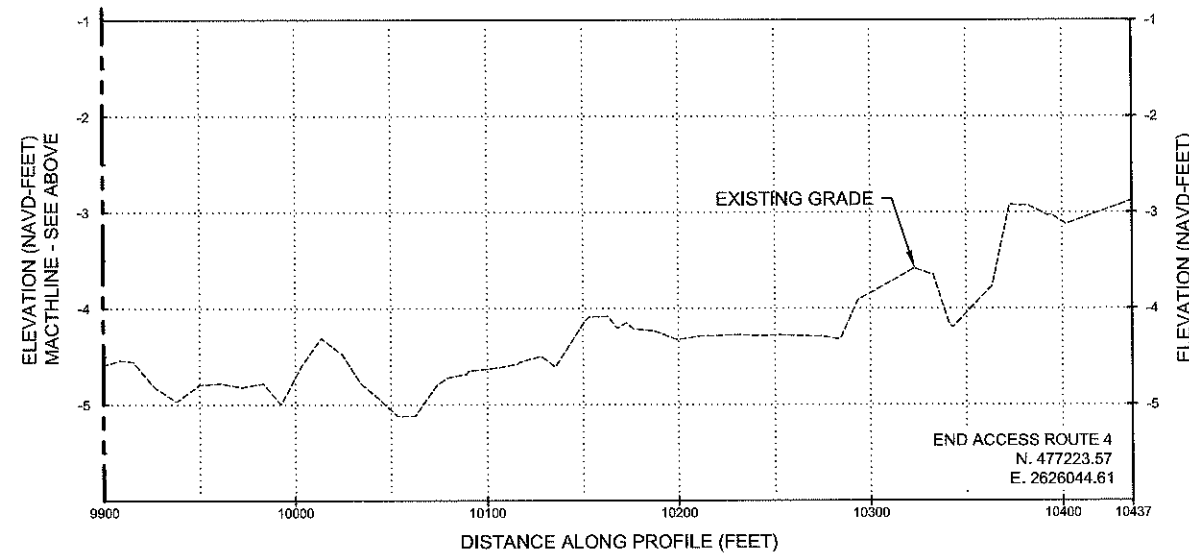
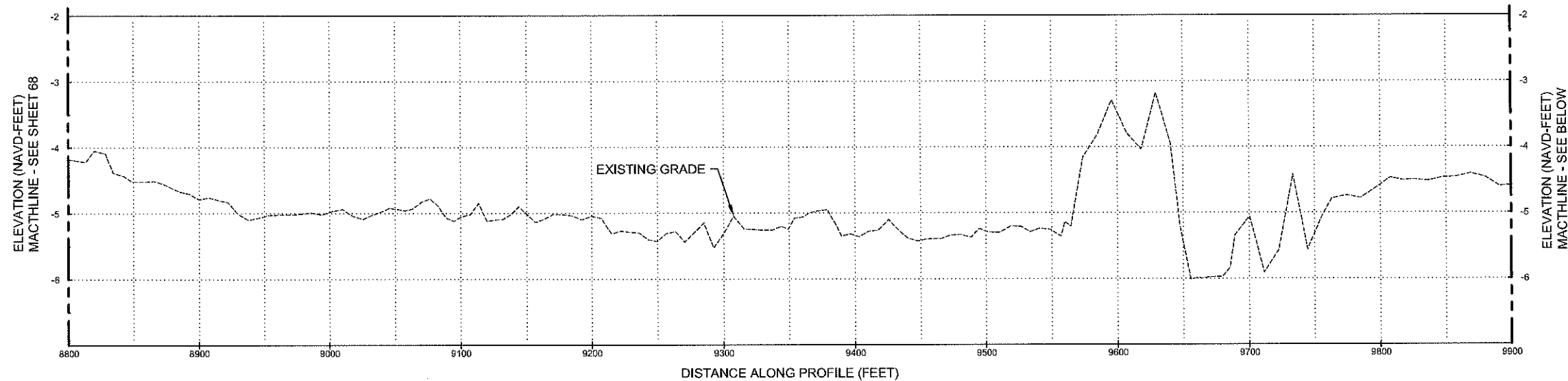

Whitney C. Thompson
4/19/16

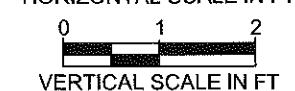
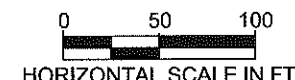

NOTES:

1. SURVEY ELEVATIONS SHOWN ON THE PLANS ARE FROM SURVEY DATA COLLECTED IN AUGUST AND SEPTEMBER 2012 BY LONNIE G. HARPER AND ASSOCIATES.
2. THE CONTRACTOR SHALL BE RESPONSIBLE FOR NAVIGATING FROM A NAVIGABLE WATER BODY TO THE PROJECT AREA. THE CONTRACTOR SHALL ALSO BE RESPONSIBLE FOR NAVIGATING WITHIN THE LIMITS OF THE PROJECT PLAN AREA. NO ACCESS DREDGING IS PERMITTED.

REV.	DATE	DESCRIPTION	BY

CB&I COASTAL PLANNING & ENGINEERING, INC.
 2481 N.W. BOCA RATON BOULEVARD
 BOCA RATON, FLORIDA 33431
 PH. (561) 391-8102
 FAX (561) 391-8116
 C.O.A. FL. #4028
 C.O.A. LA. #2531
 www.CBI.COM

COASTAL PROTECTION AND RESTORATION AUTHORITY
 450 LAUREL STREET
 BATON ROUGE, LOUISIANA 70801
 DRAWN BY: GK
 DESIGNED BY: CP

OYSTER BAYOU MARSH RESTORATION PROJECT
 STATE PROJECT NUMBER: CS-59
 FEDERAL PROJECT NUMBER: CS-59
 APPROVED BY: WT

ACCESS ROUTE "CL4"
 DATE: APRIL 13, 2016
 SHEET 69 OF 69